

# Specifications Guide

## Agilent Technologies PSA Series Spectrum Analyzers

**This manual provides documentation for the following instruments:**

**E4443A (3 Hz to 6.7 GHz)**

**E4445A (3 Hz to 13.2 GHz)**

**E4440A (3 Hz to 26.5 GHz)**

**E4447A (3 Hz to 42.98 GHz)**

**E4446A (3 Hz to 44GHz)**

**E4448A (3 Hz to 50 GHz)**



**Agilent Technologies**

**Manufacturing Part Number: E4440-90647**

**Supersedes: July 2012**

**Printed in USA**

**December 2012**

© Copyright 2001-2012 Agilent Technologies, Inc.

---

## Notice

The information contained in this document is subject to change without notice.

The following safety symbols are used throughout this manual. Familiarize yourself with the symbols and their meaning before operating this analyzer.

This product may contain remanufactured assemblies equivalent to new in performance and warranty.

---

## Warranty

This Agilent Technologies instrument product is warranted against defects in material and workmanship for a period of one year from date of shipment. During the warranty period, Agilent Technologies will, at its option, either repair or replace products that prove to be defective.

For warranty service or repair, this product must be returned to a service facility designated by Agilent Technologies. Buyer shall prepay shipping charges to Agilent Technologies and Agilent Technologies shall pay shipping charges to return the product to Buyer. However, Buyer shall pay all shipping charges, duties, and taxes for products returned to Agilent Technologies from another country.

Agilent Technologies warrants that its software and firmware designated by Agilent Technologies for use with an instrument will execute its programming instructions when properly installed on that instrument. Agilent Technologies does not warrant that the operation of the instrument, or software, or firmware will be uninterrupted or error-free.

---

## Limitation of Warranty

The foregoing warranty shall not apply to defects resulting from improper or inadequate maintenance by Buyer, Buyer-supplied software or interfacing, unauthorized modification or misuse, operation outside of the environmental specifications for the product, or improper site preparation or maintenance.

NO OTHER WARRANTY IS EXPRESSED OR IMPLIED. AGILENT TECHNOLOGIES SPECIFICALLY DISCLAIMS THE IMPLIED WARRANTIES OF MERCHANTABILITY AND FITNESS FOR A PARTICULAR PURPOSE.

---

## Exclusive Remedies

THE REMEDIES PROVIDED HEREIN ARE BUYER'S SOLE AND EXCLUSIVE REMEDIES. AGILENT TECHNOLOGIES SHALL NOT BE LIABLE FOR ANY DIRECT, INDIRECT, SPECIAL, INCIDENTAL, OR CONSEQUENTIAL DAMAGES, WHETHER BASED ON CONTRACT, TORT, OR ANY OTHER LEGAL THEORY.

---

<b>WARNING</b>	<i>Warning</i> denotes a hazard. It calls attention to a procedure which, if not correctly performed or adhered to, could result in injury or loss of life. Do not proceed beyond a warning note until the indicated conditions are fully understood and met.
----------------	---

---

---

<b>CAUTION</b>	<i>Caution</i> denotes a hazard. It calls attention to a procedure that, if not correctly performed or adhered to, could result in damage to or destruction of the product. Do not proceed beyond a caution note until the indicated conditions are fully understood and met.
----------------	---

---

---

<b>NOTE</b>	<i>Note</i> calls out special information for the user's attention. It provides operational information or additional instructions of which the user should be aware.
-------------	---

---

---

## Where to Find the Latest Information

Documentation is updated periodically. For the latest information about this analyzer, including firmware upgrades, application information, and product information, see the following URL:

<http://www.agilent.com/find/psa>



## 1. PSA Series Core Spectrum Analyzer

Definitions and Requirements . . . . .	16
Definitions . . . . .	16
Conditions Required to Meet Specifications . . . . .	16
Certification . . . . .	16
Frequency . . . . .	17
E4443A . . . . .	17
E4445A . . . . .	17
E4440A . . . . .	18
E4446A . . . . .	19
E4447A . . . . .	20
E4448A . . . . .	21
External Mixing (Option AYZ) . . . . .	22
Frequency Reference . . . . .	23
Frequency Readout Accuracy . . . . .	24
Frequency Counter Count Accuracy . . . . .	24
Delta Count Accuracy . . . . .	24
Resolution . . . . .	24
Frequency Span . . . . .	25
Sweep Trigger . . . . .	26
Gated FFT . . . . .	26
Gated Sweep . . . . .	27
Measurement Time vs. Span (nominal) . . . . .	29
Amplitude . . . . .	40
Gain Compression . . . . .	41
E4443A, E4445A, E4440A . . . . .	41
E4447A, E4446A, E4448A . . . . .	43
Displayed Average Noise Level (DANL) . . . . .	45
E4443A, E4445A, E4440A . . . . .	45
E4447A, E4446A, E4448A . . . . .	50
Display Range . . . . .	55
Marker Readout . . . . .	55
Frequency Response . . . . .	56
E4443A, E4445A, E4440A . . . . .	56
E4447A, E4446A, E4448A . . . . .	58
E4443A, E4445A, E4440A . . . . .	62
E4447A, E4446A, E4448A . . . . .	62
RF Input VSWR . . . . .	65
E4443A, E4445A, E4440A . . . . .	65
E4447A, E4446A, E4448A . . . . .	66
Relative Fidelity . . . . .	70
Available Detectors . . . . .	72
Second Harmonic Distortion . . . . .	74
Third Order Intermodulation Distortion . . . . .	76
E4443A, E4445A, E4440A . . . . .	76
E4447A, E4446A, E4448A . . . . .	78
Dynamic Range . . . . .	81
E4443A, E4445A, E4440A . . . . .	81
E4447A, E4446A, E4448A: Bands 0–4 . . . . .	82

E4447A, E4446A, E4448A: Bands 5–6 . . . . .	83
Power Suite Measurements . . . . .	84
Fast ACPR Test . . . . .	91
Options . . . . .	96
General . . . . .	97
Inputs/Outputs (Front Panel) . . . . .	101
RF Input . . . . .	101
E4443A, E4445A, E4440A . . . . .	101
E4447A, E4446A, E4448A . . . . .	101
Option AYZ External Mixing . . . . .	102
Rear Panel . . . . .	104
Regulatory Information . . . . .	109
Declaration of Conformity . . . . .	109
Compliance with German Noise Requirements . . . . .	110
Compliance with EMC Requirements . . . . .	110
<b>2. Phase Noise Measurement Personality</b>	
Option 226, Phase Noise Measurement Personality . . . . .	114
Carrier Frequency Range . . . . .	114
Measurement Characteristics . . . . .	114
Offset Frequency . . . . .	115
Measurement Accuracy . . . . .	115
Amplitude Repeatability . . . . .	116
Frequency Offset Accuracy . . . . .	117
<b>3. Noise Figure Measurement Personality</b>	
Option 219, Noise Figure Measurement Personality . . . . .	120
Noise Figure . . . . .	120
Gain . . . . .	126
Noise Figure Uncertainty Calculator . . . . .	127
<b>4. Digital Modulation Analysis Measurements Specifications</b>	
Signal Acquisition . . . . .	134
Trigger . . . . .	137
Supported data formats . . . . .	138
Filtering . . . . .	139
Symbol rate . . . . .	139
Accuracy . . . . .	140
<b>5. Digital Communications Basic Measurement Personality</b>	
Additional Definitions and Requirements . . . . .	146
Option B7J, Basic Measurement Personality . . . . .	146
Frequency Range . . . . .	146
Electronic Input Attenuator . . . . .	147
Absolute Amplitude Accuracy . . . . .	148
LO emissions < 3 GHz . . . . .	149
Third-order Intermodulation Distortion . . . . .	149

Displayed Average Noise Level .....	149
Measurement Range .....	149
Measurements .....	150
Spectrum .....	150
Waveform .....	151
Inputs and Outputs .....	153
Front Panel .....	153
RF Input .....	153
<b>6. GSM/EDGE Measurement Personality</b>	
Additional Definitions and Requirements .....	156
Option 202, GSM/EDGE .....	157
EDGE Error Vector Magnitude (EVM) .....	157
Power vs. Time .....	157
EDGE Power vs. Time .....	157
Power Ramp Relative Accuracy .....	158
Phase and Frequency Error .....	160
Output RF Spectrum .....	161
Dynamic Range .....	162
In-Band Frequency Ranges .....	164
Alternative Frequency Ranges .....	164
Trigger .....	165
Burst Sync .....	165
Range Control .....	165
<b>7. W-CDMA Measurement Personality</b>	
Additional Definitions and Requirements .....	168
Conformance With 3GPP TS 25.141 Base Station Requirements for a Manufacturing Environment. . .	169
Channel Power .....	172
Adjacent Channel Power Ratio (ACPR; ACLR) .....	173
Dynamic Range .....	175
Multi-Carrier Power .....	175
Power Statistics CCDF .....	175
Intermodulation .....	176
Occupied Bandwidth .....	177
Code Domain .....	178
QPSK EVM .....	182
Modulation Accuracy .....	184
Power Control and Power vs. Time .....	187
Frequency .....	188
In-Band Frequency Range .....	188
General .....	189
Trigger .....	189
Range Control .....	189

## 8.HSDPA/HSUPA Measurement Personality

Additional Definitions and Requirements .....	192
Option 210, HSDPA/HSUPA Measurement Personality .....	193
Code Domain .....	193
Modulation Accuracy (Composite EVM).....	196
Frequency .....	198
In-Band Frequency Range .....	198
General .....	199
Trigger.....	199
Range Control.....	199

## 9. cdmaOne Measurement Personality

Additional Definitions and Requirements .....	202
Option BAC, cdmaOne Measurements Personality .....	203
Channel Power Measurement.....	203
Code Domain (Base Station) .....	204
Modulation Accuracy .....	205
Adjacent Channel Power Ratio.....	206
Spur Close.....	208
In-Band Frequency Ranges.....	208

## 10. cdma2000 Measurement Personality

Additional Definitions and Requirements .....	210
Option B78, cdma2000 Measurement Personality.....	211
Channel Power .....	211
Adjacent Channel Power Ratio.....	212
Power Statistics CCDF.....	213
Intermodulation.....	214
Occupied Bandwidth.....	214
Spectrum Emission Mask .....	215
Code Domain .....	216
QPSK EVM .....	217
Modulation Accuracy (Composite Rho).....	218
In-Band Frequency Range Band Class 0 (North American Cellular).....	219
General .....	221
Trigger.....	221
Range Control.....	221

## 11. 1xEV-DV Measurement Personality

Additional Definitions and Requirements .....	224
Test model signal for 1xEV-DV .....	225
Option 214, 1xEV-DV Measurement Personality .....	226
Code Domain .....	226
Modulation Accuracy (Composite Rho).....	228



In-Band Frequency Range . . . . .	231
General . . . . .	232
Trigger . . . . .	232
Range Control . . . . .	232
<b>12. 1xEV-DO Measurement Personality</b>	
Additional Definitions and Requirements . . . . .	234
Option 204, 1xEV-DO Measurements Personality . . . . .	235
Channel Power . . . . .	235
Power Statistics CCDF . . . . .	236
Intermod . . . . .	236
Occupied Bandwidth . . . . .	236
Spurious Emissions and ACP . . . . .	237
Code Domain . . . . .	238
QPSK EVM . . . . .	238
Modulation Accuracy (Composite Rho) . . . . .	239
Power vs. Time (PvT) . . . . .	240
Frequency . . . . .	241
In-Band Frequency Range . . . . .	241
Alternative Frequency Ranges . . . . .	242
Alternative Frequency Ranges . . . . .	242
General . . . . .	243
Trigger . . . . .	243
Range Control . . . . .	243
<b>13. NADC Measurement Personality</b>	
Additional Definitions and Requirements . . . . .	246
Option BAE, NADC Measurement Personality . . . . .	247
Adjacent Channel Power Ratio . . . . .	247
Error Vector Magnitude (EVM) . . . . .	248
In-Band Frequency Range . . . . .	248
General . . . . .	249
Trigger . . . . .	249
Range Control . . . . .	249
<b>14. PDC Measurement Personality</b>	
Additional Definitions and Requirements . . . . .	252
Option BAE, PDC Measurement Personality . . . . .	253
Adjacent Channel Power Ratio . . . . .	253
Occupied Bandwidth . . . . .	254
In-Band Frequency Range . . . . .	254
General . . . . .	255
Trigger . . . . .	255
Range Control . . . . .	255

<b>15. TD-SCDMA Measurement Personality</b>	
Option 211, TD SCDMA Measurement Personality . . . . .	258
Power vs. Time . . . . .	258
Transmit Power . . . . .	258
Adjacent Channel Power . . . . .	259
Multi-Carrier Power . . . . .	259
Spurious Emissions . . . . .	260
<b>16. TD-SCDMA/HSDPA/8PSK Measurement Personalities</b>	
Additional Definitions and Requirements . . . . .	262
Measurement Specifications . . . . .	263
Code Domain . . . . .	263
Modulation Accuracy . . . . .	264
Frequency . . . . .	266
In-Band Frequency Range . . . . .	266
General . . . . .	266
Trigger . . . . .	266
Range Control . . . . .	266
<b>17. 40 MHz Bandwidth Digitizer - Option 140</b>	
Frequency . . . . .	268
Amplitude and Phase . . . . .	269
IF Frequency Response . . . . .	273
IF Phase Linearity . . . . .	275
EVM . . . . .	278
Dynamic Range . . . . .	279
Data Acquisition . . . . .	285
Wideband IF Triggering . . . . .	286
<b>18. 80 MHz Bandwidth Digitizer - Option 122</b>	
Frequency . . . . .	290
Nominal IF Bandwidth . . . . .	291
Amplitude and Phase . . . . .	292
IF Frequency Response . . . . .	296
IF Phase Linearity . . . . .	298
Amplitude and Phase, Continued . . . . .	301
Dynamic Range . . . . .	302
Data Acquisition . . . . .	308
Wideband IF Triggering . . . . .	309
<b>19. External Calibration Using Wide Bandwidth Digitizer Characteristics</b>	
IF Frequency Response . . . . .	312
IF Phase Linearity . . . . .	312
EVM . . . . .	313
Nominal IF Frequency Response . . . . .	314

<b>20. Switchable MW Preselector Bypass Specifications</b>	
Applicability of Specifications for this option	316
Specifications in other chapters	316
Option 123, Switchable MW Preselector Bypass	317
Frequency	317
Image Responses	317
Amplitude	318
E4443A, E4445A, E4440A	318
E4447A, E4446A, E4448A	320
Dynamic Range	323
First LO Emission Level	323
E4443A, E4445A, E4440A	323
E4447A, E4446A, E4448A	323
<b>21. Y-axis Video Output - Option 124</b>	
Applicability of Specification for this Option	326
Operating Conditions	326
Output Signal	327
Amplitude	328
Delay	329
Continuity and Compatibility	330
<b>22. W-LAN Measurement Personality</b>	
OFDM Analysis (802.11a, 802.11g OFDM)	332
Frequency	332
Amplitude	332
Signal Acquisition	333
Display Formats	334
Adjustable Parameters	335
Accuracy	336
DSSS/CCK/PBSS Analysis (802.11b, 802.11g)	338
Frequency	338
Amplitude	338
Signal Acquisition	339
Display Formats	340
Adjustable Parameters	341
Accuracy	342
Conformance for 802.11a and 802.11g ERP-OFDM/DSSS-OFDM Standard	344
Conformance for 802.11b and 802.11g ERP-DSSS/CCK/PBCC Standard	346
<b>23. External Source Control - Option 215</b>	
Frequency	348
Dynamic Range	349
Power sweep range	349
Measurement Time	350
Supported External Sources	351

## 24. EMI Receiver Specifications: PSA and N9039A RF Preselector

Applicability of Specifications for this Option	354
Requirements for PSA based EMI Receiver	355
Conditions Required to Meet Specifications	355
Frequency	356
CISPR Band	357
Sweep Time vs. Span	358
Amplitude	359
Maximum Safe Input Level	360
Measurement Range	361
Gain Compression	362
Displayed Average Noise Level (DANL)	363
Absolute Amplitude Accuracy	364
RF Preselector Gain & Noise Figure	366
General Spurious Responses	367
Second Harmonic Distortion	368
RF Preselector Third Order Intercept	369
Residual Responses	370
N9039A RF Preselector Specifications	371
Calibration Cycle	371
Model and Option listings	371
Pre-selection Filters	372
Inputs and Outputs	373
Temperature Range	374
Environmental and Military Specifications	374
EMC	374
Safety	375
Power Requirements	375
Dimensions	376
Weight	376
Displays	376

## 25. Measuring Receiver Personality

Additional Definitions and Requirements	378
PSA Conditions Required to Meet Specifications	378
Frequency Modulation	379
Input Power Range	379
AM Rejection (50 Hz to 3 kHz BW)	380
Residual FM (50 Hz to 3 kHz BW)	381
Amplitude Modulation	382
Input Power Range	382
AM Depth Accuracy	382
Flatness	383
FM Rejection (50 Hz to 3 kHz BW)	384
Phase Modulation	385
Input Power Range	385
Maximum Peak Phase Deviation	385
AM Rejection (50 Hz to 3 kHz BW)	387
Residual PM (50 Hz to 3 kHz BW)	387

Modulation Rate . . . . .	388
Frequency Range . . . . .	388
Modulation Rate Accuracy . . . . .	388
Modulation Distortion . . . . .	389
Modulation Rate . . . . .	389
Accuracy . . . . .	389
Residual Noise and Distortion . . . . .	389
PM . . . . .	390
FM . . . . .	391
Modulation SINAD . . . . .	392
Residual Noise and Distortion . . . . .	393
Modulation Filters . . . . .	395
RF Frequency Counter . . . . .	396
Audio Input . . . . .	397
Audio Frequency Counter <b>1</b> . . . . .	397
Audio AC (RMS) Level <b>1</b> . . . . .	398
Audio Distortion . . . . .	398
Audio SINAD <b>1</b> . . . . .	398
Audio Filters . . . . .	399
RF Power . . . . .	400
Input SWR . . . . .	402
Power Reference (P-Series, EPM and EPM-P Series Specifications) . . . . .	404
Tuned RF Level Specification Nomenclature . . . . .	405
Tuned RF Level . . . . .	406
Minimum Power (dBm)	
Frequency Range . . . . .	408
Absolute Measurement Accuracy . . . . .	410
Power Meter Range Uncertainty . . . . .	412
Power Meter Range Uncertainty . . . . .	413
Information about Residuals . . . . .	414
Graphical Relative Measurement Accuracy Specifications (Nominal) . . . . .	41



---

# **1            PSA Series Core Spectrum Analyzer**

This chapter contains the specifications for the core spectrum analyzer. The specifications and characteristics for the measurement personalities and options are covered in the chapters that follow.

## Definitions and Requirements

This book contains specifications and supplemental information for the PSA Series spectrum analyzers. The distinction among specifications, typical performance, and nominal values are described as follows.

### Definitions

- Specifications describe the performance of parameters covered by the product warranty (temperature = 0 to 55 °C, unless otherwise noted).
- Typical describes additional product performance information that is not covered by the product warranty. It is performance beyond specification that 80 % of the units exhibit with a 95 % confidence level over the temperature range 20 to 30 °C. Typical performance does not include measurement uncertainty.
- Nominal values indicate expected performance, or describe product performance that is useful in the application of the product, but is not covered by the product warranty.

The following conditions must be met for the analyzer to meet its specifications.

### Conditions Required to Meet Specifications

- The analyzer is within its calibration cycle. See the General chapter.
- Front-panel 1<sup>st</sup> LO OUT connector terminated in 50 Ohms. (If Option AYZ is installed.)
- Under auto couple control, except that Auto Sweep Time = Accy.
- For center frequencies < 20 MHz, DC coupling applied.
- At least 2 hours of storage or operation at the operating temperature.
- Analyzer has been turned on at least 30 minutes with Auto Align On selected, or

If Auto Align Off is selected, Align All Now must be run:

- Within the last 24 hours, and
- Any time the ambient temperature changes more than 3 °C, and
- After the analyzer has been at operating temperature at least 2 hours.

### Certification

Agilent Technologies certifies that this product met its published specifications at the time of shipment from the factory. Agilent Technologies further certifies that its calibration measurements are traceable to the United States National Institute of Standards and Technology, to the extent allowed by the Institute's calibration facility, and to the calibration facilities of other International Standards Organization members.



## Frequency

### E4443A

Description	Specifications	Supplemental Information
<b>Frequency Range</b>		
DC Coupled	3 Hz to 6.7 GHz	
AC Coupled	20 MHz to 6.7 GHz	
Internal Mixing Bands		Harmonic Mixing Mode (N) <sup>a</sup>
0	3 Hz to 3.0 GHz (DC Coupled)	1–
0	20 MHz to 3.0 GHz (AC Coupled)	1–
1	2.85 to 6.6 GHz	1–
2	6.2 to 6.7 GHz	2–

- a. N is the harmonic mixing mode. All mixing modes are negative (as indicated by the “–”), where the desired first LO harmonic is higher than the tuned frequency by the first IF (3.9214 GHz for the 3 Hz to 3.0 GHz band, 321.4 MHz for all other bands).

### E4445A

Description	Specifications	Supplemental Information
<b>Frequency Range</b>		
DC Coupled	3 Hz to 13.2 GHz	
AC Coupled	20 MHz to 13.2 GHz	
Internal Mixing Bands		Harmonic Mixing Mode (N) <sup>a</sup>
0	3 Hz to 3.0 GHz (DC Coupled)	1–
0	20 MHz to 3.0 GHz (AC Coupled)	1–
1	2.85 to 6.6 GHz	1–
2	6.2 to 13.2 GHz	2–

- a. N is the harmonic mixing mode. All mixing modes are negative (as indicated by the “–”), where the desired first LO harmonic is higher than the tuned frequency by the first IF (3.9214 GHz for the 3 Hz to 3.0 GHz band, 321.4 MHz for all other bands).

**E4440A**

Description	Specifications	Supplemental Information
<b>Frequency Range</b>		
DC Coupled	3 Hz to 26.5 GHz	
AC Coupled	20 MHz to 26.5 GHz	
Internal Mixing Bands		Harmonic Mixing Mode (N) <sup>a</sup>
0	3 Hz to 3.0 GHz (DC Coupled)	1-
0	20 MHz to 3.0 GHz (AC Coupled)	1-
1	2.85 to 6.6 GHz	1-
2	6.2 to 13.2 GHz	2-
3	12.8 to 19.2 GHz	4-
4	18.7 to 26.5 GHz	4-

a. N is the harmonic mixing mode. All mixing modes are negative (as indicated by the “-”), where the desired first LO harmonic is higher than the tuned frequency by the first IF (3.9214 GHz for the 3 Hz to 3.0 GHz band, 321.4 MHz for all other bands).

**E4446A**

Description	Specifications	Supplemental Information
<b>Frequency Range</b>		
DC Coupled	3 Hz to 44.0 GHz	
Internal Mixing Bands		Harmonic Mixing Mode (N) <sup>a</sup>
0	3 Hz to 3.0 GHz	1–
1	2.85 to 6.6 GHz	1–
2	6.2 to 13.2 GHz	2–
3	12.8 to 19.2 GHz	4–
4	18.7 to 26.8 GHz	4–
5	26.4 to 31.15 GHz	4+
6	31.0 to 44.0 GHz	8–

- a. N is the harmonic mixing mode. Most mixing modes are negative (as indicated by the “–”), where the desired first LO harmonic is higher than the tuned frequency by the first IF (3.9214 GHz for Bands 0, 5 and 6, 321.4 MHz for all other bands). A positive mixing mode (indicated by “+”) is one in which the tuned frequency is higher than the desired first LO harmonic by the first IF (3.9214 GHz for band 5).

**E4447A**

Description	Specifications	Supplemental Information
<b>Frequency Range</b>		
DC Coupled	3 Hz to 42.98 GHz	
Internal Mixing Bands		Harmonic Mixing Mode (N) <sup>a</sup>
0	3 Hz to 3.0 GHz	1–
1	2.85 to 6.6 GHz	1–
2	6.2 to 13.2 GHz	2–
3	12.8 to 19.2 GHz	4–
4	18.7 to 26.8 GHz	4–
5	26.4 to 31.15 GHz	4+
6	31.0 to 42.98 GHz	8–

- a. N is the harmonic mixing mode. Most mixing modes are negative (as indicated by the “–”), where the desired first LO harmonic is higher than the tuned frequency by the first IF (3.9214 GHz for Bands 0, 5 and 6, 321.4 MHz for all other bands). A positive mixing mode (indicated by “+”) is one in which the tuned frequency is higher than the desired first LO harmonic by the first IF (3.9214 GHz for band 5).

**E4448A**

Description	Specifications	Supplemental Information
<b>Frequency Range</b>		
DC Coupled	3 Hz to 50.0 GHz	
Internal Mixing Bands		Harmonic Mixing Mode (N) <sup>a</sup>
0	3 Hz to 3.0 GHz	1–
1	2.85 to 6.6 GHz	1–
2	6.2 to 13.2 GHz	2–
3	12.8 to 19.2 GHz	4–
4	18.7 to 26.8 GHz	4–
5	26.4 to 31.15 GHz	4+
6	31.0 to 50.0 GHz	8–

- a. The low frequency range of the *Option 1DS* preamp extends to 100 kHz when the RF coupling is set to DC, and to 10 MHz when RF coupling is set to AC. The *Option 110* preamp goes down to 10 MHz.

### External Mixing (Option AYZ)

Description	Specifications		Supplemental Information
<b>Frequency Range</b> External Mixing <i>Option AYZ</i>	18 GHz to 325 GHz		
	<b>Harmonic Mixing Mode (N<sup>a</sup>)</b>		
<b>Band</b>	<b>Preselected</b>	<b>Unpreselected</b>	
K (18.0 GHz to 26.5 GHz)	n/a	6–	
A (26.5 GHz to 40.0 GHz)	8+	8–	
Q (33.0 GHz to 50.0 GHz)	10+	10–	
U (40.0 GHz to 60.0 GHz)	10+	10–	
V (50.0 GHz to 75.0 GHz)	14+	14–	
E (60.0 GHz to 90.0 GHz)	n/a	16–	
W (75.0 GHz to 110.0 GHz)	n/a	18–	
F (90.0 GHz to 140.0 GHz)	n/a	22–	
D (110.0 GHz to 170.0 GHz)	n/a	26–	
G (140.0 GHz to 220.0 GHz)	n/a	32–	
Y (170.0 GHz to 260.0 GHz)	n/a	38–	
J (220.0 GHz to 325.0 GHz)	n/a	48–	

a. N is the harmonic mixing mode. For negative mixing modes (as indicated by the “–”), the desired 1st LO harmonic is higher than the tuned frequency by the 1st IF (321.4 MHz for all external mixing bands) For positive mixing modes, the desired 1st LO harmonic is lower than the tuned frequency by 321.4 MHz.

Description	Specifications	Supplemental Information
<b>Frequency Reference</b>		
Accuracy	$\pm[(\text{time since last adjustment} \times \text{aging rate}) + \text{temperature stability} + \text{calibration accuracy}^{\text{a}}]$	
Temperature Stability		
20 to 30 °C	$\pm 1 \times 10^{-8}$	
0 to 55 °C	$\pm 5 \times 10^{-8}$	
Aging Rate		$\pm 5 \times 10^{-10}/\text{day}$ (nominal)
Total Aging		
1 Year	$\pm 1 \times 10^{-7}$	
2 Years	$\pm 1.5 \times 10^{-7}$	
Settability	$\pm 2 \times 10^{-9}$	
Warm-up and Retrace <sup>b</sup>		
300 s after turn on		$\pm 1 \times 10^{-7}$ of final frequency (nominal)
900 s after turn on		$\pm 5 \times 10^{-8}$ of final frequency (nominal)
Achievable Initial Calibration Accuracy <sup>c</sup>	$\pm 7 \times 10^{-8}$	

- a. Calibration accuracy depends on how accurately the frequency standard was adjusted to 10 MHz. If the calibration procedure is followed, the calibration accuracy is given by the specification “Achievable Initial Calibration Accuracy.”
- b. Only applies when the power is disconnected from instrument. Does not apply when instrument is in standby mode.
- c. The achievable calibration accuracy at the beginning of the calibration cycle includes these effects:
  - 1) The temperature difference between the calibration environment and the use environment
  - 2) The orientation relative to the gravitation field changing between the calibration environment and the use environment
  - 3) Retrace effects in both the calibration environment and the use environment due to unplugging the instrument
  - 4) Settability

PSA Series Core Spectrum Analyzer  
Frequency

Description	Specifications	Supplemental Information
<b>Frequency Readout Accuracy</b>	$\pm(\text{marker freq.} \times \text{freq. ref. accy} + 0.25 \% \times \text{span} + 5 \% \times \text{RBW}^{\text{a}} + 2 \text{ Hz} + 0.5 \times \text{horizontal resolution}^{\text{b}})$	See note <sup>c</sup>
<b>Frequency Counter<sup>d</sup> Count Accuracy</b>	$\pm(\text{marker freq.} \times \text{freq. Ref. Accy.} + 0.100 \text{ Hz})$	See note <sup>e</sup>
<b>Delta Count Accuracy</b>	$\pm(\text{delta freq.} \times \text{freq. Ref. Accy.} + 0.141 \text{ Hz})$	
<b>Resolution</b>	0.001 Hz	

- a. The warranted performance is only the sum of all errors under autocoupled conditions. Under non-autocoupled conditions, the frequency readout accuracy will nominally meet the specification equation, except for conditions in which the RBW term dominates, as explained in examples below. The nominal RBW contribution to frequency readout accuracy is 2 % of RBW for RBWs from 1 Hz to 1 MHz, 3 % of RBW from 1.1 MHz through 3 MHz (the widest autocoupled RBW), and 30 % of RBW for the (manually selected) 4, 5, 6 and 8 MHz RBWs.  
First example: a 120 MHz span, with autocoupled RBW. The autocoupled ratio of span to RBW is 106:1, so the RBW selected is 1.1 MHz. The 5 %  $\times$  RBW term contributes only 55 kHz to the total frequency readout accuracy, compared to 300 kHz for the 0.25 %  $\times$  span term, for a total of 355 kHz. In this example, if an instrument had an unusually high RBW centering error of 7 % of RBW (77 kHz) and a span error of 0.20 % of span (240 kHz), the total actual error (317 kHz) would still meet the computed specification (355 kHz).  
Second example: a 20 MHz span, with a 4 MHz RBW. The specification equation does not apply because the Span: RBW ratio is not autocoupled. If the equation did apply, it would allow 50 kHz of error (0.25 %) due to the span and 200 kHz error (5 %) due to the RBW. For this non-autocoupled RBW, the RBW error is nominally 30 %, or 1200 kHz.
- b. Horizontal resolution is due to the marker reading out one of the trace points. The points are spaced by  $\text{span}/(\text{Npts} - 1)$ , where Npts is the number of sweep points. For example, with the factory preset value of 601 sweep points, the horizontal resolution is  $\text{span}/600$ . However, there is an exception: When both the detector mode is “normal” and the  $\text{span} > 0.25 \times (\text{Npts} - 1) \times \text{RBW}$ , peaks can occur only in even-numbered points, so the effective horizontal resolution becomes doubled, or  $\text{span}/300$  for the factory preset case. When the RBW is autocoupled and there are 601 sweep points, that exception occurs only for spans  $> 450$  MHz.
- c. Swept (not FFT) spans  $< 2$  MHz show a non-linearity in the frequency location at the right or left edge of the span of up to 1.4 % of span per megahertz of span (unless using the “fast tuning” option for phase noise optimization). This non-linearity is corrected in the marker readout. Traces output to a remote computer will show the nonlinear relationship between frequency and trace point number. This non-linearity does not occur if the phase noise optimization is set to Fast Tuning.
- d. Instrument conditions: RBW = 1 kHz, gate time = auto (100 ms), S/N  $\geq 50$  dB, frequency = 1 GHz
- e. If the signal being measured is locked to the same frequency reference as the analyzer, the specified count accuracy is  $\pm 0.100$  Hz under the test conditions of footnote d. This error is a noisiness of the result. It will increase with noisy sources, wider RBWs, lower S/N ratios, and source frequencies  $> 1$  GHz.



Description	Specifications	Supplemental Information
<b>Frequency Span</b>  Range Swept and FFT  E4443A  E4445A  E4440A  E4447A  E4446A  E4448A  Resolution  Span Accuracy  Swept  FFT	0 Hz, 10 Hz to 6.7 GHz  0 Hz, 10 Hz to 13.2 GHz  0 Hz, 10 Hz to 26.5 GHz  0 Hz, 10 Hz to 42.98 GHz  0 Hz, 10 Hz to 44 GHz  0 Hz, 10 Hz to 50 GHz  2 Hz          $\pm(0.2\% \times \text{span} + \text{horizontal resolution}^a)$  $\pm(0.2\% \times \text{span} + \text{horizontal resolution}^a)$	See note <sup>b</sup>

- a. Horizontal resolution is due to the marker reading out one of the trace points. The points are spaced by  $\text{span}/(\text{Npts} - 1)$ , where Npts is the number of sweep points. For example, with the factory preset value of 601 sweep points, the horizontal resolution is  $\text{span}/600$ . However, there is an exception: When both the detector mode is “normal” and the  $\text{span} > 0.25 \times (\text{Npts} - 1) \times \text{RBW}$ , peaks can occur only in even-numbered points, so the effective horizontal resolution becomes doubled, or  $\text{span}/300$  for the factory preset case. When the RBW is auto coupled and there are 601 sweep points, that exception occurs only for spans  $> 450$  MHz.
- b. Swept (not FFT) spans  $< 2$  MHz show a non-linearity in the frequency location at the right or left edge of the span of up to 1.4 % of span per megahertz of span (unless using the “fast tuning” option for phase noise optimization). This non-linearity is corrected in the marker readout. Traces output to a remote computer will show the nonlinear relationship between frequency and trace point number. This non-linearity does not occur if the phase noise optimization is set to Fast Tuning.



Description	Specifications	Supplemental Information
<b>Gated Sweep</b>		
Span Range	Any span	
Gate Delay Range	0 to 500.0 ms	
Gate Delay Settability	4 digits, $\geq 100$ ns	
Gate Delay Jitter		33.3 ns p-p (nominal)
Gate Length Range	10.0 $\mu\text{s}^{\text{a}}$ to 500.0 ms	
Gated Freq Readout Errors <sup>b</sup>		
At seams <sup>c</sup>		$\pm 0.2$ % of span $\times$ N (nominal)
Short Gate Length <sup>d</sup>		$\pm 0.2$ % of span $\times$ N (nominal)
Gated Amplitude Errors		Normal <sup>e</sup> Accy <sup>e</sup>
Low band <sup>f</sup>		$\pm 0.5$ dB $\pm 0.05$ dB
High band <sup>g</sup>		$\pm 5$ dB $\pm 2$ dB
Gate Sources		Pos or neg edge triggered
Ext Front or Rear		Thresholds independently settable over $\pm 5$ V range (nominal)
RF Burst (Wideband)		Threshold $-22$ dB relative to peak (nominal); $\pm 20$ MHz bandwidth (nominal)

- a. Gate lengths of 15 ms or less give increased amplitude errors in bands 1 through 4.
- b. Additional errors in frequency readout occur due to LO Gating. These errors are in addition to those described in the Frequency Readout Uncertainty specification.
- c. Errors occur at the seams in Gated LO measurements. These seams occur at the point where the LO stops (at the end of the gate length) and restarts. An exception to the listed nominal performance occurs when the LO mode is single-loop narrow and the span is 2 to 3 MHz inclusive. In single-loop narrow mode, the error is nominally  $\pm 6$  kHz, which is  $\pm 0.3$  % of span or less. Single-loop narrow mode occurs whenever the Span is  $\geq 2$  MHz and the Phase Noise Optimization is set to either "Optimize Phase Noise for  $f < 50$  kHz" or "Optimize Phase Noise for  $f > 50$  kHz." All errors are multiplied by N, the harmonic mixing number.
- d. Short gate lengths cause frequency location inaccuracies that accumulate randomly with increasing numbers of seams. The standard deviation of the frequency error can nominally be described as  $200 \text{ ns} \times N \times (\text{Span} / \text{SweepTime}) \times \sqrt{(\text{SpanPosition} \times \text{SweepTime} / \text{GateLength})}$ . In this expression, Span-Position is the location of the signal across the screen, with 0 being the left edge and 1 being the right edge of the span. For a sweep time of 5 ms (such as a 10 MHz to 3 GHz span) and a gate length of 10 ms, this expression evaluates to a standard deviation of 0.09 % of span. N is the harmonic mixing number.

## PSA Series Core Spectrum Analyzer Frequency

- e. The “Normal” and “Accy” columns refer to the sweep times selected when the sweep time is set to Auto and the “Auto Sweep Time” key is set to normal or accuracy. The specifications in these columns are nominal.
- f. Additional amplitude errors occur due to LO Gating. In band 0 (frequencies under 3 GHz), these errors occur at the seams in Gated LO measurements. These seams occur at the point where the LO stops (at the end of the gate length) and restarts. The size of these errors depends on the sweep rate. For example, with  $RBW = VBW$ , the error nominally is within  $\pm 0.63 \text{ dB} \times \text{Span} / (\text{Sweeptime} \times RBW^2)$ .
- g. Additional errors due to LO Gating in high band (above 3 GHz) occur due to high sweep rates of the YIG-tuned preselector (YTF). The autocoupled sweep rate is reduced in high band when gating is turned on in order to keep errors from exceeding those shown. With gating off, YTF sweep rates may go as high as 400 to 600 MHz/ms. With gating on, these rates are reduced to 100 MHz/ms (Normal) and 50 MHz/ms (Accy) below 19.2 GHz and half that for 19.2 to 26.5 GHz. Furthermore, additional errors of 10 dB and more can occur for Gate Lengths under 15 ms.

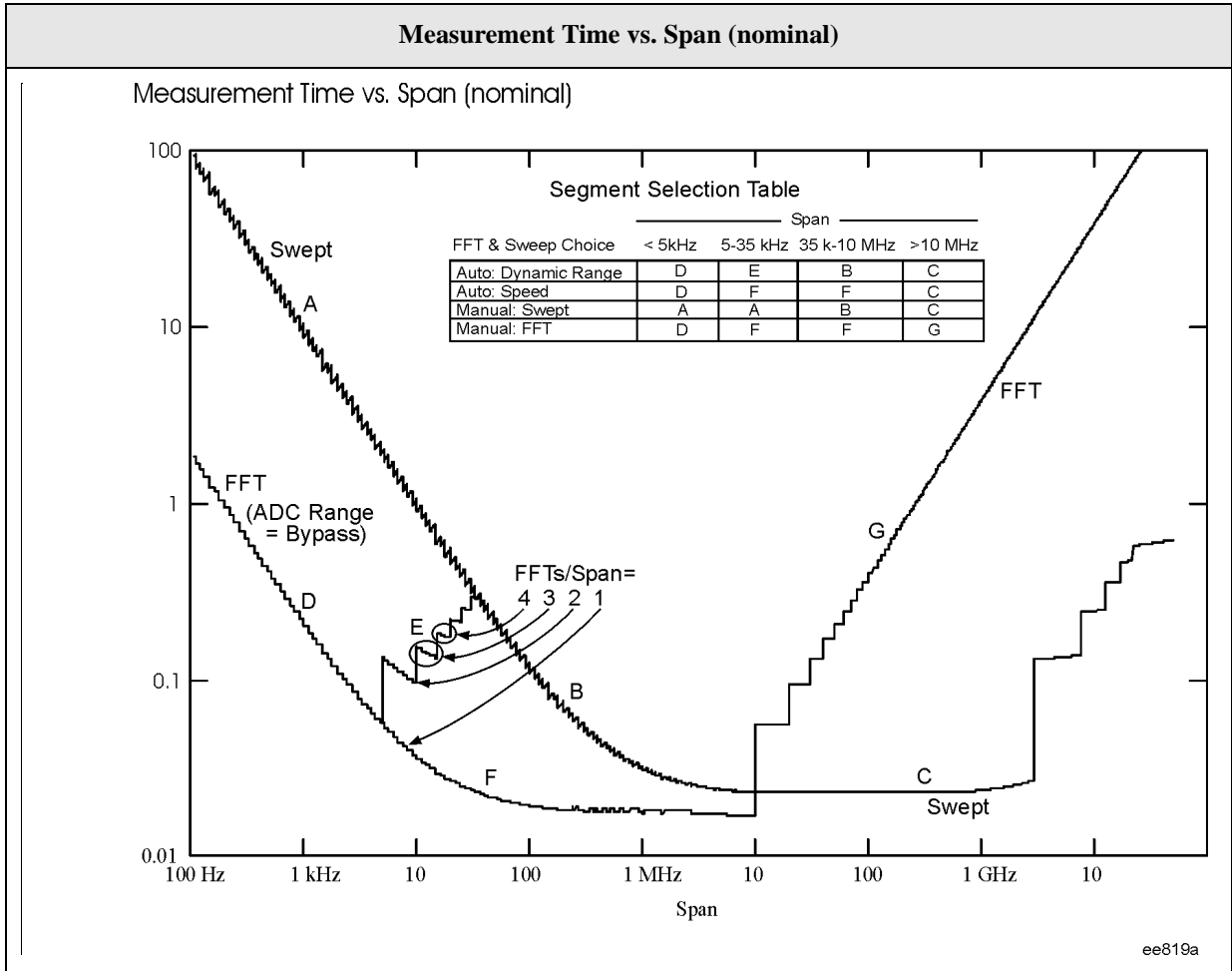

Description	Specifications	Supplemental Information
<b>Number of Frequency Display Trace Points (buckets)</b>		
Factory preset	601	
Range		
Span ≥ 10 Hz	101 to 8192	
Span = 0 Hz	2 to 8192	

PSA Series Core Spectrum Analyzer  
Frequency

Description	Specifications	Supplemental Information
<b>Resolution Bandwidth (RBW)</b>		
Range (–3.01 dB bandwidth)	1 Hz to 8 MHz. Bandwidths > 3 MHz = 4, 5, 6, and 8 MHz. Bandwidths 1 Hz to 3 MHz are spaced at 10 % spacing, 24 per decade: 1.0, 1.1, 1.2, 1.3, 1.5, 1.6, 1.8, 2.0, 2.2, 2.4, 2.7, 3.0, 3.3, 3.6, 3.9, 4.3, 4.7, 5.1, 5.6, 6.2, 6.8, 7.5, 8.2, 9.1, and repeat, times ten to an integer.	
Power bandwidth accuracy <sup>a b</sup>		
<b>RBW Range</b>	<b>CF Range</b>	
1 Hz – 51 kHz	All	±0.5 %
56 – 100 kHz	All	±1.0 %
110 – 240 kHz	All	±0.5 %
270 kHz – 1.1 MHz	<3 GHz	±1.5 %
1.2 – 2.0 MHz	<3 GHz	
2.2 – 6 MHz	<3 GHz	
		Equivalent to ±0.022 dB
		Equivalent to ±0.044 dB
		Equivalent to ±0.022 dB
		Equivalent to ±0.066 dB
		±0.07 dB (nominal)
		±0.2 dB (nominal)

- a. The noise marker, band power marker, channel power and ACP all compute their results using the power bandwidth of the RBW used for the measurement. Power bandwidth accuracy is the power uncertainty in the results of these measurements due only to bandwidth-related errors. (The analyzer knows this power bandwidth for each RBW with greater accuracy than the RBW width itself, and can therefore achieve lower errors.)
- b. Instruments with serial numbers of MY44300000 or higher, or US44300000 or higher, or SG44300000 or higher meet these specifications. Earlier instruments meet ±0.5 % from 82 to 330 kHz and ±1.0 % from 360 kHz to 1.1 MHz.

Description	Specifications	Supplemental Information
Accuracy (–3.01 dB bandwidth) <sup>a</sup> 1 Hz to 1.5 MHz RBW 1.6 MHz to 3 MHz RBW (CF ≤ 3 GHz) (CF > 3 GHz) 4 MHz to 8 MHz RBW (CF ≤ 3 GHz) (CF > 3 GHz) Selectivity (–60 dB/–3 dB)		±2 % (nominal) ±7 % (nominal) ±8 % (nominal) ±15 % (nominal) ±20 % (nominal) 4.1:1 (nominal)

- a. Resolution Bandwidth Accuracy can be observed at slower sweep times than autocoupled conditions. Normal sweep rates cause the shape of the RBW filter displayed on the analyzer screen to widen by nominally 6 %. This widening declines to 0.6 % nominal when the Auto Swp Time key is set to Accy instead of Norm. The true bandwidth, which determines the response to impulsive signals and noise-like signals, is not affected by the sweep rate.

PSA Series Core Spectrum Analyzer  
Frequency

Description	Specifications	Supplemental information
<p><b>EMI Resolution Bandwidths</b></p> <p>CISPR Family</p> <p>Available when the detector is Quasi-Peak, EMI Average or EMI Peak</p> <p>200 Hz, 9 kHz, 120 kHz</p> <p>1 MHz</p> <p>Non-CISPR bandwidths</p> <p>MIL STD family</p> <p>Available when the detector is MIL Peak</p> <p>10, 100 Hz, 1, 10, 100 kHz, 1 MHz</p> <p>Non-MIL STD bandwidths</p>	<p>Meets CISPR standard<sup>a</sup></p> <p>Meets CISPR standard<sup>a</sup></p> <p>1, 3, 10 sequence of –6 dB bandwidths</p> <p>–6 dB bandwidths meet MIL-STD-461D/E (20 Aug 1999)</p> <p>30, 300 Hz, 3 kHz, etc. sequence of –6 dB bandwidths</p>	<p>CISPR standard for these bandwidths is –6 dB widths, subject to masks</p> <p>CISPR standard is impulse bandwidth</p>

a. CISPR 16-1-1(2006)



Description	Specification	Supplemental information
<b>Analysis Bandwidth<sup>a</sup></b> <i>With Option 140</i> <i>With Option 122</i> <i>Option B7J</i>	40 MHz 80 MHz 10 MHz	

- a. Analysis bandwidth is the instantaneous bandwidth available about a center frequency over which the input signal can be digitized for further analysis or processing in the time, frequency, or modulation domain. The analysis bandwidth specifications shown here are with the options installed within the PSA. Additionally, the 321.4 MHz IF out, a standard feature for E4440A/43A/45A/46A/48A, provides down converted IF signal for an external digitizer to gain various analysis bandwidths. Refer to [“321.4 MHz IF Output” on page 107](#) for the nominal bandwidths of the output signal from the 321.4 MHz IF out under different conditions.

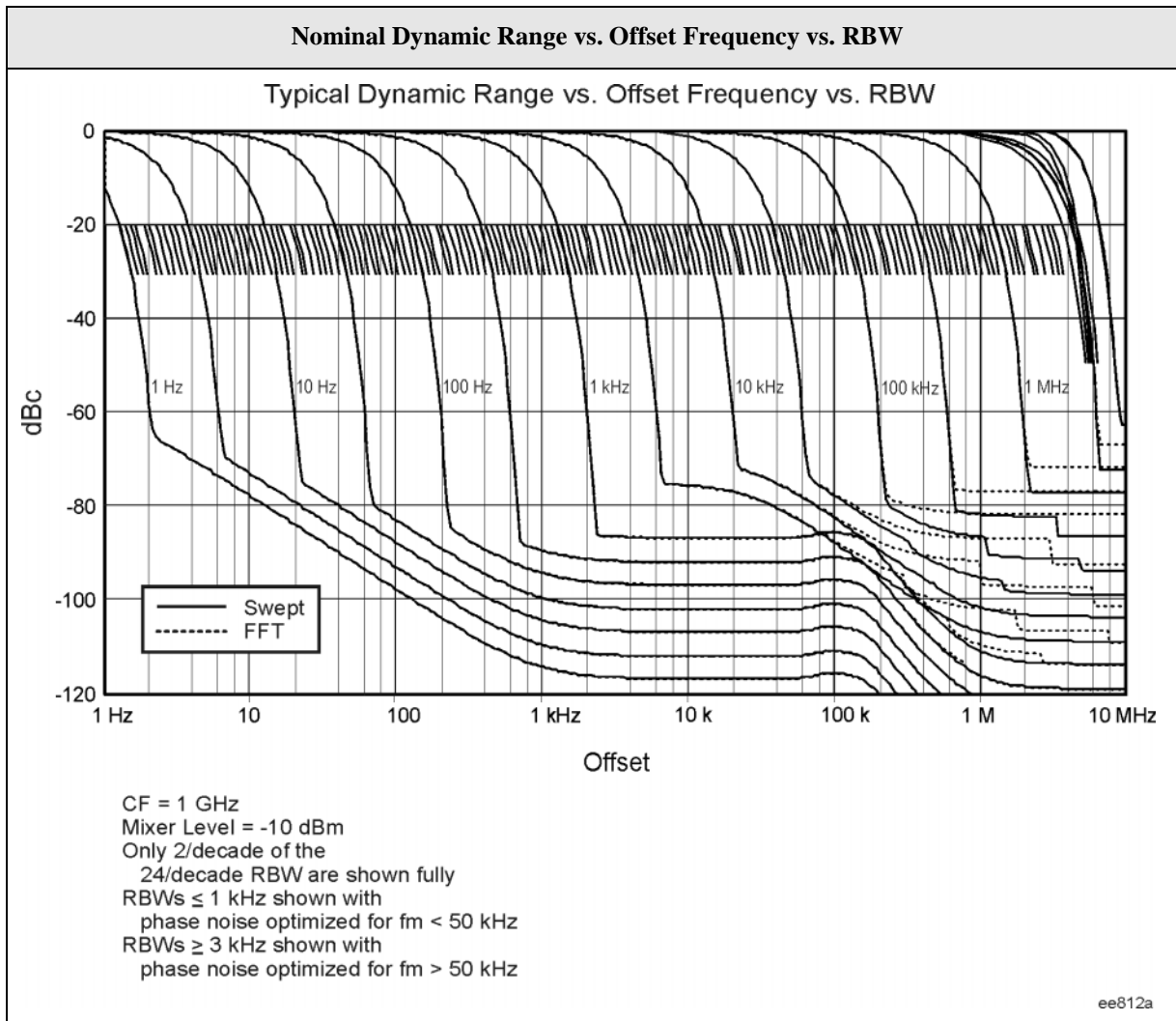

Description	Specifications	Supplemental Information
<b>Video Bandwidth (VBW)</b>		
Range	Same as Resolution Bandwidth range plus wide-open VBW (labeled 50 MHz)	
Accuracy		$\pm 6\%$ (nominal) in swept mode and zero span <sup>a</sup>

a. For FFT processing, the selected VBW is used to determine a number of averages for FFT results. That number is chosen to give roughly equivalent display smoothing to VBW filtering in a swept measurement. For example, if  $VBW = 0.1 \times RBW$ , four FFTs are averaged to generate one result.

Description	Specifications		Supplemental Information	
<b>Stability</b>				
Noise Sidebands Center Frequency = 1 GHz <sup>a</sup> Best-case Optimization <sup>b</sup>	20 to 30 °C	0 to 55 °C	Typical	Nominal
Newest Instruments <sup>c</sup> Offset				
100 Hz	-91 dBc/Hz	-90 dBc/Hz	-96 dBc/Hz	
1 kHz	-103 dBc/Hz	-100 dBc/Hz	-108 dBc/Hz	
10 kHz	-116 dBc/Hz	-115 dBc/Hz	-118 dBc/Hz	
30 kHz	-116 dBc/Hz	-115 dBc/Hz	-118 dBc/Hz	
100 kHz	-122 dBc/Hz	-121 dBc/Hz	-124 dBc/Hz	
1 MHz	-145 dBc/Hz <sup>d</sup>	-144 dBc/Hz <sup>d</sup>	-147 dBc/Hz <sup>e</sup>	-148 dBc/Hz <sup>e</sup>
6 MHz	-153 dBc/Hz <sup>d</sup>	-153 dBc/Hz <sup>d</sup>	-156 dBc/Hz <sup>e</sup>	-156.5 dBc/Hz <sup>e</sup>
10 MHz	-155 dBc/Hz <sup>d</sup>	-155 dBc/Hz <sup>d</sup>	-157.5 dBc/Hz <sup>e</sup>	-158 dBc/Hz <sup>e</sup>
Oldest Instruments Offset				
100 Hz	-91 dBc/Hz	-90 dBc/Hz	-97 dBc/Hz	
1 kHz	-103 dBc/Hz	-100 dBc/Hz	-107 dBc/Hz	
10 kHz	-114 dBc/Hz	-113 dBc/Hz	-117 dBc/Hz	
30 kHz	-114 dBc/Hz	-113 dBc/Hz	-117 dBc/Hz	
100 kHz	-120 dBc/Hz	-119 dBc/Hz	-123 dBc/Hz	
1 MHz	-144 dBc/Hz <sup>d</sup>	-142 dBc/Hz <sup>d</sup>	-146 dBc/Hz <sup>e</sup>	-148 dBc/Hz <sup>e</sup>
6 MHz	-151 dBc/Hz <sup>d</sup>	-150 dBc/Hz <sup>d</sup>	-152 dBc/Hz <sup>e</sup>	-156 dBc/Hz <sup>e</sup>
10 MHz	-151 dBc/Hz <sup>d</sup>	-150 dBc/Hz <sup>d</sup>	-152 dBc/Hz <sup>e</sup>	-157.5 dBc/Hz <sup>e</sup>
Residual FM			<(1 Hz × N <sup>f</sup> ) p-p in 1 s	

- a. Nominal changes of phase noise sidebands with other center frequencies are shown by some examples in the graphs that follow. To predict the phase noise for other center frequencies, note that phase noise at offsets above approximately 1 kHz increases nominally as  $20 \times \log N$ , where N is the harmonic mixer mode. For offsets below 1 kHz, and center frequencies above 1 GHz, the phase noise increases nominally as  $20 \times \log CF$ , where CF is the center frequency in GHz.
- b. Noise sidebands for offsets of 30 kHz and below are shown for phase noise optimization set to optimize  $\leq(f)$  for  $f < 50$  kHz; for offsets of 100 kHz and above, the optimization is set for  $f > 50$  kHz.

## PSA Series Core Spectrum Analyzer Frequency

- c. Instruments with serial numbers of MY44020000 or higher, or US44020000 or higher, or SG44020000 or higher are the newest instruments. Instruments with lower serial numbers are the older instruments. The transition between these occurred around January 2004. Press System, Show System to read out the serial number.
- d. Analyzer-contributed phase noise at the low levels of this offset requires advanced verification techniques because broadband noise would otherwise cause excessive measurement error. Agilent uses a high level low phase noise CW test signal and sets the input attenuator so that the mixer level will be well above the normal top-of-screen level (-10 dBm) but still well below the 1 dB compression level. This improves dynamic range (carrier to broadband noise ratio) at the expense of amplitude uncertainty due to compression of the phase noise sidebands of the analyzer. (If the mixer level were increased to the "1 dB Gain Compression Point," the compression of a single sideband is specified to be 1 dB or lower. At lower levels, the compression falls off rapidly. The compression of phase noise sidebands is substantially less than the compression of a single-sideband test signal, further reducing the uncertainty of this technique.) Agilent also measures the broadband noise of the analyzer without the CW signal and subtracts its power from the measured phase noise power. The same techniques of overdrive and noise subtraction can be used in measuring a DUT, of course.
- e. "Typical" results include the effect of the signal generator used in verifying performance; nominal results show performance observed during development with specialized signal sources.
- f. N is the harmonic mixing mode.

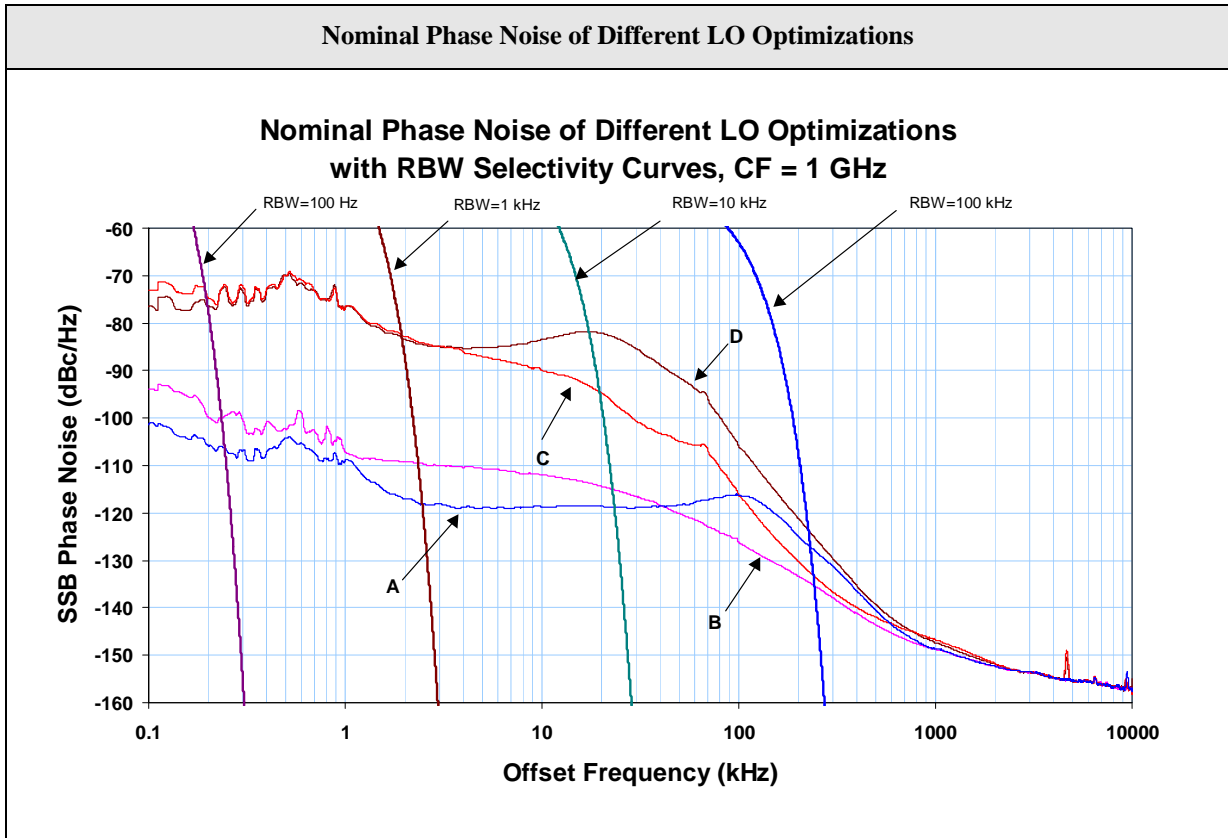

Sweep Type	Span	Optimize L (f) for f < 50 kHz	Optimize L (f) for f > 50 kHz	Optimize LO for fast tuning
FFT	All	<b>A</b> (Dual Loop Wideband)	<b>B</b> (Dual Loop Narrowband)	<b>D</b> (Single Loop Wideband)
Swept	< 2 MHz	<b>C</b> (Single Loop Narrowband)		
	2 to 50 MHz			
	> 50 MHz			

Nominal Phase Noise at Different Center Frequencies

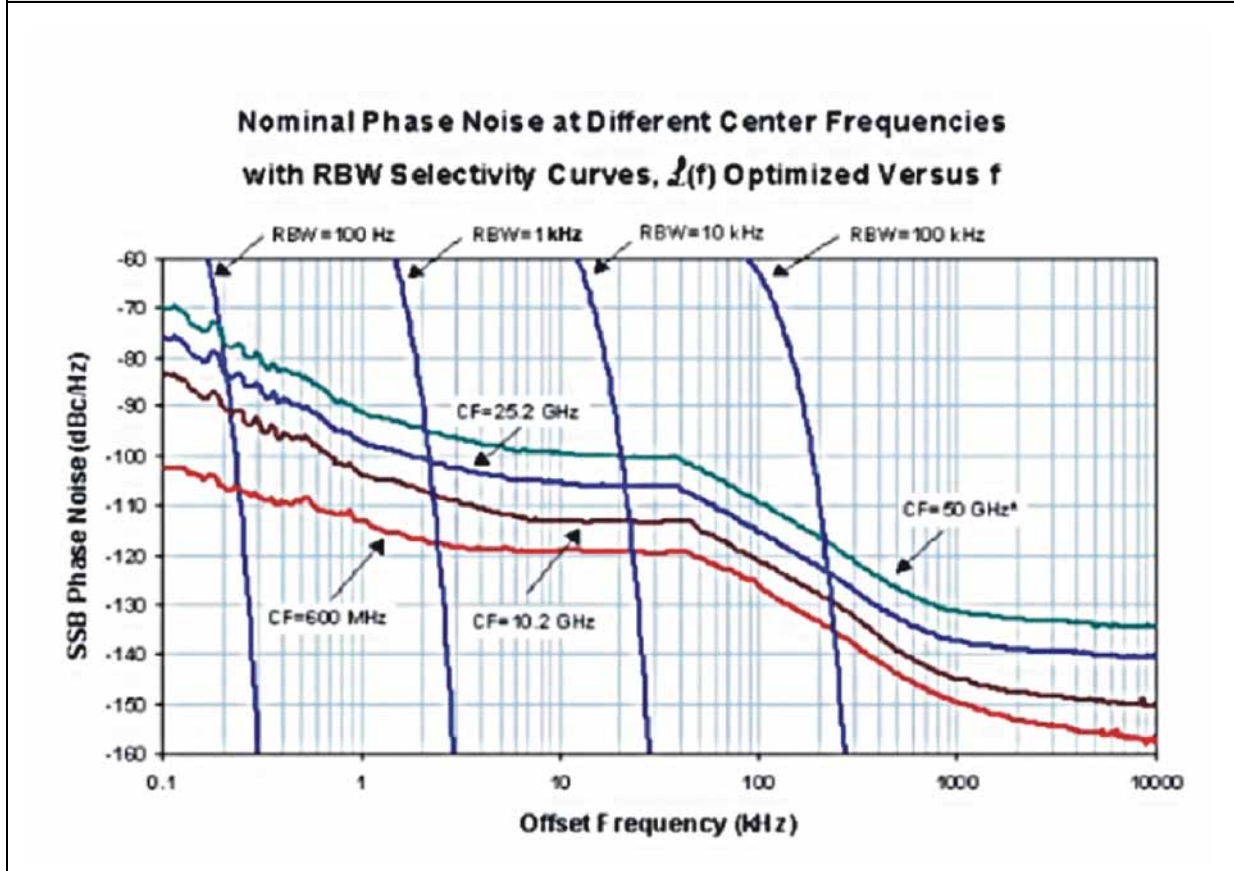

\*Unlike the other curves, which are measured results from the measurement of excellent sources, the CF = 50 GHz curve is the predicted, not observed, phase noise, computed from the 25.2 GHz observation. See the footnotes in the Frequency Stability section for the details of phase noise performance versus center frequency.

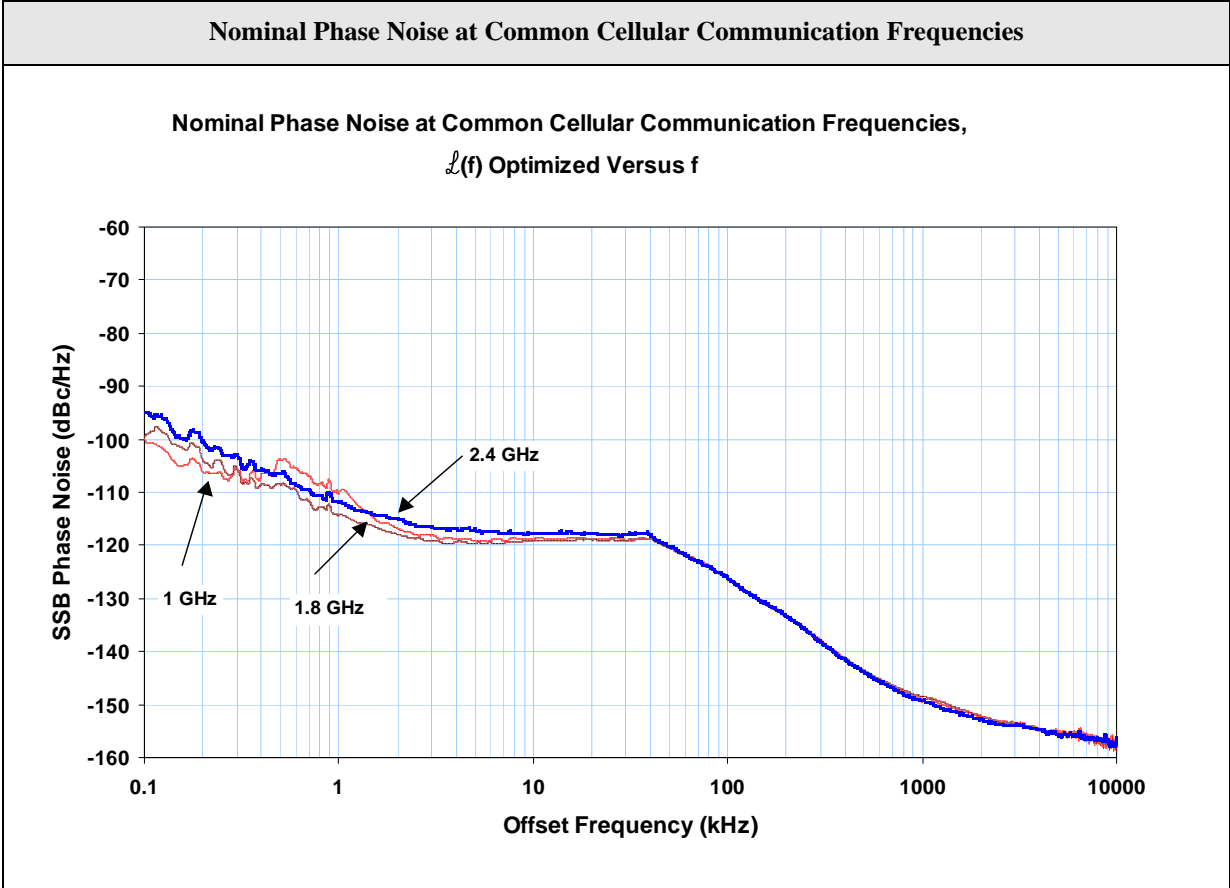

## Amplitude

Description	Specifications	Supplemental Information
<b>Measurement Range</b>		
Preamp installed or off:	Displayed Average Noise Level to +30 dBm	
Preamp On:		
Option 1DS	Displayed Average Noise Level to +30 dBm	
Option 110	Displayed Average Noise Level to +23 dBm	
Input Attenuation Range	0 to 70 dB, in 2 dB steps	

Description	Specifications	Supplemental Information
<b>Maximum Safe Input Level</b>		
Average Total Power	+30 dBm (1 W)	Preamp installed and off, or without preamp.
Applies with preamp ( <i>Option 1DS</i> )	+30 dBm (1 W)	
Applies with preamp ( <i>Option 110</i> )	+23 dBm	
Peak Pulse Power <10 $\mu$ s pulse width, <1% duty cycle, and input attenuation $\geq$ 30 dB	+50 dBm (100 W)	
DC volts		
DC Coupled	$\pm$ 0.2 Vdc	
AC Coupled (E4443A, E4445A, E4440A)	$\pm$ 100 Vdc	



## Gain Compression

E4443A, E4445A, E4440A

Description	Specifications	Supplemental Information
<b>1 dB Gain Compression Point (Two-tone)<sup>a b c</sup></b>	Maximum power at mixer <sup>d</sup>	Nominal <sup>e</sup>
20 to 200 MHz	0 dBm	+3 dBm
200 MHz to 3.0 GHz	+3 dBm	+7 dBm
3.0 to 6.6 GHz	+3 dBm	+4 dBm
6.6 to 26.5 GHz	-2 dBm	0 dBm

- a. Large signals, even at frequencies not shown on the screen, can cause the analyzer to mismeasure on-screen signals because of two-tone gain compression. This specification tells how large an interfering signal must be in order to cause a 1 dB change in an on-screen signal.
- b. Tone spacing > 15 times RBW, with a minimum of 30 kHz of separation
- c. Reference level and off-screen performance: The reference level (RL) behavior differs from previous analyzers in a way that makes PSA more flexible. In previous analyzers, the RL controlled how the measurement was performed as well as how it was displayed. Because the logarithmic amplifier in previous analyzers had both range and resolution limitations, this behavior was necessary for optimum measurement accuracy. The logarithmic amplifier in PSA, however, is implemented digitally such that the range and resolution greatly exceed other instrument limitations. Because of this, a PSA can make measurements largely independent of the setting of the RL without compromising accuracy. Because the RL becomes a display function, not a measurement function, a marker can read out results that are off-screen, either above or below, without any change in accuracy. The only exception to the independence of RL and the way in which the measurement is performed is in the input attenuation setting: When the input attenuation is set to auto, the rules for the determination of the input attenuation include dependence on the reference level. Because the input attenuation setting controls the trade off between large signal behaviors (third-order intermodulation, compression, and display scale fidelity) and small signal effects (noise), the measurement results can change with RL changes when the input attenuation is set to auto.
- d. Mixer power level (dBm) = input power (dBm) – input attenuation (dB).
- e. The compression of a small on-screen signal by a large interfering signal can be represented as a curve of compression versus the level of the interfering signal. The specified performance is a level/compression pair. The specification could be verified by finding the level for which the compression is 1 dB, or by finding the compression for the specified level. The latter technique is used. Therefore, the amount of compression is known in production, and the typical compression is known statistically, thus allowing a “typical” listing. The level required to reach 1 dB compression is not monitored in production, thus “nominal” performance is shown for this view of the performance.

Description	Specifications	Supplemental Information	
<p><b>Typical Gain Compression (Two-tone)</b></p> <p>20 to 200 MHz</p> <p>200 MHz to 6.6 GHz</p> <p>6.6 to 26.5 GHz</p> <p>Preamp On (<i>Option 1DS</i>) Maximum power at the preamp<sup>b</sup> for 1 dB gain compression</p> <p>10 to 200 MHz</p> <p>200 MHz to 3 GHz</p> <p>Preamp On (<i>Option 110</i>) Maximum power at the preamp<sup>b</sup> for 1 dB gain compression</p> <p>10 to 200 MHz</p> <p>200 MHz to 3.0 GHz</p> <p>3.0 to 6.6 GHz</p> <p>6.6 to 26.5 GHz</p>		<p>Mixer Level</p> <p>0 dBm</p> <p>+3 dBm</p> <p>-2 dBm</p> <p>-30 dBm (nominal)</p> <p>-25 dBm (nominal)</p> <p>-24 dBm (nominal)</p> <p>-20 dBm (nominal)</p> <p>-23 dBm (nominal)</p> <p>-27 dBm (nominal)</p>	<p>Typical<sup>a</sup> Compression</p> <p>&lt;0.5 dB</p> <p>&lt;0.5 dB</p> <p>&lt;0.4 dB</p>

- a. The compression of a small on-screen signal by a large interfering signal can be represented as a curve of compression versus the level of the interfering signal. The specified performance is a level/compression pair. The specification could be verified by finding the level for which the compression is 1 dB, or by finding the compression for the specified level. The latter technique is used. Therefore, the amount of compression is known in production, and the typical compression is known statistically, thus allowing a “typical” listing. The level required to reach 1 dB compression is not monitored in production, thus “nominal” performance is shown for this view of the performance.
- b. Total power at the preamp (dBm) = total power at the input (dBm) – input attenuation (dB).

E4447A, E4446A, E4448A

Description	Specifications	Supplemental Information
<b>1 dB Gain Compression Point (Two-tone)<sup>a b c</sup></b>	Maximum power at mixer <sup>d</sup>	Nominal <sup>e</sup>
20 to 200 MHz	+2 dBm	+3 dBm
200 MHz to 3.0 GHz	+3 dBm	+7 dBm
3.0 to 6.6 GHz	+3 dBm	+4 dBm
6.6 to 26.8 GHz	-2 dBm	0 dBm
26.8 to 50.0 GHz		0 dBm

- a. Large signals, even at frequencies not shown on the screen, can cause the analyzer to mismeasure on-screen signals because of two-tone gain compression. This specification tells how large an interfering signal must be in order to cause a 1 dB change in an on-screen signal.
- b. Tone spacing > 15 times RBW, with a minimum of 30 kHz of separation.
- c. Reference level and off-screen performance: The reference level (RL) behavior differs from previous analyzers in a way that makes PSA more flexible. In previous analyzers, the RL controlled how the measurement was performed as well as how it was displayed. Because the logarithmic amplifier in previous analyzers had both range and resolution limitations, this behavior was necessary for optimum measurement accuracy. The logarithmic amplifier in PSA, however, is implemented digitally such that the range and resolution greatly exceed other instrument limitations. Because of this, a PSA can make measurements largely independent of the setting of the RL without compromising accuracy. Because the RL becomes a display function, not a measurement function, a marker can read out results that are off-screen, either above or below, without any change in accuracy. The only exception to the independence of RL and the way in which the measurement is performed is in the input attenuation setting: When the input attenuation is set to auto, the rules for the determination of the input attenuation include dependence on the reference level. Because the input attenuation setting controls the trade off between large signal behaviors (third-order intermodulation, compression, and display scale fidelity) and small signal effects (noise), the measurement results can change with RL changes when the input attenuation is set to auto.
- d. Mixer power level (dBm) = input power (dBm) – input attenuation (dB).
- e. The compression of a small on-screen signal by a large interfering signal can be represented as a curve of compression versus the level of the interfering signal. The specified performance is a level/compression pair. The specification could be verified by finding the level for which the compression is 1 dB, or by finding the compression for the specified level. The latter technique is used. Therefore, the amount of compression is known in production, and the typical compression is known statistically, thus allowing a “typical” listing. The level required to reach 1 dB compression is not monitored in production, thus “nominal” performance is shown for this view of the performance.

Description	Specifications	Supplemental Information	
<p><b>Typical Gain Compression (Two-tone)</b></p> <p>20 to 200 MHz</p> <p>200 MHz to 6.6 GHz</p> <p>6.6 to 26.8 GHz</p> <p>Preamp On (<i>Option 1DS</i>) Maximum power at the preamp<sup>a</sup> for 1 dB gain compression</p> <p>10 to 200 MHz</p> <p>200 MHz to 3 GHz</p> <p>Preamp On (<i>Option 110</i>) Maximum power at the preamp<sup>a</sup> for 1 dB gain compression</p> <p>10 to 200 MHz</p> <p>200 MHz to 3.0 GHz</p> <p>3.0 to 6.6 GHz</p> <p>6.6 to 30 GHz</p> <p>30 GHz to 50 GHz</p>		<p>Mixer Level</p> <p>0 dBm</p> <p>+3 dBm</p> <p>-2 dBm</p> <p>-30 dBm (nominal)</p> <p>-25 dBm (nominal)</p> <p>-24 dBm (nominal)</p> <p>-20 dBm (nominal)</p> <p>-23 dBm (nominal)</p> <p>-27 dBm (nominal)</p> <p>-24 dBm (nominal)</p>	<p>Typical Compression</p> <p>&lt;0.5 dB</p> <p>&lt;0.5 dB</p> <p>&lt;0.4 dB</p>

a. Total power at the preamp (dBm) = total power at the input (dBm) – input attenuation (dB).

## Displayed Average Noise Level (DANL)

E4443A, E4445A, E4440A

Description	Specifications			Supplemental Information
<b>Displayed Average Noise Level (DANL)<sup>a</sup></b>	Input terminated, Sample or Average detector Averaging type = Log Normalized to 0 dB input attenuation			<b>Nominal</b>  -110 dBm -130 dBm
	3 Hz to 1 kHz			
1 to 10 kHz				
	<b>Zero span &amp; swept Normalized<sup>a</sup> to 1 Hz</b>	<b>FFT Only Actual<sup>b</sup> 1 Hz</b>		<b>Zero span &amp; swept<sup>a</sup> (typical)</b>
	<b>20 to 30 °C</b>	<b>0 to 55 °C</b>	<b>20 to 30 °C</b>	
10 to 100 kHz <sup>c</sup>	-137 dBm	-137 dBm	-137 dBm	-141 dBm
100 kHz to 1 MHz	-145 dBm	-145 dBm	-145 dBm	-149 dBm
1 to 10 MHz	-150 dBm	-150 dBm	-150 dBm	-153 dBm
10 MHz to 1.2 GHz	-154 dBm	-153 dBm	-154 dBm	-155 dBm
1.2 to 2.1 GHz	-153 dBm	-152 dBm	-153 dBm	-154 dBm
2.1 to 3 GHz	-152 dBm	-151 dBm	-152 dBm	-153 dBm
3 to 6.6 GHz	-152 dBm	-151 dBm	-151 dBm	-153 dBm
6.6 to 13.2 GHz	-150 dBm	-149 dBm	-149 dBm	-152 dBm
13.2 to 20 GHz	-147 dBm	-146 dBm	-146 dBm	-149 dBm
20 to 26.5 GHz	-143 dBm	-142 dBm	-143 dBm	-145 dBm

- a. DANL for zero span and swept is normalized in two ways and for two reasons. DANL is measured in a 1 kHz RBW and normalized to the narrowest available RBW, because the narrowest RBWs (1.0 to 1.8 Hz) are not usable for signals below -110 dBm but DANL can be a useful figure of merit for the other RBWs. (RBWs this small are usually best used in FFT mode, because sweep rates are very slow in these bandwidths. RBW autocoupling never selects these RBWs in swept mode because of potential errors at low signal levels.) The second normalization is that DANL is measured with 10 dB input attenuation and normalized to the 0 dB input attenuation case, because that makes DANL and third order intermodulation test conditions congruent, allowing accurate dynamic range estimation for the analyzer. Because of these normalizations, this measure of DANL is useful for estimating instrument performance such as TOI to noise range and compression to noise range, but not ultimate sensitivity.
- b. DANL for FFT measurements are useful for estimating the ultimate sensitivity of the analyzer for low-level signals. This specification is verified with 0 dB input attenuation and 1 Hz RBW. A limitation of this DANL specification is that some instruments have a center-screen-only spurious signal of nominally -150 dBm, which can be avoided by tuning the analyzer a few hertz away from the frequency of interest.

PSA Series Core Spectrum Analyzer  
Amplitude

- c. Specifications are shown for instruments with serial numbers of MY44020000 or higher, or US44020000 or higher, or SG44020000 or higher. For instruments with lower serial numbers, the specifications are -135 dBm and the typical is -142 dBm. The transition between these occurred around January 2004. Press System, Show System to read out the serial number.

Description	Specifications			Supplemental Information
<b>Displayed Average Noise Level (cont.)</b>  Preamp Off (Option 110 installed)  10 to 100 kHz <sup>c</sup> 100 kHz to 1 MHz 1 to 10 MHz 10 MHz to 1.2 GHz 1.2 to 2.1 GHz 2.1 to 3 GHz 3 to 6.6 GHz 6.6 to 13.2 GHz 13.2 to 16 GHz 16 to 19 GHz 19 to 26.5 GHz	<b>Zero span &amp; swept Normalized<sup>a</sup> to 1 Hz</b>		<b>FFT Only Actual<sup>b</sup> 1 Hz</b>	<b>Zero span &amp; swept<sup>a</sup> (typical)</b>
	<b>20 to 30 °C</b>	<b>0 to 55 °C</b>	<b>20 to 30 °C</b>	
	-137 dBm	-137 dBm	-137 dBm	-141 dBm
	-145 dBm	-145 dBm	-145 dBm	-149 dBm
	-150 dBm	-150 dBm	-150 dBm	-153 dBm
	-153 dBm	-152 dBm	-153 dBm	-155 dBm
	-152 dBm	-151 dBm	-152 dBm	-154 dBm
	-151 dBm	-150 dBm	-151 dBm	-153 dBm
	-151 dBm	-150 dBm	-151 dBm	-153 dBm
	-147 dBm	-146 dBm	-147 dBm	-150 dBm
	-144 dBm	-143 dBm	-144 dBm	-147 dBm
	-144 dBm	-143 dBm	-144 dBm	-148 dBm
-140 dBm	-139 dBm	-140 dBm	-144 dBm	

- a. DANL for zero span and swept is normalized in two ways and for two reasons. DANL is measured in a 1 kHz RBW and normalized to the narrowest available RBW, because the narrowest RBWs (1.0 to 1.8 Hz) are not usable for signals below -110 dBm but DANL can be a useful figure of merit for the other RBWs. (RBWs this small are usually best used in FFT mode, because sweep rates are very slow in these bandwidths. RBW autocoupling never selects these RBWs in swept mode because of potential errors at low signal levels.) The second normalization is that DANL is measured with 10 dB input attenuation and normalized to the 0 dB input attenuation case, because that makes DANL and third order intermodulation test conditions congruent, allowing accurate dynamic range estimation for the analyzer. Because of these normalizations, this measure of DANL is useful for estimating instrument performance such as TOI to noise range and compression to noise range, but not ultimate sensitivity.
- b. DANL for FFT measurements are useful for estimating the ultimate sensitivity of the analyzer for low-level signals. This specification is verified with 0 dB input attenuation and 1 Hz RBW. A limitation of this DANL specification is that some instruments have a center-screen-only spurious signal of nominally -150 dBm, which can be avoided by tuning the analyzer a few hertz away from the frequency of interest.

- c. Specifications are shown for instruments with serial numbers of MY44020000 or higher, or US44020000 or higher, or SG44020000 or higher. For instruments with lower serial numbers, the specifications are  $-135$  dBm and the typical is  $-142$  dBm. The transition between these occurred around January 2004. Press System, Show System to read out the serial number.

Description	Specifications			Supplemental Information
<b>Displayed Average Noise Level (cont.)</b>	<b>Zero span &amp; swept</b>		<b>FFT Only</b>	<b>Zero span &amp; swept<sup>a</sup></b>  <b>(typical)</b>
	<b>Normalized<sup>a</sup> to 1 Hz</b>		<b>Actual<sup>b</sup> 1 Hz</b>	
	<b>20 to 30 °C</b>	<b>0 to 55 °C</b>	<b>20 to 30 °C</b>	
Preamp On (Option 1DS installed)				
100 to 200 kHz	-159 dBm	-157 dBm	-158 dBm	-162 dBm
200 kHz to 500 kHz	-159 dBm	-157 dBm	-158 dBm	-162 dBm
500 kHz to 1 MHz	-163 dBm	-160 dBm	-162 dBm	-165 dBm
1 MHz to 10 MHz	-166 dBm	-163 dBm	-165 dBm	-168 dBm
10 to 500 MHz	-169 dBm	-168 dBm	-168 dBm	-170 dBm
500 MHz to 1.0 GHz	-168 dBm	-167 dBm	-167 dBm	-169 dBm
1.1 to 2.1 GHz	-167 dBm	-166 dBm	-166 dBm	-168 dBm
2.1 to 3.0 GHz	-165 dBm	-165 dBm	-165 dBm	-166 dBm
Preamp On (Option 110 installed)				
10 to 50 MHz	-148 dBm	-147 dBm	-148 dBm	-154 dBm
50 kHz to 500 MHz	-153 dBm	-152 dBm	-153 dBm	-164 dBm
500 MHz to 2.1 GHz	-166 dBm	-165 dBm	-166 dBm	-168 dBm
2.1 GHz to 3 GHz	-166 dBm	-165 dBm	-166 dBm	-168 dBm
3 to 6.6 GHz	-165 dBm	-164 dBm	-165 dBm	-166 dBm
6.6 to 13.2 GHz	-163 dBm	-162 dBm	-163 dBm	-165 dBm
13.2 to 16 GHz	-162 dBm	-161 dBm	-162 dBm	-165 dBm
16 to 19 GHz	-162 dBm	-159 dBm	-162 dBm	-164 dBm
19 to 26.5 GHz	-159 dBm	-156 dBm	-159 dBm	-161 dBm

a. DANL for zero span and swept is normalized in two ways and for two reasons. DANL is measured in a 1 kHz RBW and normalized to the narrowest available RBW, because the narrowest RBWs (1.0 to 1.8 Hz) are not usable for signals below -110 dBm but DANL can be a useful figure of merit for the other RBWs. (RBWs this small are usually best used in FFT mode, because sweep rates are very slow in these bandwidths. RBW autocoupling never selects these RBWs in swept mode because of potential errors at low signal levels.) The second normalization is that DANL is measured with 10 dB input attenuation and normalized to the 0 dB input attenuation case, because that makes DANL and third order intermodulation test conditions congruent, allowing accurate dynamic range estimation for the analyzer. Because of these normalizations, this measure of DANL is useful for estimating instrument performance such as TOI to noise range and compression to noise range, but not ultimate sensitivity.



- b. DANL for FFT measurements are useful for estimating the ultimate sensitivity of the analyzer for low-level signals. This specification is verified with 0 dB input attenuation and 1 Hz RBW. A limitation of this DANL specification is that some instruments have a center-screen-only spurious signal of nominally  $-150$  dBm, which can be avoided by tuning the analyzer a few hertz away from the frequency of interest.

E4447A, E4446A, E4448A

Description	Specifications				Supplemental Information
<b>Displayed Average Noise Level (DANL)<sup>a</sup></b>	Input terminated, Sample or Average detector Averaging type = Log Normalized to 0 dB input attenuation				<b>Nominal</b>
	3 Hz to 1 kHz				-110 dBm
1 to 10 kHz					-130 dBm
	<b>Zero span &amp; swept Normalized<sup>a</sup> to 1 Hz</b>		<b>FFT Only Actual<sup>b</sup> 1 Hz</b>		<b>Zero span &amp; swept (typical)</b>
	<b>20 to 30 °C</b>	<b>0 to 55 °C</b>	<b>20 to 30 °C</b>	<b>0 to 55 °C</b>	
10 to 100 kHz <sup>c</sup>	-137 dBm	-137 dBm	-137 dBm	-137 dBm	-141 dBm
100 kHz to 1 MHz	-145 dBm	-145 dBm	-145 dBm	-145 dBm	-150 dBm
1 to 10 MHz	-150 dBm	-150 dBm	-150 dBm	-150 dBm	-155 dBm
10 MHz to 1.2 GHz	-153 dBm	-152 dBm	-152 dBm	-151 dBm	-154 dBm
1.2 to 2.1 GHz	-152 dBm	-151 dBm	-151 dBm	-150 dBm	-153 dBm
2.1 to 3 GHz	-151 dBm	-149 dBm	-150 dBm	-148 dBm	-152 dBm
3 to 6.6 GHz	-151 dBm	-149 dBm	-150 dBm	-149 dBm	-152 dBm
6.6 to 13.2 GHz	-146 dBm	-145 dBm	-146 dBm	-145 dBm	-149 dBm
13.2 to 20 GHz	-144 dBm	-142 dBm	-143 dBm	-141 dBm	-146 dBm
20 to 22.5 GHz	-143 dBm	-141 dBm	-143 dBm	-141 dBm	-146 dBm
22.5 to 26.8 GHz	-140 dBm	-138 dBm	-140 dBm	-138 dBm	-144 dBm
26.8 to 31.15 GHz	-142 dBm	-140 dBm	-141 dBm	-139 dBm	-145 dBm
31.15 to 35 GHz	-134 dBm	-132 dBm	-133 dBm	-131 dBm	-136 dBm
35 to 38 GHz	-129 dBm	-127 dBm	-129 dBm	-127 dBm	-132 dBm
38 to 44 GHz	-131 dBm	-129 dBm	-131 dBm	-128 dBm	-134 dBm
44 to 49 GHz	-128 dBm	-127 dBm	-127 dBm	-126 dBm	-131 dBm
49 to 50 GHz	-127 dBm	-126 dBm	-126 dBm	-125 dBm	-130 dBm

- a. DANL for zero span and swept is normalized in two ways and for two reasons. DANL is measured in a 1 kHz RBW and normalized to the narrowest available RBW, because the narrowest RBWs (1.0 to 1.8) are not usable for signals below  $-110$  dBm but DANL can be a useful figure of merit for the other RBWs. (RBWs this small are usually best used in FFT mode, because sweep rates are very slow in these bandwidths. RBW autocoupling never selects these RBWs in swept mode because of potential errors at low signal levels.) The second normalization is that DANL is measured with 10 dB input attenuation and normalized to the 0 dB input attenuation case, because that makes DANL and third order intermodulation test conditions congruent, allowing accurate dynamic range estimation for the analyzer. Because of these normalizations, this measure of DANL is useful for estimating instrument performance such as TOI to noise range and compression to noise range, but not ultimate sensitivity.
- b. DANL for FFT measurements are useful for estimating the ultimate sensitivity of the analyzer for low-level signals. This specification is verified with 0 dB input attenuation and 1 Hz RBW. A limitation of this DANL specification is that some instruments have a center-screen-only spurious signal of nominally  $-150$  dBm, which can be avoided by tuning the analyzer a few hertz away from the frequency of interest.
- c. Specifications are shown for instruments with serial numbers of MY44020000 or higher, or US44020000 or higher, or SG44020000 or higher. For instruments with lower serial numbers, the specifications are  $-140$  dBm and the typical is  $-143$  dBm. The transition between these occurred around January 2004. Press System, Show System to read out the serial number.

Description	Specifications				Supplemental Information
<b>Displayed Average Noise Level (cont.)</b>	<b>Zero span &amp; swept Normalized<sup>a</sup> to 1 Hz</b>		<b>FFT Only Actual<sup>a</sup> 1 Hz</b>		<b>Zero span &amp; swept</b>
Preselected Path <sup>b</sup>	<b>20 to 30 °C</b>	<b>0 to 55 °C</b>	<b>20 to 30 °C</b>	<b>0 to 55 °C</b>	<b>(typical)</b>
Preamp Off (Option 110 or 123 installed)					
10 to 100 kHz	-137 dBm	-137 dBm	-137 dBm	-137 dBm	-141 dBm
100 kHz to 1 MHz	-145 dBm	-145 dBm	-145 dBm	-145 dBm	-150 dBm
1 to 10 MHz	-150 dBm	-150 dBm	-150 dBm	-150 dBm	-155 dBm
10 MHz to 1.2 GHz	-152 dBm	-151 dBm	-152 dBm	-151 dBm	-154 dBm
1.2 to 2.1 GHz	-150 dBm	-149 dBm	-150 dBm	-149 dBm	-153 dBm
2.1 to 3 GHz	-149 dBm	-147 dBm	-149 dBm	-147 dBm	-152 dBm
3 to 6.6 GHz	-150 dBm	-149 dBm	-150 dBm	-149 dBm	-152 dBm
6.6 to 13.2 GHz	-144 dBm	-143 dBm	-144 dBm	-143 dBm	-145 dBm
13.2 to 19 GHz	-141 dBm	-139 dBm	-141 dBm	-139 dBm	-144 dBm
19 to 22.5 GHz	-141 dBm	-139 dBm	-141 dBm	-139 dBm	-144 dBm
22.5 to 26.8 GHz	-136 dBm	-135 dBm	-136 dBm	-135 dBm	-140 dBm
26.8 to 31.15 GHz	-139 dBm	-137 dBm	-139 dBm	-137 dBm	-142 dBm
31.15 to 35 GHz	-131 dBm	-129 dBm	-131 dBm	-129 dBm	-132 dBm
35 to 38 GHz	-125 dBm	-123 dBm	-125 dBm	-123 dBm	-127 dBm
38 to 41 GHz	-127 dBm	-125 dBm	-127 dBm	-125 dBm	-128 dBm
41 to 44 GHz	-127 dBm	-125 dBm	-127 dBm	-125 dBm	-128 dBm
44 to 45 GHz	-124 dBm	-122 dBm	-124 dBm	-122 dBm	-128 dBm
45 to 49 GHz	-124 dBm	-122 dBm	-124 dBm	-122 dBm	-125 dBm
49 to 50 GHz	-124 dBm	-122 dBm	-124 dBm	-122 dBm	-125 dBm

a. DANL for FFT measurements are useful for estimating the ultimate sensitivity of the analyzer for low-level signals. This specification is verified with 0 dB input attenuation and 1 Hz RBW. A limitation of this DANL specification is that some instruments have a center-screen-only spurious signal of nominally -150 dBm, which can be avoided by tuning the analyzer a few hertz away from the frequency of interest.

b. For unpreselected path performance, refer to chapter 20.

Description	Specifications				Supplemental Information
<b>Displayed Average Noise Level (cont.)</b>  Preamp On <i>(Option 1DS)</i>  100 to 200 kHz  200 to 500 kHz  500 kHz to 1 MHz  1 to 10 MHz  10 to 500 MHz  0.5 to 1.2 GHz  1.2 to 2.1 GHz  2.1 to 3.0 GHz	<b>Zero span &amp; swept Normalized <sup>a</sup> to 1 Hz</b>		<b>FFT Only Actual<sup>a</sup> 1 Hz</b>		<b>Zero span &amp; swept</b>
	20 to 30 °C	0 to 55 °C	20 to 30 °C	0 to 55 °C	(typical)
	-158 dBm	-157 dBm	-157 dBm	-155 dBm	-162 dBm
	-158 dBm	-157 dBm	-157 dBm	-155 dBm	-162 dBm
	-161 dBm	-160 dBm	-160 dBm	-158 dBm	-165 dBm
	-167 dBm	-166 dBm	-166 dBm	-166 dBm	-169 dBm
	-167 dBm	-166 dBm	-167 dBm	-167 dBm	-169 dBm
	-166 dBm	-165 dBm	-166 dBm	-166 dBm	-168 dBm
	-165 dBm	-164 dBm	-165 dBm	-165 dBm	-167 dBm
-163 dBm	-162 dBm	-163 dBm	-162 dBm	-165 dBm	

a. DANL for FFT measurements are useful for estimating the ultimate sensitivity of the analyzer for low-level signals. This specification is verified with 0 dB input attenuation and 1 Hz RBW. A limitation of this DANL specification is that some instruments have a center-screen-only spurious signal of nominally -150 dBm, which can be avoided by tuning the analyzer a few hertz away from the frequency of interest.

PSA Series Core Spectrum Analyzer  
Amplitude

Description	Specifications				Supplemental Information
	Zero span & swept Normalized <sup>a</sup> to 1 Hz		FFT Only Actual <sup>a</sup> 1 Hz		
	20 to 30 °C	0 to 55 °C	20 to 30 °C	0 to 55 °C	Zero span & swept (typical)
Preamp On (Option 110)					
10 to 50 MHz	-148 dBm	-147 dBm	-148 dBm	-147 dBm	-158 dBm
50 to 500 MHz	-153 dBm	-152 dBm	-153 dBm	-152 dBm	-164 dBm
500 MHz to 1.2 GHz	-165 dBm	-164 dBm	-165 dBm	-164 dBm	-168 dBm
1.2 to 2.1 GHz	-165 dBm	-164 dBm	-165 dBm	-164 dBm	-168 dBm
2.1 to 3 GHz	-165 dBm	-164 dBm	-165 dBm	-164 dBm	-167 dBm
3 to 6.6 GHz	-165 dBm	-164 dBm	-165 dBm	-164 dBm	-167 dBm
6.6 to 13.2 GHz	-162 dBm	-161 dBm	-162 dBm	-161 dBm	-165 dBm
13.2 to 19 GHz	-161 dBm	-160 dBm	-161 dBm	-160 dBm	-163 dBm
19 to 22.5 GHz	-161 dBm	-160 dBm	-161 dBm	-160 dBm	-162 dBm
22.5 to 26.8 GHz	-155 dBm	-154 dBm	-155 dBm	-154 dBm	-160 dBm
26.8 to 31.15 GHz	-157 dBm	-155 dBm	-157 dBm	-155 dBm	-161 dBm
31.15 to 35 GHz	-152 dBm	-149 dBm	-152 dBm	-149 dBm	-156 dBm
35 to 38 GHz	-146 dBm	-143 dBm	-146 dBm	-143 dBm	-150 dBm
38 to 41 GHz	-146 dBm	-143 dBm	-146 dBm	-143 dBm	-150 dBm
41 to 44 GHz	-146 dBm	-143 dBm	-146 dBm	-143 dBm	-150 dBm
44 to 45 GHz	-143 dBm	-139 dBm	-143 dBm	-139 dBm	-150 dBm
45 to 49 GHz	-143 dBm	-139 dBm	-143 dBm	-139 dBm	-146 dBm
49 to 50 GHz	-140 dBm	-136 dBm	-140 dBm	-136 dBm	-145 dBm

a. DANL for FFT measurements are useful for estimating the ultimate sensitivity of the analyzer for low-level signals. This specification is verified with 0 dB input attenuation and 1 Hz RBW. A limitation of this DANL specification is that some instruments have a center-screen-only spurious signal of nominally -150 dBm, which can be avoided by tuning the analyzer a few hertz away from the frequency of interest.

Description	Specifications	Supplemental Information
<b>Display Range</b>		
Log Scale	Ten divisions displayed; 0.1 to 1.0 dB/division in 0.1 dB steps, and 1 to 20 dB/division in 1 dB steps	
Linear Scale	Ten divisions	
<b>Marker Readout<sup>a</sup></b>		
Log units resolution		
Average Off, on-screen	0.01 dB	
Average On or remote	0.001 dB	
Linear units resolution		≤1 % of signal level

- a. Reference level and off-screen performance: The reference level (RL) behavior differs from previous analyzers in a way that makes PSA more flexible. In previous analyzers, the RL controlled how the measurement was performed as well as how it was displayed. Because the logarithmic amplifier in previous analyzers had both range and resolution limitations, this behavior was necessary for optimum measurement accuracy. The logarithmic amplifier in PSA, however, is implemented digitally such that the range and resolution greatly exceed other instrument limitations. Because of this, a PSA can make measurements largely independent of the setting of the RL without compromising accuracy. Because the RL becomes a display function, not a measurement function, a marker can read out results that are off-screen, either above or below, without any change in accuracy. The only exception to the independence of RL and the way in which the measurement is performed is in the input attenuation setting: When the input attenuation is set to auto, the rules for the determination of the input attenuation include dependence on the reference level. Because the input attenuation setting controls the trade off between large signal behaviors (third-order intermodulation, compression, and display scale fidelity) and small signal effects (noise), the measurement results can change with RL changes when the input attenuation is set to auto.

## Frequency Response

E4443A, E4445A, E4440A

Description	Specifications		Supplemental Information
<b>Frequency Response</b>			Refer to footnote for modes above 18 GHz <sup>a</sup>
10 dB input attenuation			
Maximum error relative to reference condition (50 MHz) <sup>b</sup>	<b>20 to 30 °C</b>	<b>0 to 55 °C</b>	<b>Typical 20 to 30 °C</b> (at worst observed frequency)
3 Hz to 3.0 GHz	±0.38 dB	±0.58 dB	±0.11 dB
3.0 to 6.6 GHz <sup>c</sup>	±1.50 dB	±2.00 dB	±0.6 dB
6.6 to 13.2 GHz <sup>c</sup>	±2.00 dB	±2.50 dB	±1.0 dB
13.2 to 22.0 GHz <sup>c</sup>	±2.00 dB	±2.50 dB	±0.9 dB
22.0 to 26.5 GHz <sup>c</sup>	±2.50 dB	±3.50 dB	±1.3 dB
Additional frequency response error, FFT mode <sup>d e</sup>	± [0.15 dB + (0.1 dB/MHz × FFT width <sup>f</sup> )] to a max. of ±0.40 dB		
Preamp On ( <i>Option 1DS</i> ), 100 kHz to 3.0 GHz	±0.70 dB	±0.80 dB	±0.20 dB (nominal)
Preamp On ( <i>Option 110</i> ) 10 MHz to 3.0 GHz			±0.20 dB (nominal)

- a. Signal frequencies above 18 GHz are prone to response errors due to modes in the Type-N connector used. With the use of Type-N to APC 3.5 mm adapter part number 1250-1744, there are nominally six such modes. These modes cause nominally up to a –0.35 dB amplitude change. The effect of these modes with this connector is included with these specifications.
- b. Specifications for frequencies > 3 GHz apply for sweep rates < 100 MHz/ms.
- c. Preselector centering applied.
- d. FFT frequency response errors are specified relative to swept measurements.
- e. This error need not be included in Absolute Amplitude Accuracy error budgets when the difference between the analyzer center frequency and the signal frequency is within ±1.5 % of the span.
- f. An FFT width is given by the span divided by the FFTs/Span parameter.



Description	Specifications		Supplemental Information
<b>Frequency Response at Attenuation <math>\neq</math> 10 dB</b>			
Atten = 20, 30 or 40 dB	<b>20 to 30 °C</b>	<b>0 to 55 °C</b>	
10 MHz to 2.2 GHz	$\pm 0.53$ dB	$\pm 0.68$ dB	
2.2 to 3 GHz	$\pm 0.69$ dB	$\pm 0.84$ dB	
Atten = 0 dB			
Preamp On ( <i>Option 1DS</i> )	$\pm 0.70$ dB	$\pm 0.80$ dB	
Preamp On ( <i>Option 110</i> )			
10 MHz to 3.05 GHz	$\pm 1.0$ dB	$\pm 1.9$ dB	$\pm 0.35$ dB
3.0 to 6.6 GHz	$\pm 1.75$ dB	$\pm 2.5$ dB	$\pm 0.8$ dB
6.6 to 13.2 GHz	$\pm 3.0$ dB	$\pm 3.5$ dB	$\pm 1.0$ dB
13.2 to 19 GHz	$\pm 3.0$ dB	$\pm 3.5$ dB	$\pm 1.2$ dB
19 to 26.5 GHz	$\pm 4.0$ dB	$\pm 4.5$ dB	$\pm 2.0$ dB
Other attenuator settings			Nominally, same performance as the 20, 30 and 40 dB settings

E4447A, E4446A, E4448A

Description	Specifications		Supplemental Information
<b>Frequency Response</b>			Refer to footnote for modes above 18 GHz <sup>a</sup>
10 dB input attenuation			
Maximum error relative to reference condition (50 MHz) <sup>b</sup>	<b>20 to 30 °C</b>	<b>0 to 55 °C</b>	<b>Typical</b> (at worst observed frequency)
3 Hz to 3.0 GHz	±0.38 dB	±0.70 dB	±0.15 dB
3.0 to 6.6 GHz <sup>c</sup>	±1.50 dB	±2.00 dB	±0.6 dB
6.6 to 13.2 GHz <sup>c</sup>	±2.00 dB	±3.00 dB	±1.0 dB
13.2 to 22.0 GHz <sup>c</sup>	±2.00 dB	±2.50 dB	±1.2 dB
22.0 to 26.8 GHz <sup>c</sup>	±2.50 dB	±3.50 dB	±1.3 dB
26.8 to 31.15 GHz <sup>c</sup>	±1.75 dB	±2.75 dB	±0.6 dB
31.15 to 50.0 GHz <sup>c</sup>	±2.50 dB	±3.50 dB	±1.0 dB
Additional frequency response error, FFT mode <sup>d e</sup>	±[0.15 dB + (0.1 dB/MHz × FFT width <sup>f</sup> )] to a max. of ±0.40 dB		
Preamp On ( <i>Option IDS</i> ), 100 kHz to 3.0 GHz	±0.70 dB	±0.80 dB	±0.20 dB (nominal)
Preamp On ( <i>Option I10</i> ) 10 MHz to 3 GHz			±0.30 dB (nominal)

- Signal frequencies above 18 GHz are prone to response errors due to modes in the Type-N connector used. With the use of Type-N to APC 3.5 mm adapter part number 1250-1744, there are nominally six such modes. These modes cause nominally up to a -0.35 dB amplitude change. The effect of these modes with this connector are included with these specifications.
- Specifications for frequencies > 3 GHz apply for sweep rates <100 MHz/ms.
- Preselector centering applied.
- FFT frequency response errors are specified relative to swept measurements.
- This error need not be included in Absolute Amplitude Accuracy error budgets when the difference between the analyzer center frequency and the signal frequency is within ±1.5 % of the span.
- An FFT width is given by the span divided by the FFTs/Span parameter.

Description	Specifications		Supplemental Information
<b>Frequency Response at Attenuation <math>\neq</math> 10 dB</b>			
Atten = 20, 30 or 40 dB	<b>20 to 30 °C</b>	<b>0 to 55 °C</b>	
10 MHz to 2.2 GHz	$\pm 0.53$ dB	$\pm 0.68$ dB	
2.2 to 3 GHz	$\pm 0.69$ dB	$\pm 0.84$ dB	
Atten = 0 dB			
Preamp On ( <i>Option 1DS</i> )	$\pm 0.70$ dB	$\pm 0.80$ dB	
Preamp On ( <i>Option 110</i> )			
10 MHz to 3.05 GHz	$\pm 1.3$ dB	$\pm 2.0$ dB	$\pm 0.5$ dB
3.0 to 6.6 GHz	$\pm 2.5$ dB	$\pm 3.0$ dB	$\pm 1.0$ dB
6.6 to 13.2 GHz	$\pm 2.5$ dB	$\pm 3.5$ dB	$\pm 1.2$ dB
13.2 to 19 GHz	$\pm 3.0$ dB	$\pm 4.0$ dB	$\pm 1.5$ dB
19 to 26.5 GHz	$\pm 4.0$ dB	$\pm 4.5$ dB	$\pm 2.0$ dB
26.5 to 31.15 GHz	$\pm 3.0$ dB	$\pm 3.5$ dB	$\pm 1.2$ dB
31.15 to 50 GHz	$\pm 3.5$ dB	$\pm 4.5$ dB	$\pm 1.6$ dB
Other attenuator settings			Nominally, same performance as the 20, 30 and 40 dB settings

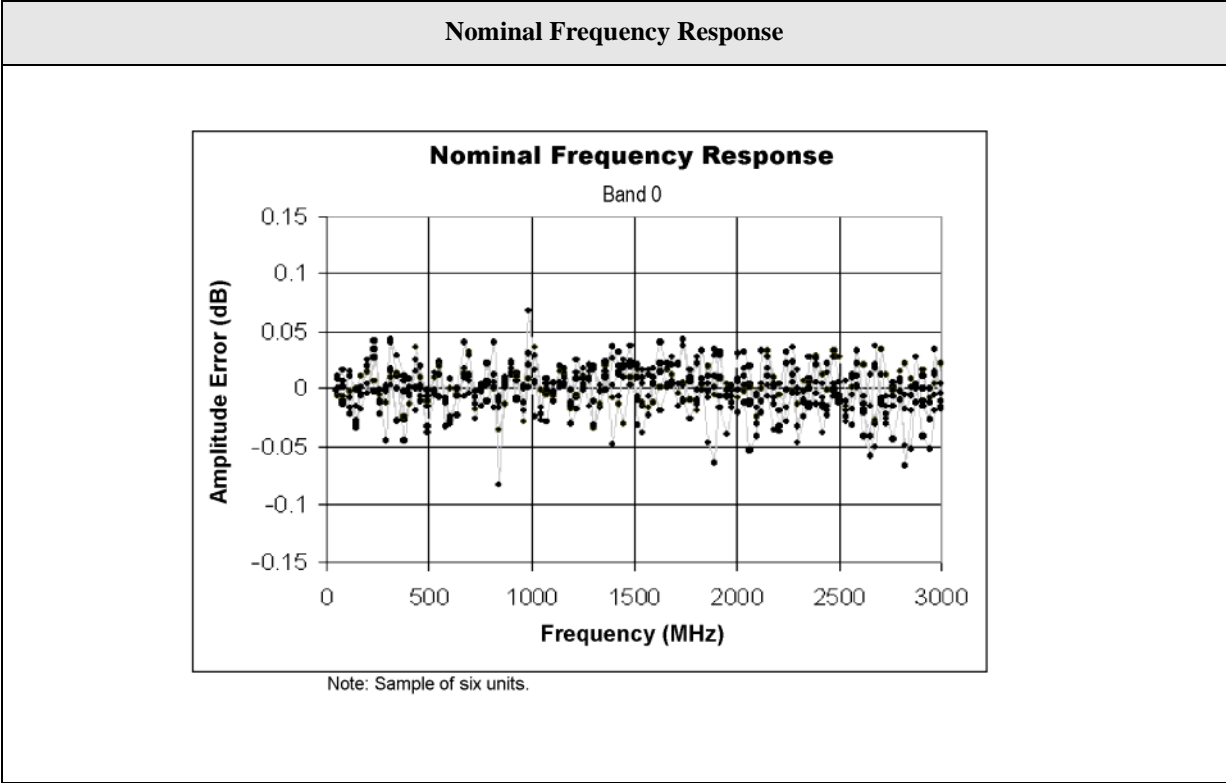



**E4443A, E4445A, E4440A**

Description	Specifications	Supplemental Information
<p><b>Preamp (Option 110)<sup>a</sup></b></p> <p>Gain</p> <p>10 MHz to 26.5 GHz</p> <p>Noise figure</p> <p>10 MHz to 30 MHz</p> <p>30 MHz to 3 GHz</p> <p>3 to 26.5 GHz</p>		<p>27 dB (nominal)</p> <p>12.5 dB (nominal)</p> <p>7.8 dB (nominal)</p> <p>10.3 dB (nominal)</p>

a. The preamp follows the input attenuator and AC/DC coupling control. It precedes the input mixer.

**E4447A, E4446A, E4448A**

Description	Specifications	Supplemental Information
<p><b>Preamp (Option 110)<sup>a</sup></b></p> <p>Gain</p> <p>10 MHz to 3.0 GHz</p> <p>3.0 to 30.0 GHz</p> <p>30.0 to 50.0 GHz</p> <p>Noise figure</p> <p>10 MHz to 30 MHz</p> <p>30 MHz to 3 GHz</p> <p>3 to 30 GHz</p> <p>30 to 50 GHz</p>		<p>28 dB (nominal)</p> <p>27 dB (nominal)</p> <p>24 dB (nominal)</p> <p>12.5 dB (nominal)</p> <p>7.8 dB (nominal)</p> <p>10.3 dB (nominal)</p> <p>21.8 dB (nominal)</p>

a. The preamp follows the input attenuator and AC/DC coupling control. It precedes the input mixer.

Description	Specifications	Supplemental Information
<b>Absolute Amplitude Accuracy</b>		
At 50 MHz <sup>a</sup> 20 to 30 °C 0 to 55 °C	±0.24 dB ±0.28 dB	±0.06 dB (typical)
At all frequencies <sup>a</sup> 20 to 30 °C	±(0.24 dB + frequency response)	±(0.06 dB + frequency response) (typical)
0 to 55 °C	±(0.28 dB + frequency response)	
<b>95 % Confidence Absolute Amplitude Accuracy<sup>b</sup></b>		
Wide range of signal levels, RBWs, RLs, etc.		
0 to 3 GHz, Atten = 10 dB		±0.19 dB
0 to 2.2 GHz, Atten = 10, 20, 30 or 40 dB		±0.20 dB
<b>Amplitude Reference Accuracy</b>		±0.05 dB (nominal)
Preamp On <sup>c</sup> ( <i>Option 1DS</i> )	±(0.36 dB + frequency response)	±(0.09 dB + frequency response) (typical)
Preamp On <sup>d</sup> ( <i>Option 110</i> )	±(0.40 dB + frequency response)	±(0.15 dB + frequency response) (typical)

a. Absolute amplitude accuracy is the total of all amplitude measurement errors, and applies over the following subset of settings and conditions: 10 Hz ≤ RBW ≤ 1 MHz; Input signal –10 to –50 dBm; Input attenuation 10 dB; span <5 MHz (nominal additional error for span ≥ 5 MHz is 0.02 dB); all settings autocoupled except Auto Swp Time = Accy; combinations of low signal level and wide RBW use VBW ≤ 30 kHz to reduce noise.

This absolute amplitude accuracy specification includes the sum of the following individual specifications under the conditions listed above: Scale Fidelity, Reference Level Accuracy, Display Scale Switching Uncertainty, Resolution Bandwidth Switching Uncertainty, 50 MHz Amplitude Reference Accuracy, and the accuracy with which the instrument aligns its internal gains to the 50 MHz Amplitude Reference.

b. Absolute Amplitude Accuracy for a wide range of signal and measurement settings, with 95 % confidence, for the attenuation settings and frequency ranges shown. The wide range of settings of RBW, signal level, VBW, reference level and display scale are discussed in footnote a. The value given is computed from the observations of a statistically significant number of instruments. The computation includes the root-sum-squaring of these terms: the absolute amplitude accuracy observed at 50 MHz at 44 quasi-random combinations of settings and signal levels, the frequency response relative to 50 MHz at 102 quasi-random test frequencies, the attenuation switching uncertainty relative to 10 dB at 50 MHz, and the measurement uncertainties of these observations. To that root-sum-squaring result is added the environmental effects of 20 to 30 °C variation. The 95th percentiles are determined with 95 % confidence.

PSA Series Core Spectrum Analyzer  
**Amplitude**

- c. Same settings as footnote b, except that the signal level at the preamp input is  $-40$  to  $-80$  dBm. Total power at preamp (dBm) = total power at input (dBm) minus input attenuation (dB). For frequencies from 100 kHz to 3 GHz.
- d. Same settings as footnote b, except that the signal level at the preamp input is  $-40$  to  $-80$  dBm. Total power at preamp (dBm) = total power at input (dBm) minus input attenuation (dB). For frequencies from 10 MHz to the maximum frequency of the PSA instrument.



## RF Input VSWR

E4443A, E4445A, E4440A

Description	Specifications	Supplemental Information
<b>RF Input VSWR</b>		
at tuned frequency		Nominal
10 dB attenuation, 50 MHz		1.07:1
≥ 8 dB input attenuation		
50 MHz to 3 GHz		< 1.2:1
3 to 18 GHz		< 1.6:1
18 to 26.5 GHz		< 1.9:1
2 to 6 dB input attenuation		
50 MHz to 3 GHz		< 1.6:1
3 to 26.5 GHz		< 1.9:1
0 dB input attenuation		
50 MHz to 26.5 GHz		< 1.9:1
Preamp On ( <i>Option 1DS</i> )		
50 MHz to 3 GHz		
≥ 10 dB input attenuation		< 1.2:1
< 10 dB input attenuation		< 1.5:1
Preamp On ( <i>Option 110</i> )		
0 dB input attenuation		
200 MHz to 6.6 GHz		< 1.5:1
6.6 to 26.5 GHz		< 1.9:1
≥ 10 dB input attenuation		
200 MHz to 6.6 GHz		< 1.4:1
6.6 to 13.2 GHz		< 1.7:1
13.2 to 19.2 GHz		< 1.5:1
19.2 to 26.5 GHz		< 1.8:1
Alignments running		Open input

**E4447A, E4446A, E4448A**

Description	Specifications	Supplemental Information
<p><b>RF Input VSWR</b></p> <p>at tuned frequency</p> <p>10 dB attenuation, 50 MHz</p> <p>≥ 8 dB input attenuation</p> <p>50 MHz to 3 GHz</p> <p>3 to 18 GHz</p> <p>18 to 26.5 GHz</p> <p>26.5 to 50.0 GHz</p> <p>2 to 6 dB input attenuation</p> <p>50 MHz to 3 GHz</p> <p>3 to 18 GHz</p> <p>18 to 26.5 GHz</p> <p>26.5 to 50.0 GHz</p> <p>0 dB input attenuation</p> <p>50 MHz to 3 GHz</p> <p>3 to 18 GHz</p> <p>18 to 26.5 GHz</p> <p>26.5 to 50.0 GHz</p> <p>Preamp On (<i>Option 1DS</i>)</p> <p>50 MHz to 3 GHz</p> <p>≥ 10 dB input attenuation</p> <p>&lt; 10 dB input attenuation</p> <p>Preamp On (<i>Option 1I0</i>)</p> <p>0 dB input attenuation</p> <p>200 MHz to 6.6 GHz</p> <p>6.6 to 13.2 GHz</p> <p>13.2 to 31 GHz</p> <p>31 to 41 GHz</p> <p>41 to 50 GHz</p>		<p>Nominal</p> <p>&lt; 1.03:1</p> <p>&lt; 1.13:1</p> <p>&lt; 1.27:1</p> <p>&lt; 1.37:1</p> <p>&lt; 1.57:1</p> <p>&lt; 1.29:1</p> <p>&lt; 1.75:1</p> <p>&lt; 1.68:1</p> <p>&lt; 1.94:1</p> <p>&lt; 1.48:1</p> <p>&lt; 2.55:1</p> <p>&lt; 2.90:1</p> <p>&lt; 2.12:1</p> <p>&lt; 1.13:1</p> <p>&lt; 1.30:1</p> <p>&lt; 1.4:1</p> <p>&lt; 1.7:1</p> <p>&lt; 1.6:1</p> <p>&lt; 2.0:1</p> <p>&lt; 1.9:1</p>

Description	Specifications	Supplemental Information
10 dB input attenuation		
200 MHz to 6.6 GHz		< 1.3:1
6.6 to 13.2 GHz		< 1.5:1
13.2 to 31 GHz		< 1.4:1
31 to 41 GHz		< 1.8:1
41 to 50 GHz		< 1.7:1
> 10 dB input attenuation		
200 MHz to 6.6 GHz		< 1.2:1
6.6 to 13.2 GHz		< 1.4:1
13.2 to 19.2 GHz		< 1.3:1
19.2 to 31 GHz		< 1.5:1
31 to 50 GHz		< 1.7:1
Internal 50 MHz calibrator is On		Open input
Alignments running		Open input

Description	Specifications	Supplemental Information
<b>Resolution Bandwidth Switching Uncertainty<sup>a</sup></b> relative to reference BW of 30 kHz		
1.0 Hz to 1.0 MHz RBW	±0.03 dB	
1.1 MHz to 3 MHz RBW	±0.05 dB	
Manually selected wide RBWs: 4, 5, 6, 8 MHz	±1.0 dB	

- a. RBW switching is specified and tested in the reference condition: -25 dBm signal input and 10 dB input attenuation. At higher input levels, changing RBW may cause a larger change in result than that specified, because the display scale fidelity can be slightly different for different RBWs. These RBW differences in scale fidelity are nominally within ±0.01 dB in all RBWs even for signals as large as -10 dBm at the input mixer.

Description	Specifications	Supplemental Information
<b>Reference Level<sup>a</sup></b>  Range  Log Units  Linear Units  Accuracy	-170 to +30 dBm, in 0.01 dB steps  707 pV to 7.07 V, in 0.1 % steps  0 dB <sup>b</sup>	

- a. Reference level and off-screen performance: The reference level (RL) behavior differs from previous analyzers in a way that makes PSA more flexible. In previous analyzers, the RL controlled how the measurement was performed as well as how it was displayed. Because the logarithmic amplifier in previous analyzers had both range and resolution limitations, this behavior was necessary for optimum measurement accuracy. The logarithmic amplifier in PSA, however, is implemented digitally such that the range and resolution greatly exceed other instrument limitations. Because of this, a PSA can make measurements largely independent of the setting of the RL without compromising accuracy. Because the RL becomes a display function, not a measurement function, a marker can read out results that are off-screen, either above or below, without any change in accuracy. The only exception to the independence of RL and the way in which the measurement is performed is in the input attenuation setting: When the input attenuation is set to auto, the rules for the determination of the input attenuation include dependence on the reference level. Because the input attenuation setting controls the trade off between large signal behaviors (third-order intermodulation, compression, and display scale fidelity) and small signal effects (noise), the measurement results can change with RL changes when the input attenuation is set to auto.
- b. Because reference level affects only the display, not the measurement, it causes no additional error in measurement results from trace data or markers.

Description	Specifications	Supplemental Information
<p><b>Display Scale Switching Uncertainty</b></p> <p>Switching between Linear and Log</p> <p>Log Scale Switching</p> <p><b>Display Scale Fidelity</b><sup>b c d e</sup></p> <p>Log-Linear Fidelity (relative to the reference condition of –25 dBm input through the 10 dB attenuation, or –35 dBm at the input mixer)</p>	<p>0 dB<sup>a</sup></p> <p>0 dB<sup>a</sup></p>	

- a. Because Log/Lin and Log Scale Switching affect only the display, not the measurement, they cause no additional error in measurement results from trace data or markers.
- b. Supplemental information: The amplitude detection linearity specification applies at all levels below –10 dBm at the input mixer; however, noise will reduce the accuracy of low level measurements. The amplitude error due to noise is determined by the signal-to-noise ratio, S/N. If the S/N is large (20 dB or better), the amplitude error due to noise can be estimated from the equation below, given for the 3-sigma (three standard deviations) level.

$$3\sigma = 3(20dB)\log\langle 1 + 10^{-((S/N + 3dB)/20dB)} \rangle$$

- The errors due to S/N ratio can be further reduced by averaging results. For large S/N (20 dB or better), the 3 sigma level can be reduced proportional to the square root of the number of averages taken.
- c. Display scale fidelity and resolution bandwidth switching uncertainty interact slightly. See the footnote for RBW switching. RBW switching applies at only one level on the scale fidelity curve, but scale fidelity applies for all RBWs.
  - d. Scale fidelity is warranted with ADC dither turned on. Turning on ADC dither nominally increases DANL. The nominal increase is highest with the preamp off in the lowest-DANL frequency range, under 1.2 GHz, where the nominal increase is 2.5 dB. Other ranges and the preamp-on case will show lower increases in DANL. Turning off ADC dither nominally degrades low-level (signal levels below –60 dBm at the input mixer level) scale fidelity by 0.2 dB.
  - e. Reference level and off-screen performance: The reference level (RL) behavior differs from previous analyzers in a way that makes PSA more flexible. In previous analyzers, the RL controlled how the measurement was performed as well as how it was displayed. Because the logarithmic amplifier in previous analyzers had both range and resolution limitations, this behavior was necessary for optimum measurement accuracy. The logarithmic amplifier in PSA, however, is implemented digitally such that the range and resolution greatly exceed other instrument limitations. Because of this, a PSA can make measurements largely independent of the setting of the RL without compromising accuracy. Because the RL becomes a display function, not a measurement function, a marker can read out results that are off-screen, either above or below, without any change in accuracy. The only exception to the independence of RL and the way in which the measurement is performed is in the input attenuator setting: When the input attenuator is set to auto, the rules for the determination of the input attenuation include dependence on the reference level. Because the input attenuation setting controls the trade off between large signal behaviors (third-order intermodulation, compression, and display scale fidelity) and small signal effects (noise), the measurement results can change with RL changes when the input attenuation is set to auto.

Description	Specifications	Supplemental Information		
<b>Input mixer level<sup>a</sup></b>	<b>Linearity</b>			
$\leq -20$ dBm $\leq -10$ dBm		$\pm 0.07$ dB $\pm 0.13$ dB		
<b>Relative Fidelity<sup>b</sup></b>				
Equation for error $\pm A \pm ((B1 + B2) \times \Delta P)$ to a maximum of $(C1 + C2)$				
<b>Level of larger signal</b>		<b>A</b>	<b>B1</b>	<b>C1</b>
$-20$ dBm < ML < $-12$ dBm		0.011 dB	0.007	0.08 dB
$-29$ dBm < ML $\leq -20$ dBm		0.011 dB	0.0015	0.04 dB
Noise < ML $\leq -29$ dBm		0.001 dB	0.001	0.04 dB
<b>RBW</b>		<b>B2</b>	<b>C2</b>	
$\geq 10$ kHz		0.000	0.000 dB	
$\leq 2$ kHz		0.0035	0.038 dB	
others (RBW in Hz)		7/RBW	76 dB/RBW	

a. Mixer level = Input Level – Input Attenuator

b. The relative fidelity is the error in the measured difference between two signal levels. It is so small in many cases that it cannot be verified without being dominated by measurement uncertainty of the verification. Because of this verification difficulty, this specification gives nominal performance, based on numbers that are as conservatively determined as those used in warranted specifications. We will consider one example of the use of the error equation to compute the nominal performance.

Example: the accuracy of the relative level of a sideband around  $-60$  dBm, with a carrier at  $-5$  dBm, using attenuator = 10 dB and RBW = 3 kHz.

Because the larger signal is  $-5$  dBm with 10 dB attenuation, the mixer level, ML, defined to be input power minus input attenuation, is  $-15$  dBm. The line for this mixer level shows A = 0.011 dB, B1 = 0.007 and C1 = 0.08 dB. Because the RBW is neither 10 kHz and over, nor 2 kHz and under, parameters B2 and C2 are determined by formulas. B2 is  $7/3000$ , or 0.00233. C2 is  $76 \text{ dB}/3000$ , or 0.025 dB. With these values for the parameters, the equation becomes:  $\pm 0.011 \text{ dB} \pm (0.0093 \times \Delta P)$  to a maximum of 0.105 dB.  $\Delta P$  is  $(-5 - (-60))$  or 55 dB. Therefore, the maximum error in the power ratio is 0.116 dB.

Description	Specifications	Supplemental Information
Special Circumstances Relative Fidelity <sup>a</sup>  FFT, Span = 40 kHz, dither On, ML ≤ -28 dBm	$\pm(0.009 \text{ dB} + 0.003 \text{ dB per } 10 \text{ dB step}^b)$	

- a. Under very specific conditions, the PSA is warranted to have exceptional relative scale fidelity. The analysis frequency must be in Band 0. Sweep Type must be FFT with “FFTs/Span” set to 1, dither must be on, and the input attenuator must be set so that the ML (mixer level, given by Input Level – Attenuation) does not exceed -28 dBm. The span must be 40 kHz; wider spans will cause lower throughput, and narrower spans may have poorer fidelity. RBW of 75 Hz or lower is recommended. Average Type = Log improves the isolation of the measurement from the effects of noise. Further recommendations for achieving this fidelity are: 1) Detector = Sample 2) Signal to be CW 3) Analyzer and signal source to have their reference frequencies locked together 4) Analyzer center frequency = signal frequency + 2500 Hz 5) Sweep points = 401 6) Trace averaging on, 100 averages.
- b. “Step” in this specification refers to the difference between two relative measurements, such as might be experienced by stepping a stepped attenuator. Therefore, the relative fidelity accuracy is computed by adding the uncertainty for each full or partial 10 dB step to the other uncertainty term. For example, if the two levels whose relative level is to be determined differ by 15 dB; consider that to be a difference of two 10 dB steps. The relative accuracy specification would be  $\pm(0.009 + 2 \times (0.003))$  or  $\pm 0.015$  dB.

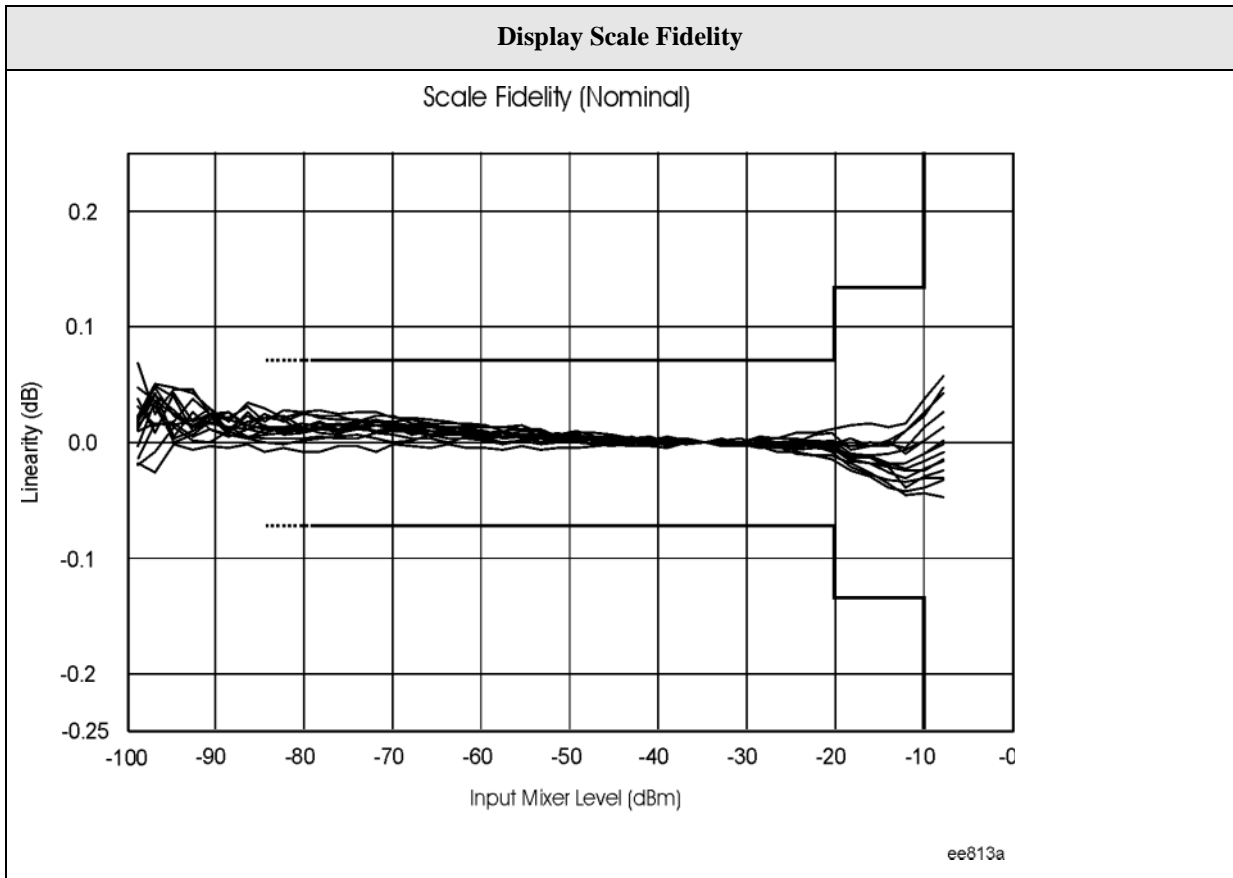

Description	Specifications	Supplemental Information
<p><b>Available Detectors</b></p> <p><b>EMI Detectors</b></p> <p>CISPR</p> <p>MIL-STD</p>	<p>Normal, Peak, Sample, Negative Peak, Log Power Average, RMS Average, Voltage Average</p> <p>Peak, Quasi-Peak, Average</p> <p>Peak</p>	



Description	Specifications	Supplemental Information
<b>EMI Average Detector</b>		Used for CISPR-compliant average measurements and, with 1 MHz RBW, for frequencies above 1 GHz
Default Average Type	Voltage	All filtering is done on the linear (voltage) scale even when the display scale is log.
Default VBW	1 Hz	

Description	Specifications	Supplemental Information
<b>Quasi-Peak Detector</b>		Used with CISPR-compliant RBWs, for frequencies $\leq 1$ GHz
Absolute Amplitude Accuracy for reference spectral intensities	Meets CISPR standards <sup>a</sup>	
Relative amplitude accuracy versus pulse repetition rate	Meets CISPR standards <sup>a</sup>	
Quasi-Peak to average response ratio	Meets CISPR standards <sup>a</sup>	
Dynamic range		
Pulse repetition rates $\geq 20$ Hz		Nominally meets CISPR standards <sup>a</sup>
Pulse repetition rates $\leq 10$ Hz		Does not meet CISPR standards in some cases with DC pulse excitation; see following table.

a. CISPR 16-1 (2002-10)

PSA Series Core Spectrum Analyzer  
Amplitude

Description	Specifications	Supplemental Information		
<b>Second Harmonic Distortion</b>	<b>SHI<sup>a</sup></b>	<b>Mixer Level<sup>b</sup></b> (typical)	<b>Distortion</b> (typical)	<b>SHI</b>
Source Frequency				
10 to 460 MHz	+42 dBm	-40 dBm	-82 dBc	
460 MHz to 1.18 GHz	+52 dBm	-40 dBm	-92 dBc	
1.18 to 1.5 GHz	+42 dBm	-40 dBm	-82 dBc	
1.5 to 2.0 GHz	+80 dBm	-10 dBm	-90 dBc	
2.0 to 3.25 GHz				
E4443A, E4445A, E4440A	+90 dBm	-10 dBm	-100 dBc	
E4447A, E4446A, E4448A	+84 dBm	-10 dBm	-94 dBc	
3.25 to 13.25 GHz				
E4443A, E4445A, E4440A	+90 dBm	-10 dBm	-100 dBc	
E4447A, E4446A, E4448	+86 dBm	-10 dBm	-96 dBc	
13.25 to 25.0 GHz				
E4443A, E4445A, E4440A		N/A		
E4447A, E4446A, E4448A		-10 dBm	-100 dBc (nominal)	+90dBm (nominal)
Preamp On ( <i>Option IDS</i> )		Preamp Level <sup>c</sup>		
10 MHz to 1.5 GHz		-45 dBm	-60 dBc (nominal)	+15 dBm (nominal)
Preamp On ( <i>Option I10</i> )		Preamp Level <sup>c</sup>		
10 to 460 MHz		-45 dBm	-55 dBc (nominal)	+10 dBm (nominal)
460 MHz to 25 GHz		-45 dBm	-60 dBc (nominal)	+15 dBm (nominal)

a. SHI = second harmonic intercept. The SHI is given by the mixer power in dBm minus the second harmonic distortion level relative to the mixer tone in dBc. The measurement is made with a -11 dBm tone at the input mixer.

b. Mixer level = Input Level - Input Attenuation

c. Preamp level = Input Level - Input Attenuation.

Description	Specifications	Supplemental Information
<p><b>General Spurious Responses</b></p> <p>Mixer Level<sup>a</sup> = -40 dBm</p> <p>100 Hz ≤ f &lt; 10 MHz from carrier</p> <p>f ≥ 10 MHz from carrier</p>	<p>(-73 + 20 log N) dBc<sup>b</sup></p> <p>(-80 + 20 log N) dBc<sup>b</sup></p>	<p>(-90 + 20 log N) dBc<sup>b</sup> (typical)</p>

- a. Mixer level = Input Level – Input Attenuation
- b. N = LO mixing harmonic

## Third Order Intermodulation Distortion

E4443A, E4445A, E4440A

Description	Specifications		Supplemental Information
<b>Third Order Intermodulation Distortion</b> Tone separation >15 kHz Sweep type not set to FFT			Verification conditions <sup>a</sup>
	<b>Distortion<sup>b</sup></b>	<b>TOI<sup>c</sup></b>	<b>TOI (typical)</b>
20 to 30 °C	Two -30 dBm tones		
10 to 100 MHz	-88 dBc	+14 dBm	+17 dBm
100 to 400 MHz	-90 dBc	+15 dBm	+18 dBm
400 MHz to 1.7 GHz	-92 dBc	+16 dBm	+19 dBm
1.7 to 2.7 GHz	-94 dBc	+17 dBm	+19 dBm
2.7 to 3 GHz	-94 dBc	+17 dBm	+20 dBm
3 to 6 GHz	-90 dBc	+15 dBm	+18 dBm
6 to 16 GHz	-76 dBc	+8 dBm	+11 dBm
16 to 26.5 GHz	-84 dBc	+12 dBm	+14 dBm
0 to 55 °C			
10 to 100 MHz	-86 dBc	+13 dBm	+17 dBm
100 to 400 MHz	-86 dBc	+13 dBm	+17 dBm
400 MHz to 2.7 GHz	-90 dBc	+15 dBm	+18 dBm
2.7 to 3 GHz	-90 dBc	+15 dBm	+18 dBm
3 to 6 GHz	-90 dBc	+15 dBm	+18 dBm
6 to 16 GHz	-74 dBc	+7 dBm	+10 dBm
16 to 26.5 GHz	-82 dBc	+11 dBm	+13 dBm

- TOI is verified with two tones, each at -18 dBm at the mixer, spaced by 100 kHz.
- Distortion for two tones that are each at -30 dBm is computed from TOI.
- TOI = third order intercept. The TOI is given by the mixer tone level (in dBm) minus (distortion/2) where distortion is the relative level of the distortion tones in dBc.

Description	Specifications	Supplemental Information
Preamp On ( <i>Option 1DS</i> )  10 to 500 MHz 500 MHz to 3 GHz		Verification conditions <sup>a</sup> TOI (nominal) -15 dBm -13 dBm
Preamp On ( <i>Option 110</i> )  10 MHz to 3 GHz 3 to 6.6 GHz 6.6 to 13.2 GHz 13.2 to 19 GHz 19 to 26.5 GHz		Verification conditions <sup>a</sup> TOI (nominal) - 15 dBm - 21 dBm - 23 dBm - 23 dBm - 25 dBm

a. TOI is verified with two tones each at -45 dBm at the preamp, spaced by 100 kHz.

E4447A, E4446A, E4448A

Description	Specifications		Supplemental Information
<b>Third Order Intermodulation Distortion</b> Tone separation >15 kHz Sweep type not set to FFT			Verification conditions <sup>a</sup>
	<b>Distortion<sup>b</sup></b>	<b>TOI<sup>c</sup></b>	<b>TOI (typical)</b>
20 to 30 °C	Two -30 dBm tones		
10 to 100 MHz	-90 dBc	+15 dBm	+20 dBm
100 to 400 MHz	-92 dBc	+16 dBm	+21 dBm
400 MHz to 1.7 GHz	-94 dBc	+17 dBm	+20 dBm
1.7 to 2.7 GHz	-96 dBc	+18 dBm	+21 dBm
2.7 to 3 GHz	-96 dBc	+18 dBm	+21 dBm
3 to 6 GHz	-92 dBc	+16 dBm	+21 dBm
6 to 16 GHz	-84 dBc	+12 dBm	+15 dBm
16 to 26.5 GHz	-84 dBc	+12 dBm	+16 dBm
26.5 to 50.0 GHz			+12.5 dBm (nominal)
0 to 55 °C			
10 to 100 MHz	-88 dBc	+14 dBm	+19 dBm
100 to 400 MHz	-91 dBc	+15.5 dBm	+20 dBm
400 MHz to 1.7 GHz	-92 dBc	+16 dBm	+19.5 dBm
1.7 to 2.7 GHz	-94 dBc	+17 dBm	+20 dBm
2.7 to 3 GHz	-93 dBc	+16.5 dBm	+20.5 dBm
3 to 6 GHz	-92 dBc	+16 dBm	+21 dBm
6 to 16 GHz	-84 dBc	+12 dBm	+14 dBm
16 to 26.5 GHz	-84 dBc	+12 dBm	+15 dBm
26.5 to 50.0 GHz			+12.5 dBm (nominal)

- TOI is verified with two tones, each at -18 dBm at the mixer, spaced by 100 kHz.
- Distortion for two tones that are each at -30 dBm is computed from TOI.
- TOI = third order intercept. The TOI is given by the mixer tone level (in dBm) minus (distortion/2) where distortion is the relative level of the distortion tones in dBc.

Description	Specifications	Supplemental Information
Preamp On ( <i>Option 1DS</i> )  10 to 500 MHz 500 MHz to 3 GHz		Verification conditions <sup>a</sup>  TOI (nominal) -15 dBm -13 dBm
Preamp On ( <i>Option 110</i> )  10 MHz to 3 GHz 3 to 6.6 GHz 6.6 to 13.2 GHz 13.2 to 19 GHz 19 to 26.5 GHz		Verification conditions <sup>a</sup>  TOI (nominal) -15 dBm -21 dBm -23 dBm -23 dBm -25 dBm

a. TOI is verified with two tones each at -45 dBm at the preamp, spaced by 100 kHz.

PSA Series Core Spectrum Analyzer  
Amplitude

Description	Specifications		Supplemental Information
<b>Other Input Related Spurious</b>	<b>Mixer Level<sup>a</sup></b>	<b>Distortion</b>	
Image Responses			
10 MHz to 26.8 GHz	-10 dBm	-80 dBc	
26.8 to 50 GHz	-30 dBm	-60 dBc	
Multiples and Out-of-band Responses			
10 MHz to 26.8 GHz	-10 dBm	-80 dBc	
26.8 to 50 GHz	-30 dBm	-50 dBc	
Residual Responses <sup>b</sup>			
200 kHz to 6.6 GHz		-100 dBm	
6.6 to 26.8 GHz			-100 dBm (nominal)
26.8 to 50 GHz			-90 dBm (nominal)

- a. Mixer Level = Input Level – Input Attenuation.
- b. Input terminated, 0 dB input attenuation.



## Dynamic Range

E4443A, E4445A, E4440A

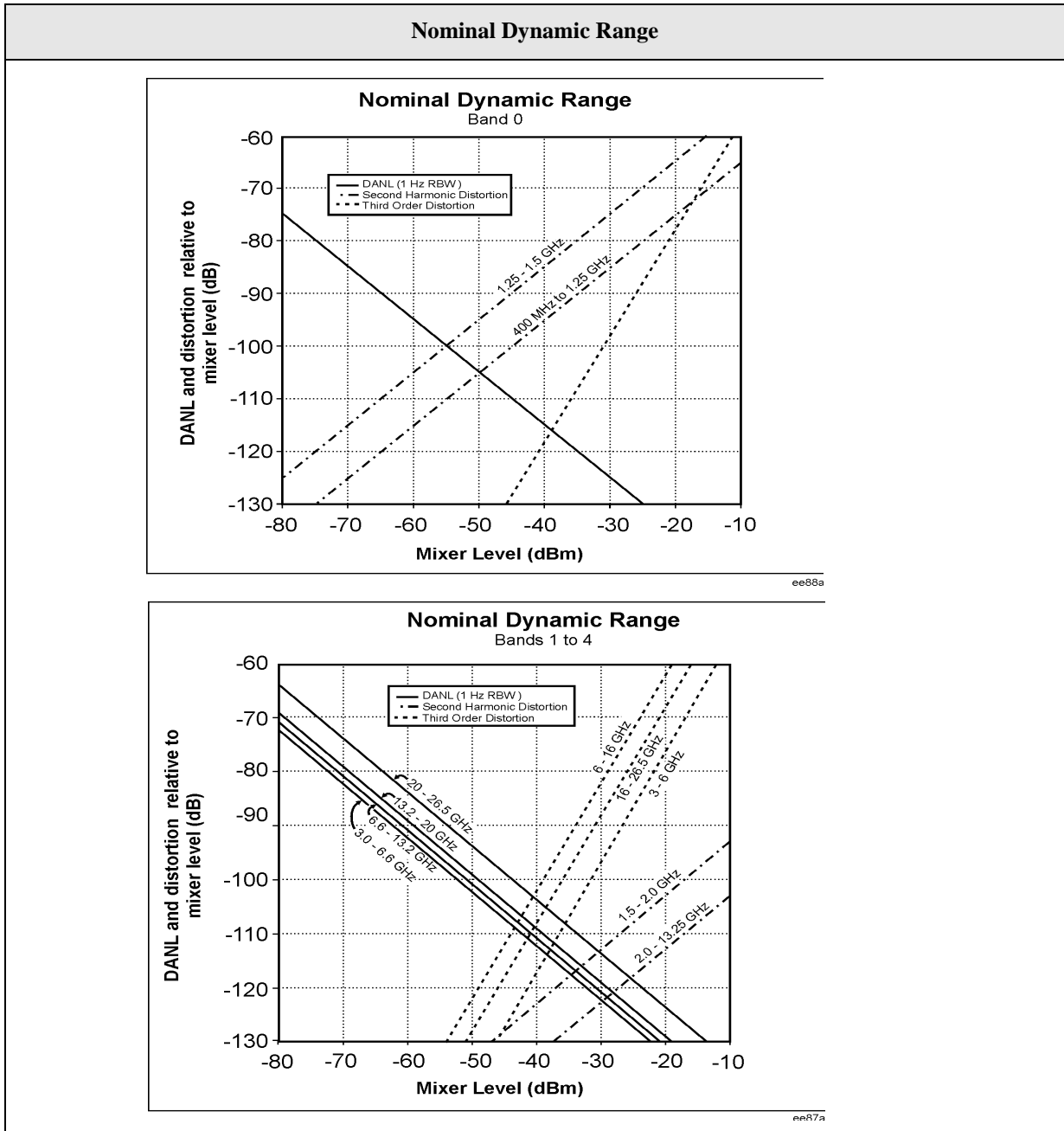

E4447A, E4446A, E4448A: Bands 0–4

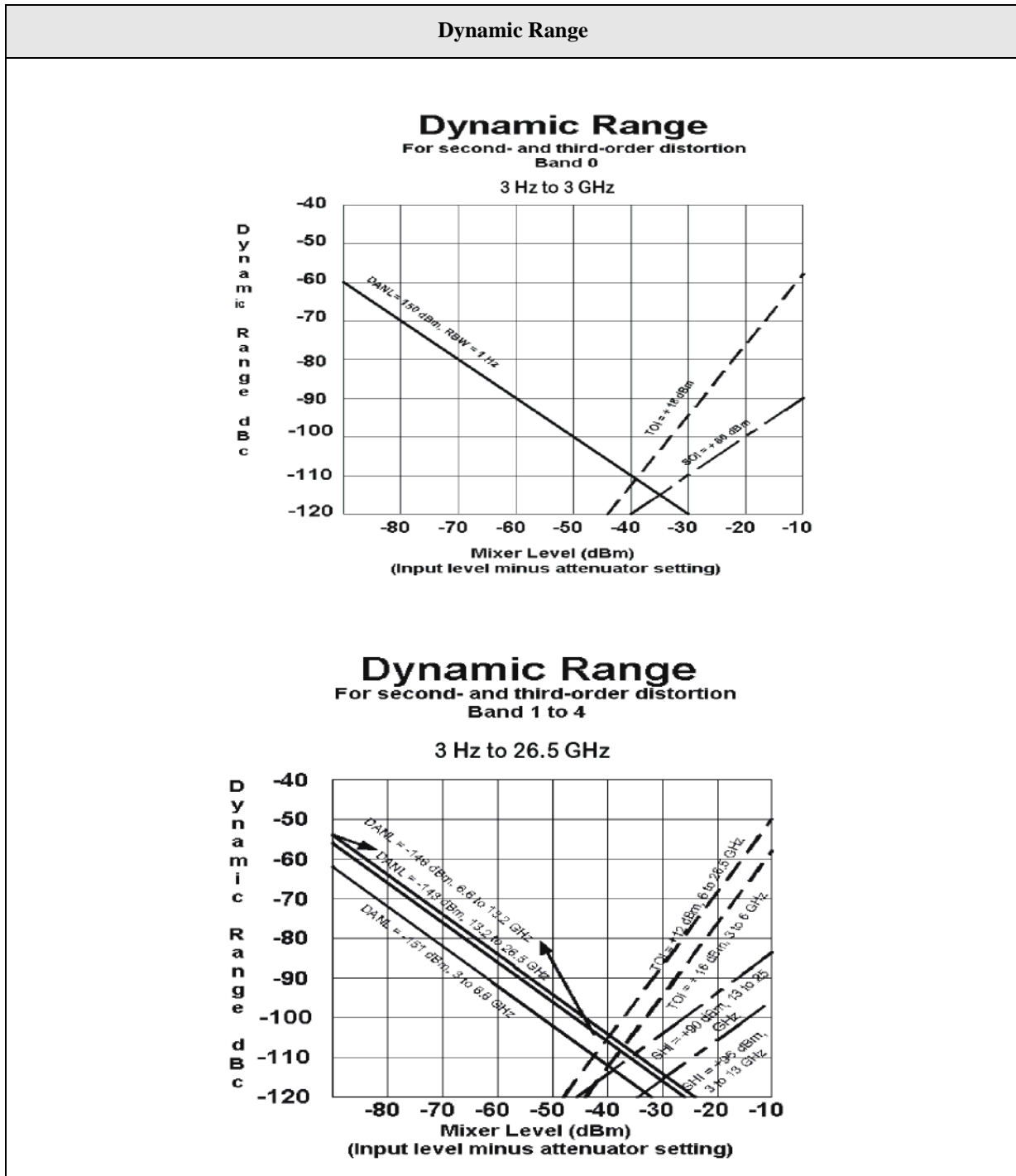

E4447A, E4446A, E4448A: Bands 5–6

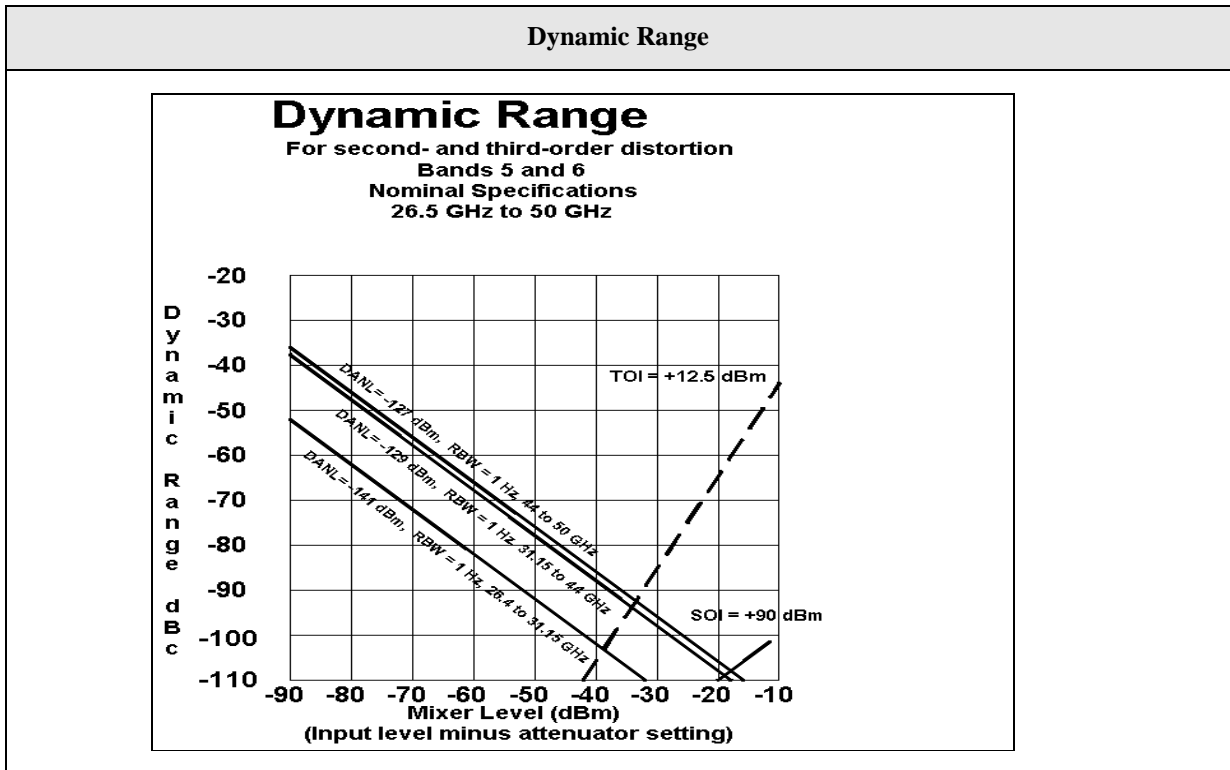

## Power Suite Measurements

Description	Specifications	Supplemental Information
<b>Channel Power</b> Amplitude Accuracy Radio Std = 3GPP W-CDMA, or IS-95 Absolute Power Accuracy 20 to 30 °C Mixer level <sup>d</sup> < -20 dBm	$\pm 0.68$ dB	Absolute Amplitude Accuracy <sup>a</sup> + Power Bandwidth Accuracy <sup>b c</sup> ±0.18 dB (typical)

- a. See Amplitude section.
- b. See Frequency section.
- c. Expressed in dB.
- d. Mixer level is the input power minus the input attenuation.

Description	Specifications	Supplemental Information
<b>Occupied Bandwidth</b> Frequency Accuracy		$\pm(\text{Span}/600)$ (nominal)

Description	Specifications	Supplemental Information
<p><b>Adjacent Channel Power (ACP)</b></p> <p><b>Radio Std = None</b></p> <p>Accuracy of ACP Ratio (dBc)</p> <p>Accuracy of ACP Absolute Power (dBm or dBm/Hz)</p> <p>Accuracy of Carrier Power (dBm), or Carrier Power PSD (dBm/Hz)</p> <p>Passband width<sup>e</sup></p>	<p>–3 dB</p>	<p>Display Scale Fidelity<sup>a</sup></p> <p>Absolute Amplitude Accuracy<sup>b</sup> + Power Bandwidth Accuracy<sup>c d</sup></p> <p>Absolute Amplitude Accuracy<sup>a</sup> + Power Bandwidth Accuracy<sup>c</sup></p>

- a. The effect of scale fidelity on the ratio of two powers is called the relative scale fidelity. The scale fidelity specified in the Amplitude section is an absolute scale fidelity with –35 dBm at the input mixer as the reference point. The relative scale fidelity is nominally only 0.01 dB larger than the absolute scale fidelity.
- b. See Amplitude section.
- c. See Frequency section.
- d. Expressed in decibels.
- e. An ACP measurement measures the power in adjacent channels. The shape of the response versus frequency of those adjacent channels is occasionally critical. One parameter of the shape is its 3 dB bandwidth. When the bandwidth (called the Ref BW) of the adjacent channel is set, it is the 3 dB bandwidth that is set. The passband response is given by the convolution of two functions: a rectangle of width equal to Ref BW and the power response versus frequency of the RBW filter used. Measurements and specifications of analog radio ACPs are often based on defined bandwidths of measuring receivers, and these are defined by their –6 dB widths, not their –3 dB widths. To achieve a passband whose –6 dB width is  $x$ , set the Ref BW to be  $x - 0.572 \times \text{RBW}$ .

Description	Specifications	Supplemental Information
<b>Adjacent Channel Power (ACP)</b> <b>Radio Std = 3GPP W-CDMA</b> Minimum power at RF Input		(ACPR; ACLR) <sup>a</sup> -36 dBm (nominal)

- a. Most versions of adjacent channel power measurements use negative numbers, in units of dBc, to refer to the power in an adjacent channel relative to the power in a main channel, in accordance with ITU standards. The standards for W-CDMA analysis include ACLR, a positive number represented in dB units. In order to be consistent with other kinds of ACP measurements, this measurement and its specifications will use negative dBc results, and refer to them as ACPR, instead of positive dB results referred to as ACLR. The ACLR can be determined from the ACPR reported by merely reversing the sign.

Description		Specifications	Supplemental Information
<b>Adjacent Channel Power (ACP)</b>			
ACPR Accuracy <sup>a</sup>			RRC weighted, 3.84 MHz noise bandwidth, method = IBW or Fast <sup>b</sup>
Radio	Offset Freq		
MS (UE)	5 MHz	±0.12 dB	At ACPR range of –30 to –36 dBc with optimum mixer level <sup>c</sup>
MS (UE)	10 MHz	±0.17 dB	At ACPR range of –40 to –46 dBc with optimum mixer level <sup>d</sup>
BTS	5 MHz	±0.22 dB <sup>b</sup>	At ACPR range of –42 to –48 dBc with optimum mixer level <sup>e</sup>
BTS	10 MHz	±0.22 dB	At ACPR range of –47 to –53 dBc with optimum mixer level <sup>d</sup>
BTS	5 MHz	±0.17 dB	At –48 dBc non-coherent ACPR <sup>f</sup>

- a. The accuracy of the Adjacent Channel Power Ratio will depend on the mixer drive level and whether the distortion products from the analyzer are coherent with those in the UUT. These specifications apply even in the worst case condition of coherent analyzer and UUT distortion products. For ACPR levels other than those in this specifications table, the optimum mixer drive level for accuracy is approximately –37 dBm – (ACPR/3), where the ACPR is given in (negative) decibels.
- b. The Fast method has a slight decrease in accuracy in only one case: for BTS measurements at 5 MHz offset, the accuracy degrades by ±0.01 dB relative to the accuracy shown in this table.
- c. To meet this specified accuracy when measuring mobile station (MS) or user equipment (UE) within 3 dB of the required –33 dBc ACPR, the mixer level (ML) must be optimized for accuracy. This optimum mixer level is –26 dBm, so the input attenuation must be set as close as possible to the average input power – (–26 dBm). For example, if the average input power is –6 dBm, set the attenuation to 20 dB. This specification applies for the normal 3.5 dB peak-to-average ratio of a single code. Note that if the mixer level is set to optimize dynamic range instead of accuracy, accuracy errors are nominally doubled.
- d. ACPR accuracy at 10 MHz offset is warranted when the input attenuator is set to give an average mixer level of –14 dBm.
- e. In order to meet this specified accuracy, the mixer level must be optimized for accuracy when measuring node B Base Transmission Station (BTS) within 3 dB of the required –45 dBc ACPR. This optimum mixer level is –22 dBm, so the input attenuation must be set as close as possible to the average input power – (–22 dBm). For example, if the average input power is –6 dBm, set the attenuation to 16 dB. This specification applies for the normal 10 dB peak-to-average ratio (at 0.01 % probability) for Test Model 1. Note that, if the mixer level is set to optimize dynamic range instead of accuracy, accuracy errors are nominally doubled.
- f. Accuracy can be excellent even at low ACPR levels assuming that the user sets the mixer level to optimize the dynamic range, and assuming that the analyzer and UUT distortions are incoherent. When the errors from the UUT and the analyzer are incoherent, optimizing dynamic range is equivalent to minimizing the contribution of analyzer noise and distortion to accuracy, though the higher mixer level increases the display scale fidelity errors. This incoherent addition case is commonly used in the industry and can be useful for comparison of analysis equipment, but this incoherent addition model is rarely justified.

PSA Series Core Spectrum Analyzer  
Power Suite Measurements

Description	Specification	Supplemental Information
<b>Adjacent Channel Power (ACP)</b>		
Dynamic Range		RRC weighted, 3.84 MHz noise bandwidth
<b>Noise Correction</b>	<b>Offset Freq</b> <b>Method</b>	
Off	5 MHz    IBW	-74.5 dB (typical) <sup>a b</sup>
Off	5 MHz    Fast	-73 dB (typical) <sup>a b</sup>
Off	10 MHz    either	-82 dB (typical) <sup>a b</sup>
On	5 MHz    either	-81 dB (typical) <sup>a c</sup>
On	10 MHz    either	-88 dB (typical) <sup>a b</sup>
RRC Weighting Accuracy <sup>d</sup>		
White noise in Adjacent Channel		0.00 dB nominal
TOI-induced spectrum		0.004 dB nominal
rms CW error		0.023 dB nominal

a. Agilent measures 100 % of PSAs for dynamic range in the factory production process. This measurement requires a near-ideal signal, which is impractical for field and customer use. Because field verification is impractical, Agilent only gives a typical result. More than 80 % of prototype PSAs met this “typical” specification; the factory test line limit is set commensurate with an on-going 80 % yield to this typical.

The ACPR dynamic range is verified only at 2 GHz, where Agilent has the near-perfect signal available. The dynamic range is specified for the optimum mixer drive level, which is different in different instruments and different conditions. The test signal is a 1 DPCH signal.

The ACPR dynamic range is the observed range. This typical specification includes no measurement uncertainty.

b. The optimum mixer drive level will be approximately -12 dBm.

c. The optimum mixer drive level will be approximately -15 dBm.



- d. 3GPP requires the use of a root-raised-cosine filter in evaluating the ACLR of a device. The accuracy of the passband shape of the filter is not specified in standards, nor is any method of evaluating that accuracy. This footnote discusses the performance of the filter in this instrument. The effect of the RRC filter and the effect of the RBW used in the measurement interact. The analyzer compensates the shape of the RRC filter to accommodate the RBW filter. The effectiveness of this compensation is summarized in three ways:
- White noise in Adj Ch: The compensated RRC filter nominally has no errors if the adjacent channel has a spectrum that is flat across its width.
  - TOI-induced spectrum: If the spectrum is due to third-order intermodulation, it has a distinctive shape. The computed errors of the compensated filter are  $-0.004$  dB for the 470 kHz RBW used for UE testing with the IBW method and also used for all testing with the Fast method, and 0.000 dB for the 30 kHz RBW filter used for BTS testing with the IBW method. The worst error for RBWs between these extremes is 0.05 dB for a 330 kHz RBW filter.
  - rms CW error: This error is a measure of the error in measuring a CW-like spurious component. It is evaluated by computing the root of the mean of the square of the power error across all frequencies within the adjacent channel. The computed rms error of the compensated filter is 0.023 dB for the 470 kHz RBW used for UE testing with the IBW method and also used for all testing with the Fast method, and 0.000 dB for the 30 kHz RBW filter used for BTS testing. The worst error for RBWs between these extremes is 0.057 dB for a 430 kHz RBW filter.

Description	Specifications	Supplemental Information
<p><b>Adjacent Channel Power (ACP)</b></p> <p><b>Radio Std = IS-95 or J-STD-008</b></p> <p>Method</p> <p>ACPR Relative Accuracy</p> <p>Offsets &lt; 1300 kHz<sup>b</sup></p> <p>Offsets &gt; 1.85 MHz<sup>c</sup></p>	<p>±0.10 dB</p> <p>±0.10 dB</p>	<p>RBW method<sup>a</sup></p>

a. The RBW method measures the power in the adjacent channels within the defined resolution bandwidth. The noise bandwidth of the RBW filter is nominally 1.055 times the 3.01 dB bandwidth. Therefore, the RBW method will nominally read 0.23 dB higher adjacent channel power than would a measurement using the integration bandwidth method, because the noise bandwidth of the integration bandwidth measurement is equal to that integration bandwidth. For cdmaOne ACPR measurements using the RBW method, the main channel is measured in a 3 MHz RBW, which does not respond to all the power in the carrier. Therefore, the carrier power is compensated by the expected under-response of the filter to a full width signal, of 0.15 dB. But the adjacent channel power is not compensated for the noise bandwidth effect.

The reason the adjacent channel is not compensated is subtle. The RBW method of measuring ACPR is very similar to the preferred method of making measurements for compliance with FCC requirements, the source of the specifications for the cdmaOne Spur Close specifications. ACPR is a spot measurement of Spur Close, and thus is best done with the RBW method, even though the results will disagree by 0.23 dB from the measurement made with a rectangular passband.

b. The specified ACPR accuracy applies if the measured ACPR substantially exceeds the analyzer dynamic range at the specified offset. When this condition is not met, there are additional errors due to the addition of analyzer spectral components to UUT spectral components. In the worst case at these offsets, the analyzer spectral components are all coherent with the UUT components; in a more typical case, one third of the analyzer spectral power will be coherent with the distortion components in the UUT. Coherent means that the phases of the UUT distortion components and the analyzer distortion components are in a fixed relationship, and could be perfectly in-phase. This coherence is not intuitive to many users, because the signals themselves are usually pseudo-random; nonetheless, they can be coherent.

When the analyzer components are 100 % coherent with the UUT components, the errors add in a voltage sense. That error is a function of the signal (UUT ACPR) to noise (analyzer ACPR dynamic range limitation) ratio, SN, in decibels.

The function is  $\text{error} = 20 \times \log(1 + 10^{-\text{SN}/20})$

For example, if the UUT ACPR is -62 dB and the measurement floor is -82 dB, the SN is 20 dB and the error due to adding the analyzer distortion to that of the UUT is 0.83 dB.

- c. As in the previous footnote, the specified ACPR accuracy applies if the ACPR measured substantially exceeds the analyzer dynamic range at the specified offset. When this condition is not met, there are additional errors due to the addition of analyzer spectral components to UUT spectral components. Unlike the situation in footnote b, though, the spectral components from the analyzer will be noncoherent with the components from the UUT. Therefore, the errors add in a power sense. The error is a function of the signal (UUT ACPR) to noise (analyzer ACPR dynamic range limitation) ratio, SN, in decibels.

The function is  $\text{error} = 10 \times \log(1 + 10^{-SN/10})$ .

For example, if the UUT ACPR is  $-75$  dB and the measurement floor is  $-85$  dB, the SN ratio is 10 dB and the error due to adding the analyzer's noise to that of the UUT is 0.41 dB.

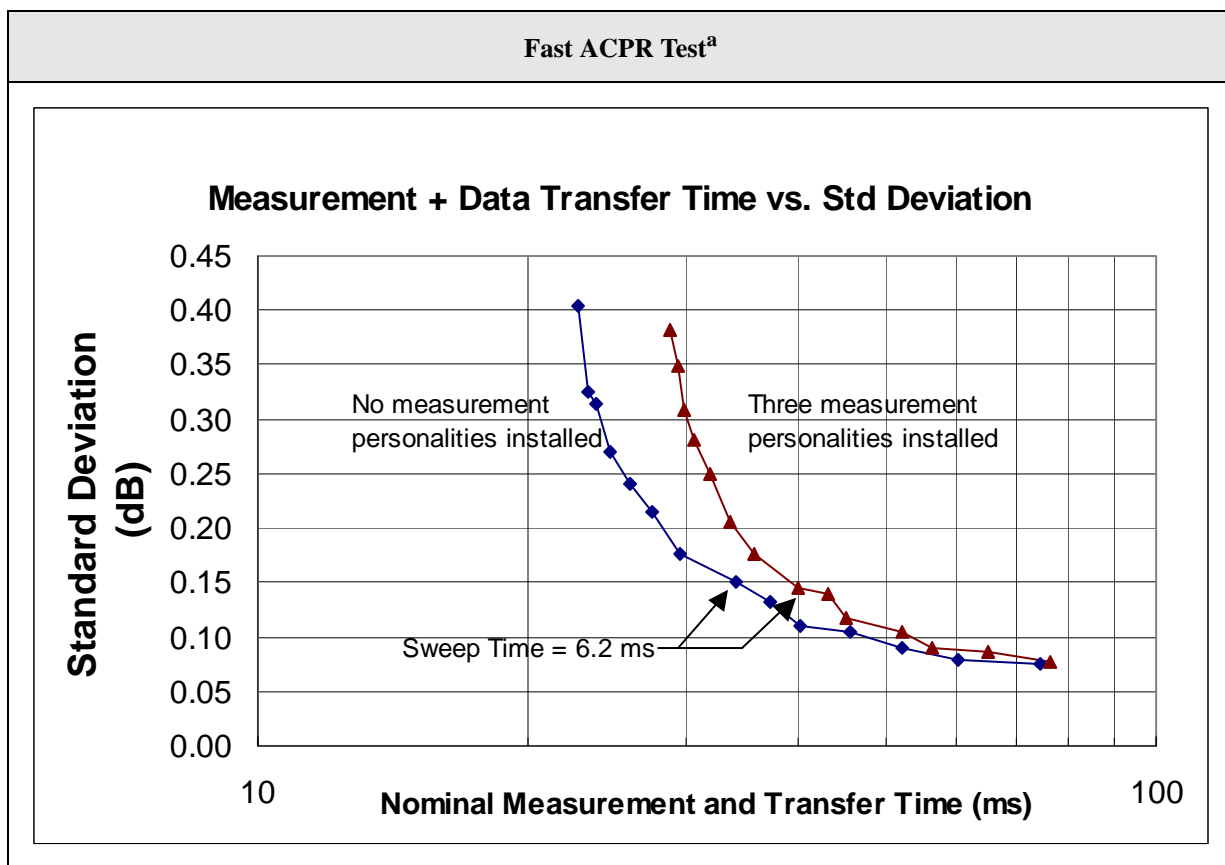

- a. Observation conditions for ACP speed:  
Display Off, signal is Test Model 1 with 64 DPCH, Method set to Fast. Measured with: an IBM compatible PC with a 3 GHz Pentium 4, running Windows XP Professional Version 2002. The communications medium was PCI GPIB IEEE 488.2. The Test Application Language was .NET - C#. The Application Communication Layer was Agilent T&M Programmer's Toolkit for Visual Studio (Version 1.1), Agilent I/O Libraries (Version M).

PSA Series Core Spectrum Analyzer  
Power Suite Measurements

Description	Specifications	Supplemental Information
<b>Multi-Carrier Power</b>		
Radio Std - 3GPP W-CDMA		RRC weighted, 3.84 MHz noise bandwidth
ACPR Dynamic Range 5 MHz offset Two carriers		-70 dB (nominal)
ACPR Accuracy Two carriers 5 MHz offset, -48 dBc ACPR		±0.38 dB (nominal)
ACPR Accuracy 4 carriers		
<b>Radio</b> <b>Offset</b> <b>Coher<sup>a</sup></b> <b>NC</b>		<b>UUT ACPR Range</b> <b>MLOpt<sup>b</sup></b>
BTS    5 MHz    no    Off	±0.24 dB	-42 to -48 dB    -17 dBm
BTS    5 MHz    no    On	±0.11 dB	-42 to -48 dB    -20 dBm
ACPR Dynamic Range 4 carriers 5 MHz offset		Nominal DR    Nominal MLOpt <sup>b</sup>
Noise Correction (NC) off		66 dB    -14 dBm
Noise Correction (NC) on		76 dB    -17 dBm

- a. Coher = no means that the specified accuracy only applies when the distortions of the device under test are not coherent with the third-order distortions of the analyzer. Incoherence is often the case with advanced multicarrier amplifiers built with compensations and predistortions that mostly eliminate coherent third-order effects in the amplifier.
- b. Optimum mixer level (MLOpt). The mixer level is given by the average power of the sum of the four carriers minus the input attenuation.

Description	Specifications	Supplemental Information
<b>Power Statistics CCDF</b>  Histogram Resolution <sup>a</sup>	0.1 dB	

- a. The Complementary Cumulative Distribution Function (CCDF) is a reformatting of a histogram of the power envelope. The width of the amplitude bins used by the histogram is the histogram resolution. The resolution of the CCDF will be the same as the width of those bins.

Description	Specifications	Supplemental Information
<b>Intermod (TOI)</b>		Measures the third-order intercept from a signal with two dominant tones

Description	Specifications	Supplemental Information
<b>Harmonic Distortion</b>  Maximum harmonic number  Results		10th  Fundamental power (dBm) Relative harmonics power (dBc)

Description	Specifications	Supplemental Information
<b>Burst Power</b>  Methods  Results		Power above threshold Power within burst width  Output power, average Output power, single burst Maximum power Minimum power within burst Burst width

Description	Specifications	Supplemental Information
<b>Spurious Emissions</b> W-CDMA signals  Dynamic Range, relative 1980 MHz region <sup>a</sup>  Sensitivity, absolute 1980 MHz region <sup>b</sup>	  80.6 dB  -89.7 dBm	Table-driven spurious signals; search across regions  82.4 dB (typical)  -91.7 dBm (typical)

- a. The dynamic range specification is the ratio of the channel power to the power in the region specified. The dynamic range depends on the many measurement settings. These specifications are based on the detector being set to average, the default RBW (1200 kHz), and depend on the mixer level. Mixer level is defined to be the input power minus the input attenuation. This dynamic range specification applies for a mixer level of -8 dBm. Higher mixer levels can give up to 5 dB better dynamic range, but at the expense of compression in the input mixer, which reduces accuracy. The compression behavior of the input mixer is specified in the amplitude section of these specifications.
- b. The sensitivity for this region is specified in the default 1200 kHz bandwidth, at a center frequency of 1 GHz.

Description	Specifications	Supplemental Information
<b>Spectrum Emission Mask</b>		Table-driven spurious signals; measurement near carriers
Radio Std = cdma2000		
Dynamic Range, relative 750 kHz offset <sup>a b</sup>	85.3 dB	88.3 dB (typical)
Sensitivity, absolute 750 kHz offset <sup>c</sup>	-105.7 dBm	-107 dBm (typical)
Accuracy, relative 750 kHz offset <sup>d</sup>	±0.09 dB	
Radio Std = 3GPP W-CDMA		
Dynamic Range, relative 2.515 MHz offset <sup>a e</sup>	87.3 dB	89.5 dB (typical)
Sensitivity, absolute 2.515 MHz offset <sup>c</sup>	-105.7 dBm	-107.7 dBm (typical)
Accuracy 2.515 MHz offset <sup>d</sup>		
Relative	±0.10 dB	
Absolute	±0.62 dB	±0.24 dB (95% confidence)
Absolute <sup>f</sup> (20 – 30 °C)		

- a. The dynamic range specification is the ratio of the channel power to the power in the offset specified. The dynamic range depends on the measurement settings, such as peak power or integrated power. Dynamic range specifications are based on default measurement settings, with detector set to average, and depend on the mixer level. Default measurement settings include 30 kHz RBW.
- b. This dynamic range specification applies for the optimum mixer level, which is about -18 dBm. Mixer level is defined to be the average input power minus the input attenuation.
- c. The sensitivity is specified with 0 dB input attenuation. It represents the noise limitations of the analyzer. It is tested without an input signal. The sensitivity at this offset is specified in the default 30 kHz RBW, at a center frequency of 2 GHz.
- d. The relative accuracy is a measure of the ratio of the power at the offset to the main channel power. It applies for spectrum emission levels in the offsets that are well above the dynamic range limitation.
- e. This dynamic range specification applies for the optimum mixer level, which is about -16 dBm. Mixer level is defined to be the average input power minus the input attenuation.
- f. The absolute accuracy of SEM measurement is the same as the absolute accuracy of the spectrum analyzer. See the above signal analyzer Absolute Amplitude Accuracy, for more information. The numbers shown are for 0 - 3 GHz, with attenuation set to 10 dB.

## Options

The following options affect instrument specifications.

<b>Option 110:</b>	RF/ $\mu$ Wave Internal Preamplifier
<b>Option 122:</b>	80 MHz Bandwidth Digitizer
<b>Option 123:</b>	Switchable MW Preselector Bypass
<b>Option 124:</b>	Y-axis Video Output
<b>Option 140:</b>	40 MHz Bandwidth Digitizer
<b>Option 1DS:</b>	RF Internal Preamplifier
<b>Option 202:</b>	GSM with EDGE Measurement Personality
<b>Option 204:</b>	1xEV-DO Measurement Personality
<b>Option 210:</b>	HSDPA/HSUPA Measurement Personality
<b>Option 212:</b>	TD-SCDMA Modulation Analysis Measurement Personality
<b>Option 213:</b>	HSDPA/8PSK for TD-SCDMA Modulation Analysis
<b>Option 214:</b>	1xEV-DV Measurement Personality
<b>Option 217</b>	WLAN Measurement Personality
<b>Option 219:</b>	Noise Figure Measurement Personality
<b>Option 226:</b>	Phase Noise Measurement Personality
<b>Option 233:</b>	Measuring Receiver Personality
<b>Option 235:</b>	Wide Bandwidth Digitizer External Calibration Wizard
<b>Option 239:</b>	EMI Receiver Personality
<b>Option 241:</b>	Flexible Digital Modulation Analysis Measurement Personality
<b>Option AYZ:</b>	External Mixing
<b>Option B78:</b>	cdma2000 Measurement Personality
<b>Option B7J:</b>	Digital Demodulation Hardware
<b>Option BAC:</b>	cdmaOne Measurement Personality
<b>Option BAE:</b>	NADC, PDC Measurement Personalities
<b>Option BAF:</b>	W-CDMA Measurement Personality



## General

Description	Specifications	Supplemental Information
<b>Calibration Cycle</b>	2 years	Recommended

Description	Specifications	Supplemental Information
<b>Environmental</b>		<p>Samples of this product have been tested in accordance with the Agilent Environmental Test Manual and verified to be robust against the environmental stresses of Storage, Transportation and End-use; those stresses include but are not limited to temperature, humidity, shock, vibration, altitude and power line conditions.</p> <p>Test Methods are aligned with IEC 60068-2 and levels are similar to MIL-PRF-28800F Class 3.</p>
Line power (single phase)	100/120V, 50/60/400 Hz 220/240V, 50/60 Hz	
Maximum	450 W	
Temperature range		
Operating	0 °C to +55 °C	
Storage	-40 °C to +70 °C	
Humidity		
Maximum Operating	95% at 40 °C (non-condensing)	
Minimum Operating	15% at 40 °C (non-condensing)	
Maximum Non-operating	90% at 65 °C (non-condensing)	
Altitude	0 to 4500 m (14,760 ft.)	
Magnetic Susceptibility		<p>Degradation of some product specifications can occur in the presence of ambient power frequency magnetic fields of 30 A/m or greater. The product self-recovers and operates as specified when removed or shielded from the ambient magnetic field.</p>

PSA Series Core Spectrum Analyzer  
General

Description	Specifications	Supplemental Information
Vibration		Degradation of some product specifications can occur if this instrument is operated while subjected to continuous vibrations > 0.21 grms in the 5 to 500 Hz frequency range.

Description	Specifications	Supplemental Information
<p><b>Measurement Speed</b></p> <p>Local measurement and display update rate<sup>a</sup></p> <p>Sweep points = 101 Sweep points = 401 Sweep points = 601</p> <p>Remote measurement and GPIB transfer rate<sup>a b</sup></p> <p>Sweep points = 101 Sweep points = 401 Sweep points = 601</p> <p>W-CDMA ACLR measurement time</p> <p>Measurement Time vs. Span</p>		<p>nominal</p> <p>≥ 50/s ≥ 50/s ≥ 50/s</p> <p>≥ 45/s ≥ 30/s ≥ 25/s</p> <p>See <a href="#">page 91</a></p> <p>See <a href="#">page 29</a></p>

- a. Factory preset, fixed center frequency, RBW = 1 MHz, and span >10 MHz and ≤ 600 MHz, and stop frequency ≤ 3 GHz, Auto Align Off.
- b. LO = Fast Tuning, Display Off, 32 bit integer format, markers Off, single sweep, measured with IBM compatible PC with 1.1 GHz Pentium Pro running Windows NT4.0, one meter GPIB cable, National Instruments PCI-GPIC Card and NI-488.2 DLL.

Description	Specifications	Supplemental Information
<b>Display<sup>a</sup></b>		
Resolution	640 × 480	
Size		213 mm (8.4 in) diagonal (nominal)
Scale		
Log Scale	0.1, 0.2, 0.3...1.0, 2.0, 3.0...20 dB per division	
Linear Scale	10 % of reference level per division	
Units	dBm, dBmV, dBmA, Watts, Volts, Amps, dBmV, dBmA, dBmV/m, dBmA/m, dBpT, dBG	

- a. The LCD display is manufactured using high precision technology. However, there may be up to six bright points (white, blue, red or green in color) that constantly appear on the LCD screen. These points are normal in the manufacturing process and do not affect the measurement integrity of the product in any way.

Description	Specifications	Supplemental Information
<b>Volume Control and Headphone Jack</b>		Reserved for future applications

Description	Specifications	Supplemental Information
<b>Data Storage</b>		
Internal		64 MB (nominal)
With <i>Option 115</i>		512 MB (nominal)
With <i>Option 117</i>		512 MB (nominal)
Floppy Drive (10 to 40 °C)		3.5" 1.44 MB, MS-DOS®, compatible

PSA Series Core Spectrum Analyzer  
**General**

Description	Specifications	Supplemental Information
<b>Weight</b> (without options)		
Net E4440A, E4443A, E4445A		23 kg (50 lb) (nominal)
Net E4447A, E4446A, E4448A		24 kg (53 lb) (nominal)
Shipping		33 kg (73 lb) (nominal)
<b>Cabinet Dimensions</b>		Cabinet dimensions exclude front and rear protrusions.
Height	177 mm (7.0 in)	
Width	426 mm (16.8 in)	
Length	483 mm (19 in)	

## Inputs/Outputs (Front Panel)

### RF Input

#### E4443A, E4445A, E4440A

Description	Specifications	Supplemental Information
<b>RF Input</b>		Nominal
Connector		
E4440A		
Standard	Type-N female	
<i>Option BAB</i>	APC 3.5 male	
E4443A, E4445A	Type-N female	
Impedance		50 $\Omega$ (see RF Input VSWR)
First LO Emission Level <sup>a</sup>		Band 0                      Bands $\geq$ 1 < -120 dBm                  < -100 dBm

- a. With 10 dB attenuation and RF preselector ON. Refer to Chapter 20 (Option 123, Switchable MW pre-selector bypass specifications) for the nominal performance of the “First LO emission level” when the preselector is OFF (or bypassed). See [page 323](#).

#### E4447A, E4446A, E4448A

Description	Specifications	Supplemental Information
<b>RF Input</b>		Nominal
Connector	2.4 mm male	
Impedance		50 $\Omega$ (see RF Input VSWR)
First LO Emission Level <sup>a</sup>		Band 0                      Bands $\geq$ 1 < -120 dBm                  < -100 dBm

- a. With 10 dB attenuation and RF preselector ON. Refer to Chapter 20 (Option 123, Switchable MW pre-selector bypass specifications) for the nominal performance of the “First LO emission level” when the preselector is OFF (or bypassed). See [page 323](#).

### Option AYZ External Mixing

Description	Specifications	Supplemental Information
<b>IF Input</b>		
Connector	SMA, female	
Impedance		50 $\Omega$ (nominal)
Center Frequency	321.4 MHz	
3 dB bandwidth		60 MHz (nominal)
Maximum Safe Input Level	+10 dBm	
Absolute Amplitude Accuracy	20–30 °C $\pm 1.2$ dB	0–55 °C $\pm 2.5$ dB
VSWR		<1.5:1 (nominal)
1 dB Gain Compression		0 dBm (nominal)
<b>Mixer Bias Current</b>		
Range	$\pm 10$ mA	
Resolution	0.01 mA	
Accuracy		$\pm 0.02$ mA (nominal)
Output Impedance		477 $\Omega$ (nominal)
<b>Mixer Bias Voltage</b>		
Range		$\pm 3.7$ V (measured in an open circuit)

Description	Specifications		Supplemental Information
<b>LO Output</b>			
Connector	SMA, female		
Impedance			50 $\Omega$ (nominal)
Frequency Range	3.05 to 6.89 GHz		
VSWR			<2.0:1 (nominal)
Power Out	20 to 30 °C	0 to 55 °C	
E4440A			
3.05 to 6.0 GHz	+14.5 to +18.5 dBm	+14.5 to +19.0 dBm	
6.0 to 6.89 GHz	+13.5 to +18.5 dBm	+13.5 to +19.0 dBm	
E4447A, E4446A, E4448A			
3.05 to 3.2 GHz	+14.5 to +20.0 dBm	+14.0 to +20.5 dBm	
3.2 to 6.0 GHz	+14.5 to +18.8 dBm	+14.0 to +19.3 dBm	
6.0 to 6.89 GHz			+14.5 to +18.5 dBm (nominal)

## Rear Panel

Description	Specifications	Supplemental Information
<b>10 MHz Out (Switched)</b>		Switchable On/Off
Connector	BNC female	
Impedance		50 Ω (nominal)
Output Amplitude		≥ 0 dBm (nominal)
Frequency	10 MHz ± (10 MHz × frequency reference accuracy)	

Description	Specifications	Supplemental Information
<b>Ext Ref In</b>		
Connector	BNC female	Note: Analyzer noise sidebands and spurious response performance may be affected by the quality of the external reference used.
Impedance		50 Ω (nominal)
Input Amplitude Range		-5 to +10 dBm (nominal)
Input Frequency		1 to 30 MHz (nominal) (selectable to 1 Hz resolution)
Lock range	$\pm 5 \times 10^{-6}$ of selected external reference input frequency	



Description	Specifications	Supplemental Information
<b>Trigger In</b>		Trigger source may be selected from front or rear.
Connector	BNC female	
External Trigger Input		
Impedance		10 k $\Omega$ (nominal)
Trigger Level Range	-5 to +5 V	1.5 V (TTL) factory preset

Description	Specifications	Supplemental Information
<b>Keyboard</b>		
Connector	6-pin mini-DIN (PS2)	Factory use and for firmware upgrades only.

Description	Specifications	Supplemental Information
<b>Trigger 1 and Trigger 2 Outputs</b>		
Connector	BNC female	
Trigger 1 Output		HSWP (High = sweeping)
Impedance		50 $\Omega$ (nominal)
Level		5 V TTL
Trigger 2 Output		Reserved for future applications
		50 $\Omega$ (nominal)
		5V CMOS logic levels

Description	Specifications	Supplemental Information
<b>Monitor Output</b>		
Connector	VGA compatible,	
Format	15-pin mini D-SUB	VGA (31.5 kHz horizontal, 60 Hz vertical sync rates, non-interlaced) Analog RGB
Resolution	640 $\times$ 480 pixels	

PSA Series Core Spectrum Analyzer  
Rear Panel

Description	Specifications	Supplemental Information
<b>Pre-Sel Tune Out</b>  Connector Load Impedance (dc Coupled) Range  Sensitivity External Mixer	BNC female	Used by <i>Option AYZ</i>  110 W (nominal) 0 to 10 V (nominal)  1.5V/GHz of tuned LO frequency (nominal)

Description	Specifications	Supplemental Information
<b>Preselector Tune Voltage</b>		1.5 V/GHz of tuned LO frequency (nominal)

Description	Specifications	Supplemental Information
<b>Noise Source Drive Output</b>  Connector  Output Voltage On Off	BNC female  28.0 ±0.1 V < 1 V	Used by <i>Option 219</i>  60 mA maximum

Description	Specifications	Supplemental Information
<b>GPIB Interface</b>		
Connector	IEEE-488 bus connector	
GPIB Codes		SH1, AH1, T6, SR1, RL1, PP0, DC1, C1, C2, C3 and C28, DT1, L4, C0
<b>Serial Interface</b>		
Connector	9-pin D-SUB male	Factory use only
<b>Parallel Interface</b>		
Connector	25-pin D-SUB female	Printer port only
<b>LAN TCP/IP Interface</b>	RJ45 Ethertwist	
<b>USB 2.0 Interface (Option III)</b>	USB Type B connector	Slave mode only, device-side, USB 2.0 compliant

### 321.4 MHz IF Output

Description	Specifications	Supplemental Information
<b>321.4 MHz IF Output</b>		
Connector	SMA female	
Impedance		50 $\Omega$ (nominal)
Frequency		321.4 MHz (nominal)
Conversion Gain		
Low band (3 Hz to 3.05 GHz)		+2 to +4 dB (nominal)
High / mm band (2.85 GHz to analyzer upper frequency limit)		-6 to -8 dB (nominal)
High / mm band (2.85 GHz to analyzer upper frequency limit) Preselector off (Option 123)		-9 to -17 dB (nominal)
Bandwidth (-3 dB)		
Low band (3 Hz to 3.05 GHz)		40 MHz or 60 MHz <sup>a</sup> (nominal)
High band (2.85 to 26.5 GHz)		35 to 70 MHz <sup>b</sup> (nominal)
mm band (26.5 to 50 GHz)		40 MHz or 60 MHz <sup>a</sup> (nominal)

PSA Series Core Spectrum Analyzer  
Rear Panel





Description	Specifications	Supplemental Information
High / mm band (2.85 GHz to analyzer upper frequency limit) Preselector off (Option 123)  External Mixing		240 MHz (nominal)  Dependent on mixer used. See Mixer specs.

- a. 40 MHz standard, 60 MHz with option 122 or 140 installed in the instrument. When option 122 or 140 is installed, the IF Output port signal is now centered at 300 MHz, and the BW of the output is centered at 300 MHz is approximately 95 MHz.
- b. The bandwidth in the microwave preselected bands increases approximately monotonically between the lowest and highest tuned frequencies. See “nominal Bandwidth” on page 295 of the PSA Specifications Guide.

## Regulatory Information

This product is designed for use in Installation Category II and Pollution Degree 2 per IEC 61010 2<sup>nd</sup> ed, and 664 respectively.

This product has been designed and tested in accordance with IEC Publication 61010 2<sup>nd</sup> ed, Safety Requirements for Electronic Measuring Apparatus, and has been supplied in a safe condition. The instruction documentation contains information and warnings which must be followed by the user to ensure safe operation and to maintain the product in a safe condition.

 ICES/NMB-001 ISM 1-A (GRP.1 CLASS A)	<p>The CE mark is a registered trademark of the European Community (if accompanied by a year, it is the year when the design was proven). This product complies with all relevant directives.</p> <p>“This ISM device complies with Canadian ICES-001.”</p> <p>“Cet appareil ISM est conforme a la norme NMB du Canada.”</p> <p>This is a symbol of an Industrial Scientific and Medical Group 1 Class A product. (CISPR 11, Clause 4)</p>
	<p>The CSA mark is the Canadian Standards Association. This product complies with the relevant safety requirements.</p>
	<p>The C-Tick mark is a registered trademark of the Australian/New Zealand Spectrum Management Agency. This product complies with the relevant EMC regulations.</p>
	<p><b>South Korean Class A EMC Declaration</b>                  A 급 기기 ( 업무용 방송통신기자재 )                  이 기기는 업무용 ( A 급 ) 전자파적합기기로서 판매자 또는 사용자는 이 점을 주의하시기 바라 며 , 가정외의 지역에서 사용하는 것을 목적으로 합니다 .</p> <p>This equipment is Class A suitable for professional use and is for use in electromagnetic environments outside of the home.</p>
	<p>This product complies with the WEEE Directive (2002/96/EC) marking requirements. The affixed label indicates that you must not discard this electrical/ electronic product in domestic household waste.</p> <p>Product Category: With reference to the equipment types in the WEEE Directive Annex I, this product is classed as a “Monitoring and Control instrumentation” product.</p> <p>Do not dispose in domestic household waste.</p> <p>To return unwanted products, contact your local Agilent office, or see <a href="http://www.agilent.com/environment/product/">www.agilent.com/environment/product/</a> for more information.</p>

## Declaration of Conformity

A copy of the Manufacturer’s European Declaration of Conformity for this instrument can be obtained by contacting your local Agilent Technologies sales representative.

## Compliance with German Noise Requirements

Acoustic Noise Emission/Geraeuschemission	
LpA <70 dB	LpA <70 dB
Operator position	Am Arbeitsplatz
Normal position	Normaler Betrieb
Per ISO 7779	Nach DIN 45635 t.19

## Compliance with EMC Requirements

Description	Specifications
<b>EMC</b>	<p>Complies with European EMC Directive 2004/108/EC</p> <p>IEC/EN 61326-1 or IEC/EN 61326-2-1</p> <p>CISPR Pub 11 Group 1, class A<sup>a</sup></p> <p>AS/NZS CISPR 11</p> <p>ICES/NMB-001</p> <p>This ISM devise complies with ICES-001. Cet appareil ISM est conforme a la norme NMB-001 du Canada.</p>

- a. The PSA is in full compliance with CISPR 11, Class A emissions and is declared as such. In addition, the PSA has been type tested and shown to meet CISPR 11, Class B emission limits. Information regarding the Class B emission performance of the PSA is provided as a convenience to the user and is not intended to be a regulatory declaration.

Description	Specifications
<b>Safety</b>	<p>Complies with European Low Voltage Directive 2006/95/EC</p> <p>IEC/EN 61010-1 2nd Edition</p> <p>Canada: CSA C22.2 No. 61010-1</p> <p>USA: UL 61010-1 2nd Edition 1</p>







---

## **2 Phase Noise Measurement Personality**

This chapter contains specifications for the PSA series, Option 226, Phase Noise measurement personality.

## Option 226, Phase Noise Measurement Personality

### Phase Noise

Description	Specifications	Supplemental Information
<b>Carrier Frequency Range</b>		
PSA Series Analyzers		
E4440A	1 MHz to 26.5 GHz	
E4443A	1 MHz to 6.7 GHz	
E4445A	1 MHz to 13.2 GHz	
E4446A	1 MHz to 44 GHz	
E4447A	1 MHz to 42.98 GHz	
E4448A	1 MHz to 50 GHz	

Description	Specifications	Supplemental Information
<b>Measurement Characteristics</b>		
Measurements	Log plot Spot frequency RMS noise RMS jitter Residual FM	
Maximum number of decades	7 (whole decades only)	
Filtering (ratio of video bandwidth to resolution bandwidth)	None (VBW/RBW = 1.0) Little (VBW/RBW = 0.3) Medium (VBW/RBW = 0.1) Maximum (VBW/RBW = 0.03)	

Description	Specifications	Supplemental Information
<b>Offset Frequency</b>  Range	10 Hz to 100 MHz	The minimum offset is limited to 10 times the narrowest RBW of the analyzer.

Description	Specifications	Supplemental Information
<b>Measurement Accuracy</b>  Amplitude Accuracy <sup>a</sup> (carrier frequency 1 MHz to 3.0 GHz)		±0.29 dB <sup>b</sup>

- a. Amplitude accuracy is derived from analyzer specification and characteristics. It is based on a 1 GHz signal at 0 dBm while running the log plot measurement with all other measurement and analyzer settings at their factory defaults.
- b. This does not include the effect of system noise floor. This error is a function of the signal (phase noise of the DUT) to noise (analyzer noise floor due to phase noise and thermal noise) ratio, SN, in decibels.

The function is:  $\text{error} = 10 \times \log(1 + 10^{-SN/10})$ .

For example, if the phase noise being measured is 10 dB above the measurement floor, the error due to adding the analyzer's noise to the UUT is 0.41 dB.

Phase Noise Measurement Personality  
**Option 226, Phase Noise Measurement Personality**

Description	Specifications	Supplemental Information			
<b>Amplitude Repeatability</b>		Standard Deviation <sup>a b</sup>			
		No Filtering <sup>c</sup>	Little Filtering	Medium Filtering	Maximum Filtering
	No Smoothing				
	Offset				
	100 Hz	5.4 dB	3.4 dB	3.9 dB	3.4 dB
	1 kHz	5.2 dB	3.7 dB	2.3 dB	2.1 dB
	10 kHz	5.1 dB	3.5 dB	2.0 dB	1.2 dB
	100 kHz	4.5 dB	2.9 dB	1.9 dB	1.0 dB
	1 MHz	4.1 dB	2.7 dB	1.7 dB	0.95 dB
	4 % Smoothing <sup>d</sup>				
	Offset				
	100 Hz	1.7 dB	1.1 dB	1.1 dB	0.88 dB
	1 kHz	1.3 dB	0.78 dB	0.53 dB	0.37 dB
	10 kHz	1.1 dB	0.78 dB	0.34 dB	0.29 dB
100 kHz	0.86 dB	0.40 dB	0.40 dB	0.23 dB	
1 MHz	0.34 dB	0.32 dB	0.16 dB	0.11 dB	

- a. Amplitude repeatability is the nominal standard deviation of the measured phase noise. This table comes from an observation of 30 log plot measurements using a 1 GHz, 0 dBm signal with the filtering and smoothing settings shown. All other analyzer and measurement settings are set to their factory defaults.
- b. The standard deviation can be further reduced by applying averaging. The standard deviation will improve by a factor of the square root of the number of averages. For example, 10 averages will improve the standard deviation by a factor of 3.2.
- c. When, using the filtering setting of "None", it is important to increase the number of averages to acquire sufficient data to give accurate results. When not using any averaging and setting the filtering to "None", an under response of -2.5 dB will occur. As long as enough averaging is used, either by increasing the number of averages or using the default filtering setting of "Medium", the effect of the choice of filtering becomes irrelevant.
- d. Smoothing can cause additional amplitude errors near rapid transitions of the data, such as with discrete spurious signals and impulsive noise. The effect is more pronounced as the number of points smoothed increases.

Description	Specifications	Supplemental Information
<b>Frequency Offset Accuracy<sup>a</sup></b>	$\pm 1.4\%$	0.02 octave

- a. The frequency offset error in octaves causes an additional amplitude accuracy error proportional to the product of the frequency error and slope of the phase noise. For example, a 0.01 octave frequency error combined with an 18 dB/octave slope gives 0.18 dB additional amplitude error.

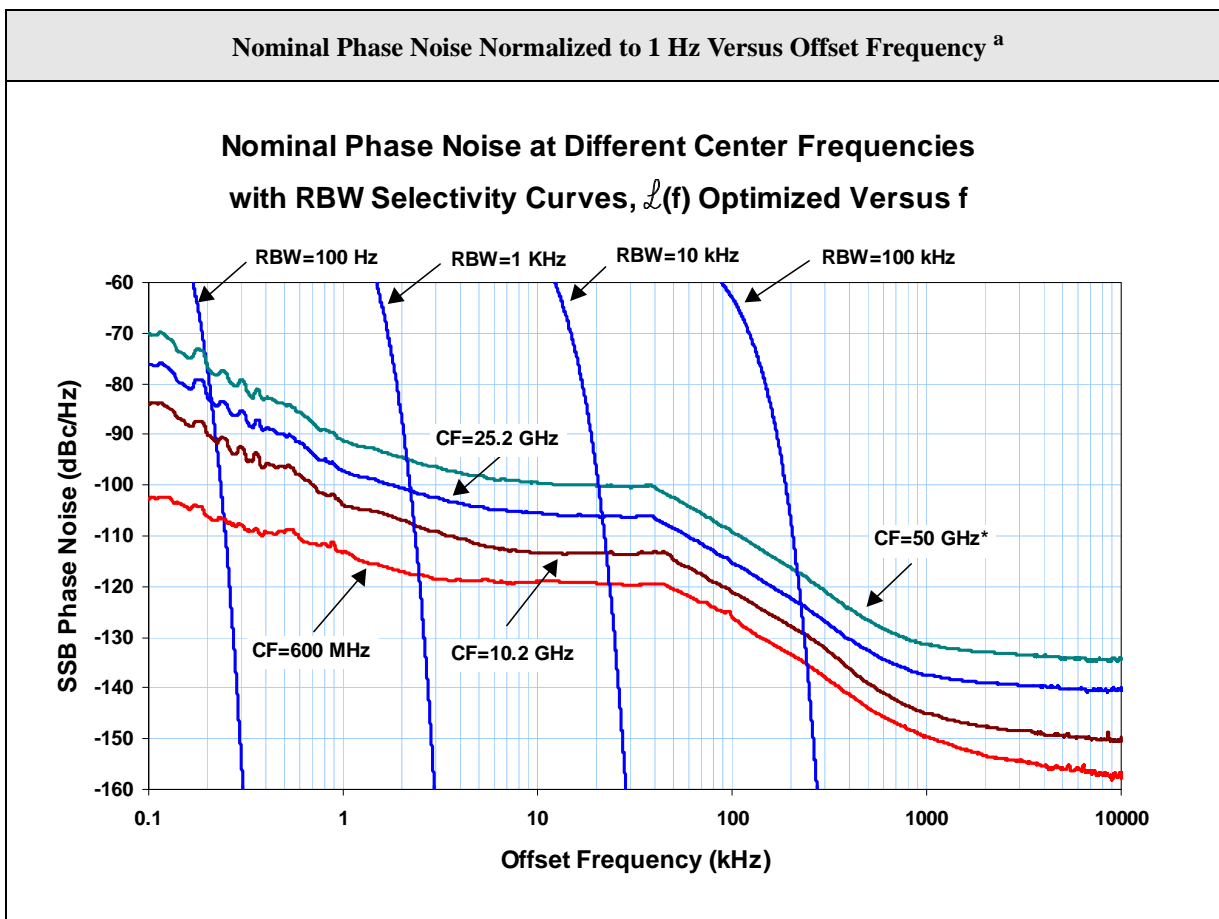

- a. Unlike the other curves, which are measured results from the measurement of excellent sources, the CF = 50 GHz curve is the predicted, not observed, phase noise, computed from the 25.2 GHz observation. See the footnotes in the Frequency Stability section in the Frequency chapter for the details of phase noise performance versus center frequency.

Phase Noise Measurement Personality  
**Option 226, Phase Noise Measurement Personality**

---

## **3 Noise Figure Measurement Personality**

This chapter contains specifications for the PSA series, Option 219, Noise Figure Measurement Personality.

## Option 219, Noise Figure Measurement Personality

Description	Specifications	Supplemental Information
<b>Noise Figure</b>		Uncertainty Calculator <sup>a</sup>
200 kHz to 10 MHz <sup>b</sup>		Using internal preamp ( <i>Option 1DS</i> )
Noise Source ENR		Measurement Range (nominal)      Instrument Uncertainty <sup>a</sup> (nominal)
4 – 7 dB		0 – 20 dB      ±0.05 dB
12 – 17 dB		0 – 30 dB      ±0.05 dB
20 – 22 dB		0 – 35 dB      ±0.10 dB
10 to 30 MHz		Using internal preamp ( <i>Option 110</i> )
Noise Source ENR		Measurement Range (nominal)      Instrument Uncertainty <sup>a</sup> (nominal)
4 – 7 dB		0 – 20 dB      ±0.05 dB
12 – 17 dB		0 – 30 dB      ±0.05 dB
20 – 22 dB		0 – 35 dB      ±0.10 dB
10 MHz to 3 GHz		Using internal preamp ( <i>Option 1DS</i> ), and RBW=1 MHz

- a. The figures given in the table are for the uncertainty added by the PSA instrument only. To compute the total uncertainty for your noise figure measurement, you need to take into account other factors including: DUT NF, Gain, Gain Uncertainty and Match; Noise source ENR uncertainty and Match. The computations can be performed with the uncertainty calculator included with the Noise Figure Measurement Personality. Go to Mode Setup then select Uncertainty Calculator. Similar calculators are also available on the Agilent web site; go to <http://www.agilent.com/find/nfu>.
- b. See the FAQ for current information on the availability of noise sources for this frequency range. To find the FAQ, choose any PSA Series model number from [www.agilent.com/find/psa](http://www.agilent.com/find/psa), and look for the FAQ link under “In the Library”.



Description	Specifications		Supplemental Information
Noise Source ENR	Measurement Range	Instrument Uncertainty <sup>a</sup>	Using internal preamp (Option 110) and RBW=1 MHz
4 – 7 dB	0 – 20 dB	±0.05 dB	
12 – 17 dB	0 – 30 dB	±0.05 dB	
20 – 22 dB	0 – 35 dB	±0.10 dB	
30 MHz to 3 GHz			
Noise Source ENR	Measurement Range	Instrument Uncertainty <sup>a</sup>	
4 – 7 dB	0 – 20 dB	±0.05 dB	
12 – 17 dB	0 – 30 dB	±0.05 dB	
20 – 22 dB	0 – 35 dB	±0.10 dB	

- a. “Instrument Uncertainty” is defined for noise figure analysis as uncertainty due to relative amplitude uncertainties encountered in the analyzer when making the measurements required for a noise figure or gain computation. The relative amplitude uncertainty is given by the relative display scale fidelity, also known as incremental log fidelity. The uncertainty of the analyzer is multiplied within the computation by an amount that depends on the Y factor to give the total uncertainty of the noise figure or gain measurement.

See Agilent App Note 57-2, literature number 5952-3706E for details on the use of this specification. Jitter (amplitude variations) will also affect the accuracy of results. The standard deviation of the measured result decreases by a factor of the square root of the Resolution Bandwidth used and by the square root of the number of averages. PSA uses the 1 MHz resolution Bandwidth as default since this is the widest bandwidth with uncompromised accuracy.

Noise Figure Measurement Personality  
Option 219, Noise Figure Measurement Personality

Description	Specifications	Supplemental Information
3 to 26.5 GHz <sup>a</sup>  Instrument Uncertainty  3 to 10 GHz  10 to 20 GHz  20 to 26.5 GHz		No internal preamp  Nominally the same as for the 10 MHz to 3 GHz range;  External preamp caution <sup>b</sup>  Well-controlled preselector <sup>c</sup>  Good preselector stability <sup>d</sup>  Preselector Drift Effects <sup>e</sup>

- a. For this frequency range, the Instrument Noise Figure Uncertainty is still well controlled, but other accuracy issues become critical. Because there is no internal preamplifier in this range, the Instrument Noise Figure is much higher than in the range below 3 GHz. This causes the effect on total measurement Noise Figure Uncertainty of the Instrument Gain Uncertainty to be much higher, and that Instrument Gain Uncertainty is in turn much higher than in the range below 3 GHz because of the effects of the preselector, explained in subsequent footnotes. As a result, when the DUT has high gain, the total measurement Noise Figure Uncertainty computed with the Uncertainty Calculator can still be excellent, but modest and low gain devices can have very high uncertainties of noise figure. Graphs that follow demonstrate. The first graph shows the error in NF with no preamp, and shows how much gain is required to achieve good accuracy. The second graph shows NF Error when using an external preamp with 23 dB gain and 6 dB NF.
- b. An external preamp can reduce the total NF measurement uncertainty substantially because it will reduce the effective noise figure of the measurement system, and thus it will reduce the sensitivity of the total NF uncertainty to the Instrument Gain Uncertainty. But if the signal levels into such an external preamp are large enough, that external preamp may experience some compression. The compression differences between the noise-source-on and noise-source-off states causes an error that must be added to Instrument Noise Figure Uncertainty for use in the Noise Figure Uncertainty Calculator. Such signal levels are quite likely for the case where the DUT has some combination of high gain, high noise figure and wide bandwidth.  
 As an example, we will use the Agilent 83006A as the external preamplifier. The measurement will be made at 18 GHz. The typical gain is 25 dB and the noise figure is 7 dB. We will assume the DUT has 20 dB gain, a 10 dB NF, and a passband from 5 to 30 GHz. We will use a noise source with 17 dB ENR. When the noise source is on, the DUT output can be computed by starting with  $kTB$  ( $-174$  dBm/Hz) and adding  $10 \times \log(30 \text{ GHz} - 5 \text{ GHz})$  or 104 dB, giving  $-70$  dBm for the thermal noise. Add to this the ENR of the noise source (17 dB) combined with the NF of the DUT (10 dB) to give an equivalent input ENR of 18 dB, thus  $-52$  dBm input noise power. Add the gain of the DUT (20 dB) to find the DUT output power to be  $-32$  dBm. The noise figure of the external preamp may be neglected. The external preamplifier gain of 25 dB adds, giving a preamplifier output power of  $-7$  dBm. The typical 1 dB compression point of this amplifier is +19 dBm. Therefore, the output noise is 26 dB below the 1 dB compression point. This amplifier will have negligible compression.  
 As a rule of thumb, the compression of a noise signal is under 0.1 dB if the average noise power is kept 7 dB below the 1 dB CW compression point. The compression in decibels will usually double for every 3 dB increase in noise power. Use cases with higher gain DUTs or preamplifiers with lower output power capability could be compressed, leading to additional errors.
- c. In this frequency range, the preselector is well-controlled and there should be no need for special measurement techniques.

- d. In this frequency range, the preselector usually requires no special measurement techniques in a lab environment. But if the temperature changes by a few degrees, or the analyzer frequency is swept or changed across many gigahertz, there is a small risk that the preselector will not be centered well enough for good measurements.
- e. In this frequency range, the preselector behavior is not warranted. There is a modest risk that the preselector will not be centered well enough for good measurements. This risk may be reduced but not eliminated by using the analyzer at room temperature, limiting the span swept to a few gigahertz, and not changing the operating frequency range for many minutes.

Noise Figure Measurement Personality  
**Option 219, Noise Figure Measurement Personality**

Description	Specifications	Supplemental Information
3 to 26.5 GHz		Using internal preamp (Option 110)
Instrument Uncertainty		Nominally the same as for the 30 MHz to 3 GHz range
3 to 10 GHz		Well-controlled preselector <sup>a</sup>
10 to 20 GHz		Good preselector stability <sup>b</sup>
20 to 26.5 GHz		Preselector Drift Effects <sup>c</sup>
26.5 to 50 GHz		Instrument Uncertainty <sup>d</sup>

- a. In this frequency range, the preselector is well-controlled and there should be no need for special measurement techniques.
- b. In this frequency range, the preselector usually requires no special measurement techniques in a lab environment. But if the temperature changes by a few degrees, or the analyzer frequency is swept or changed across many gigahertz, there is a small risk that the preselector will not be centered well enough for good measurements.
- c. In this frequency range, the preselector behavior is not warranted. There is a modest risk that the preselector will not be centered well enough for good measurements. This risk may be reduced but not eliminated by using the analyzer at room temperature, limiting the span swept to a few gigahertz, and not changing the operating frequency range for many minutes.
- d. The Instrument Uncertainty performance, itself, becomes less significant in these frequency regions when other factors such as Instrument Noise Figure (see graphs for E4448A w/Option 110) tend to dominate the accuracy of the measurement. However, effective noise figure and gain measurements are still achievable, especially when the DUT has reasonably high gain. In order to mitigate the effect of increased instrument noise figure, techniques such as averaging (see the footnote on “[Instrument Uncertainty](#)” on page 121) and utilization of higher ENR sources, can be used. However, care must be taken to avoid signal levels that lead to compression.

**Computed Measurement NF Uncertainty vs. DUT Gain,  
 >3 GHz Non-warranted Frequency Range, No Internal Preamplifier**

Assumptions: Measurement Frequency 12 GHz, Instrument NF = 26.5 dB, Instrument VSWR = 1.4, Instrument Gain Uncertainty = 2.2 dB, Instrument NF Uncertainty = 0.05 dB, Agilent 346B Noise Source with Uncertainty = 0.2 dB, Source VSWR = 1.25, DUT input/output VSWR = 1.5.

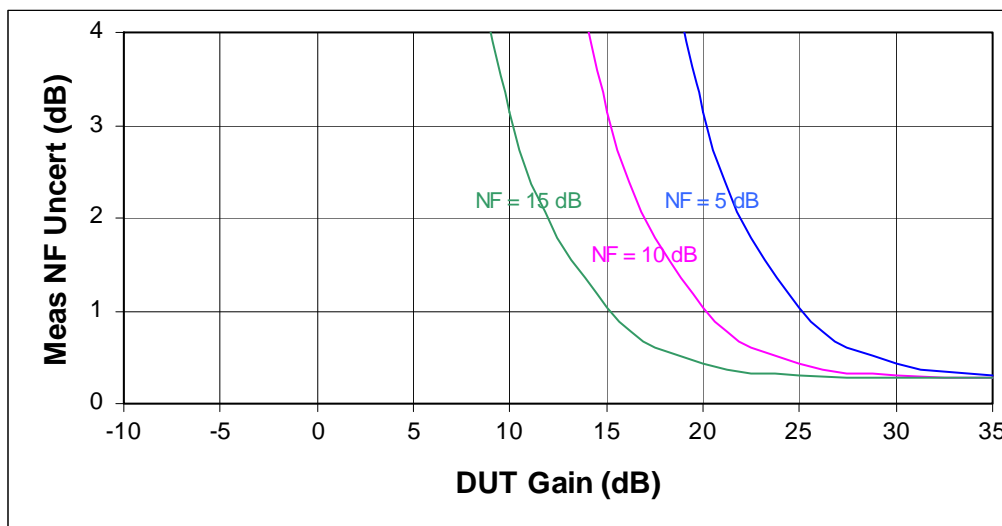

**Computed Measurement NF Uncertainty vs. DUT Gain,  
 >3 GHz Non-warranted Frequency Range, No Internal Preamplifier**

Assumptions: Same as above, with the addition of an external preamp. With an external preamp, the preamp/analyzer combination NF is 7.93 dB; the external preamp alone has a gain of 23 dB and a NF of 6 dB. Instrument VSWR is now that of the external preamp; VSWR = 2.6.

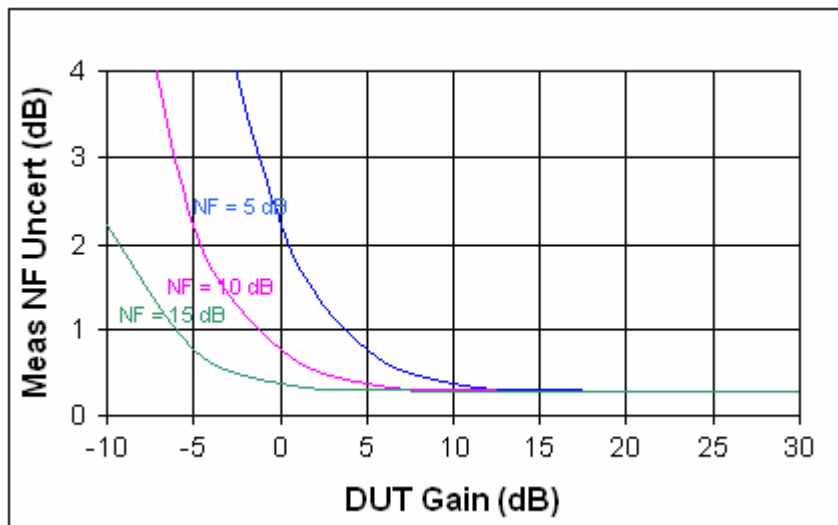

Noise Figure Measurement Personality  
**Option 219, Noise Figure Measurement Personality**

Description	Specifications		Supplemental Information
<b>Gain</b>			
200 kHz to 10 MHz <sup>a</sup>			Using internal preamp ( <i>Option IDS</i> )
Noise Source ENR			Measurement Range (nominal)      Instrument Uncertainty <sup>b</sup> (nominal)
4 – 7 dB			–20 to 40 dB      ±0.17 dB
12 – 17 dB			–20 to 40 dB      ±0.17 dB
20 – 22 dB			–20 to 40 dB      ±0.17 dB
10 MHz to 3 GHz			Using internal preamp ( <i>Option IDS</i> )
Noise Source ENR	Measurement Range	Instrument Uncertainty <sup>b</sup>	
4.5 – 6.5 dB	–20 to 40 dB	±0.17 dB	
12 – 17 dB	–20 to 40 dB	±0.17 dB	
20 – 22 dB	–20 to 40 dB	±0.17 dB	
30 MHz to 3 GHz			Using internal preamp ( <i>Option I10</i> )
Noise Source ENR	Measurement Range	Instrument Uncertainty <sup>b</sup>	
4.5 – 6.5 dB	–20 to 40 dB	±0.17 dB	
12 – 17 dB	–20 to 40 dB	±0.17 dB	
20 – 22 dB	–20 to 40 dB	±0.17 dB	
3 to 26.5 GHz <sup>c</sup>			
Instrument Uncertainty			±2.2 dB (nominal) <sup>d</sup> for Measurement Range –20 to 40 dB
26.5 to 50 GHz			See the uncertainty footnote on <a href="#">page 122</a> .

- a. See the FAQ for current information on the availability of noise sources for this frequency range. To find the FAQ, choose any PSA Series model number from [www.agilent.com/find/psa](http://www.agilent.com/find/psa), and look for the FAQ link under “In the Library.”
- b. See the “Instrument Uncertainty” footnote [a](#) on [page 122](#)

- c. See footnotes [b](#), [c](#), [d](#) and [e](#) for this frequency range in the Noise Figure section on [page 122](#)
- d. The performance shown would apply when there is a long time between the calibration step and the DUT-measurement step in a NF or Gain measurement. Under special circumstances of small changes in frequency (such as spot frequency measurements) and short time periods between the calibration time and the measurement time, this error source becomes much smaller, approaching the Instrument Uncertainty shown for the 10 MHz to 3 GHz frequency range. These special circumstances would be frequency span ranges of under 1 GHz, with that frequency range unchanged for 30 minutes, and the time between the calibration step and the DUT measurement step held to less than 10 minutes.

Description	Specifications	Supplemental Information
<b>Noise Figure Uncertainty Calculator<sup>a</sup></b>		
Noise Figure Instrument Uncertainty	See Noise Figure	
Gain Instrument Uncertainty	See Gain	
Instrument Noise Figure		See graphs, Nominal Noise Figure DANL +176.15, nominal <sup>b</sup>
Instrument Input Match		See graphs, Nominal VSWR

- a. Noise figure uncertainty calculations require the parameters shown in order to calculate the uncertainty.
- b. Nominally, the noise figure of the spectrum analyzer is given by the DANL (displayed average noise level) minus  $kTB$  ( $-173.88$  dB in a 1 Hz bandwidth at  $25$  °C) plus  $2.51$  dB (the effect of log averaging used in DANL verifications) minus  $0.24$  dB (the ratio of the noise bandwidth of the 1 Hz RBW filter with which DANL is specified to a 1 Hz noise bandwidth for which  $kTB$  is given). The actual NF will vary from the nominal due to frequency response errors.

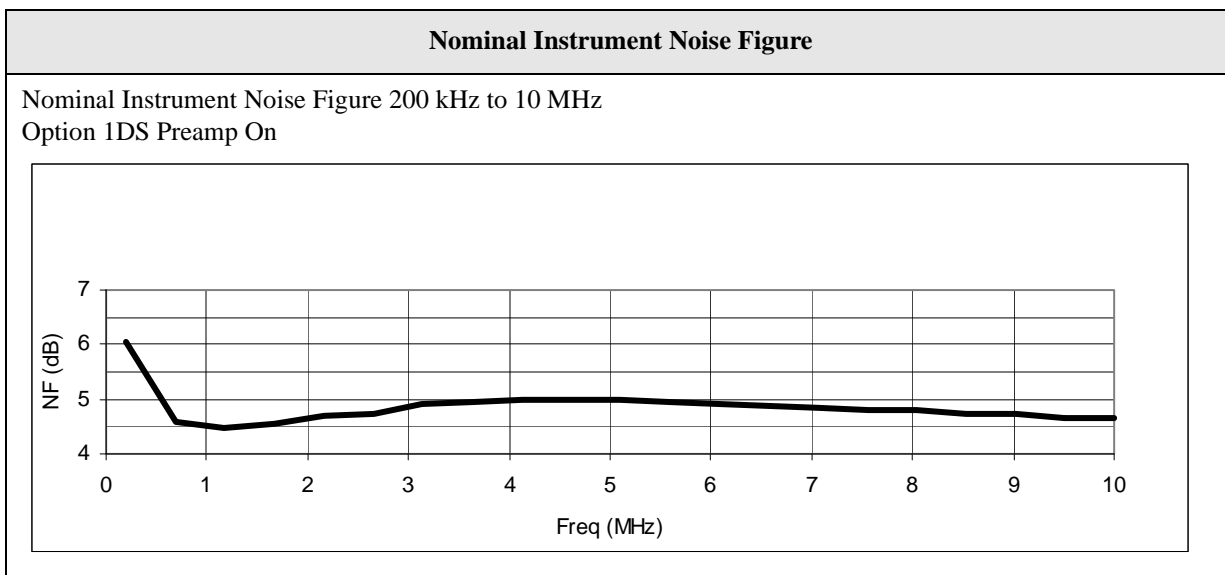

Noise Figure Measurement Personality  
Option 219, Noise Figure Measurement Personality

Nominal Instrument Noise Figure

Nominal Instrument Noise Figure 10 MHz to 3 GHz  
Option 1DS Preamp On

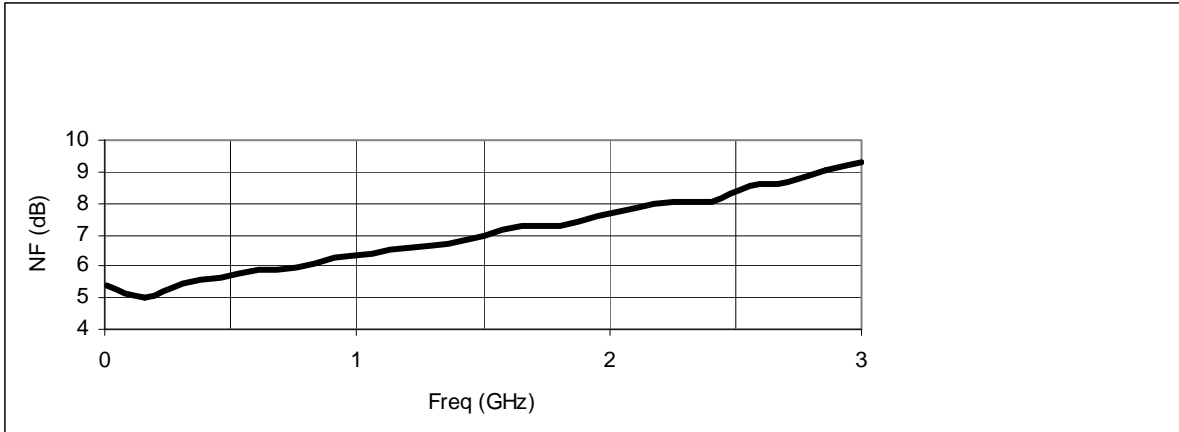

Nominal Instrument Noise Figure

Nominal Instrument Noise Figure 10 MHz to 3 GHz  
Option 110 Preamp On

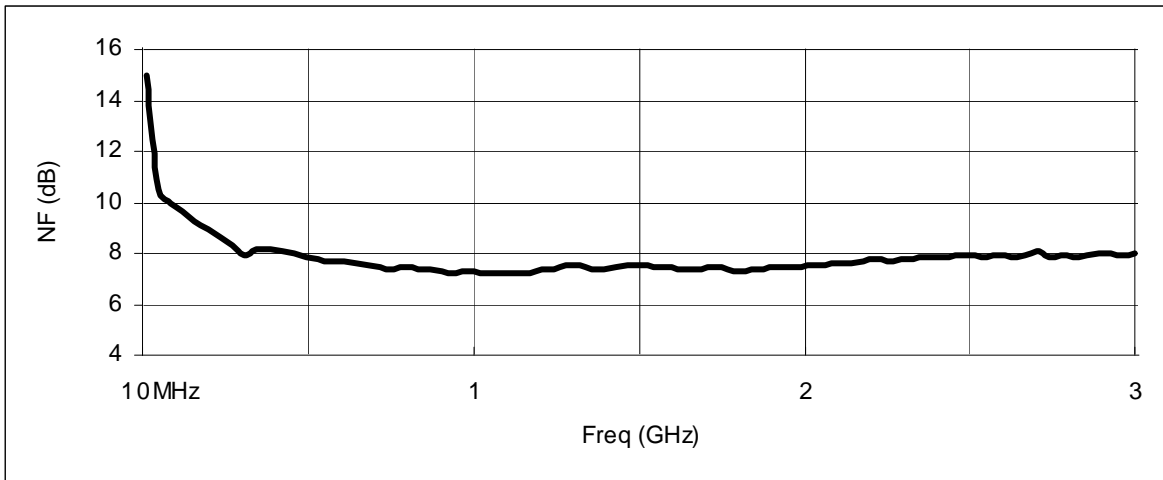



Nominal Instrument Noise Figure

Nominal Instrument Noise Figure 3 to 26.5 GHz  
No Preamp

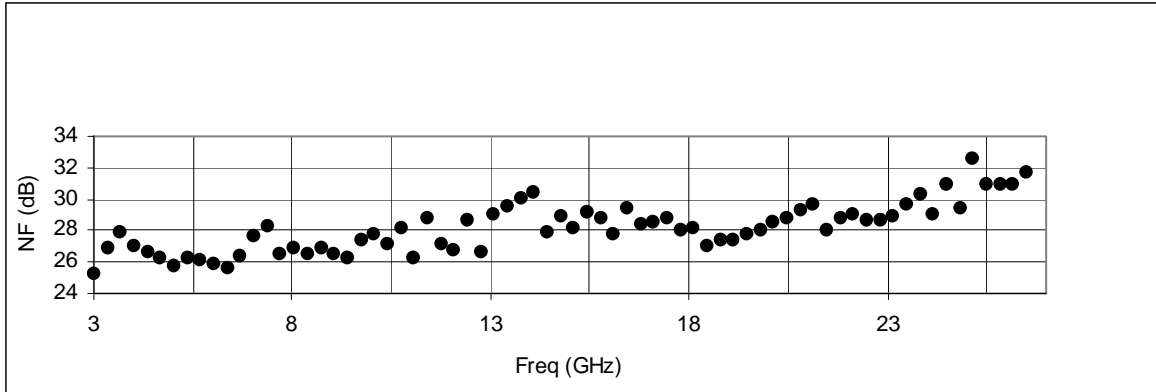

Nominal Instrument Noise Figure

Nominal Instrument Noise Figure 3 to 50 GHz  
Option 110 Preamp On

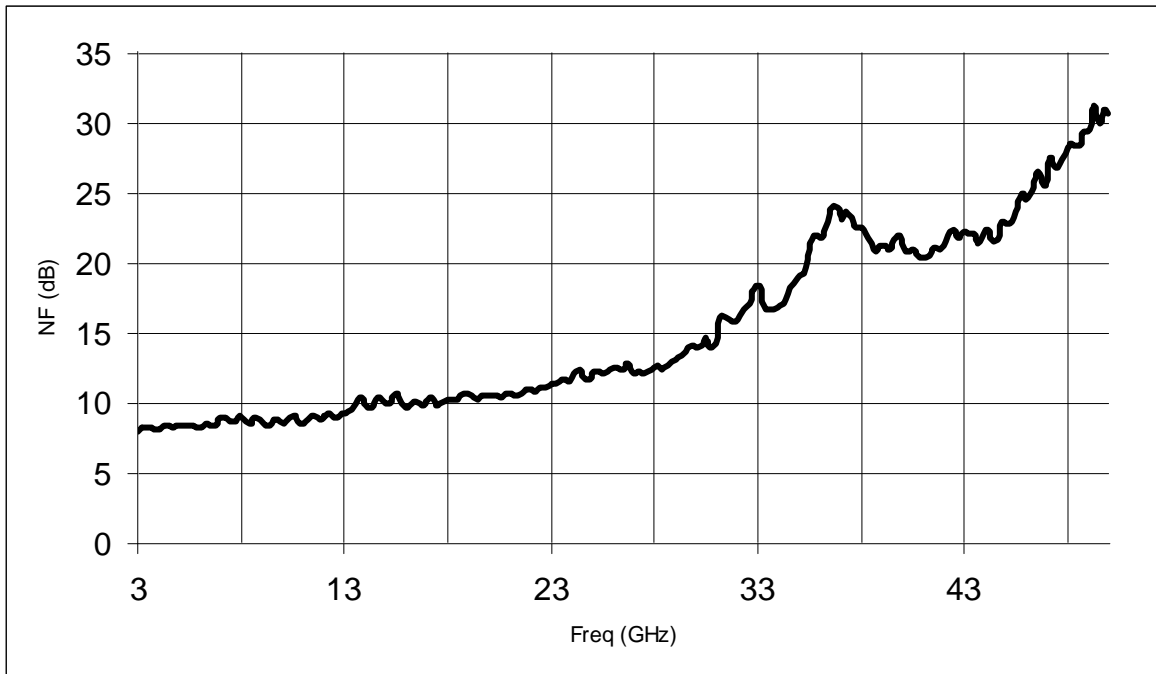

Noise Figure Measurement Personality  
Option 219, Noise Figure Measurement Personality

Nominal Instrument Noise Figure

Nominal Instrument Input VSWR 200 kHz to 10 MHz; Preamp 1DS On, Attenuation = 0 dB  
VSWR of two instruments shown. One was an E4440A and one was an E4448A (bold trace). All PSA models have similar VSWR behavior in this frequency range.

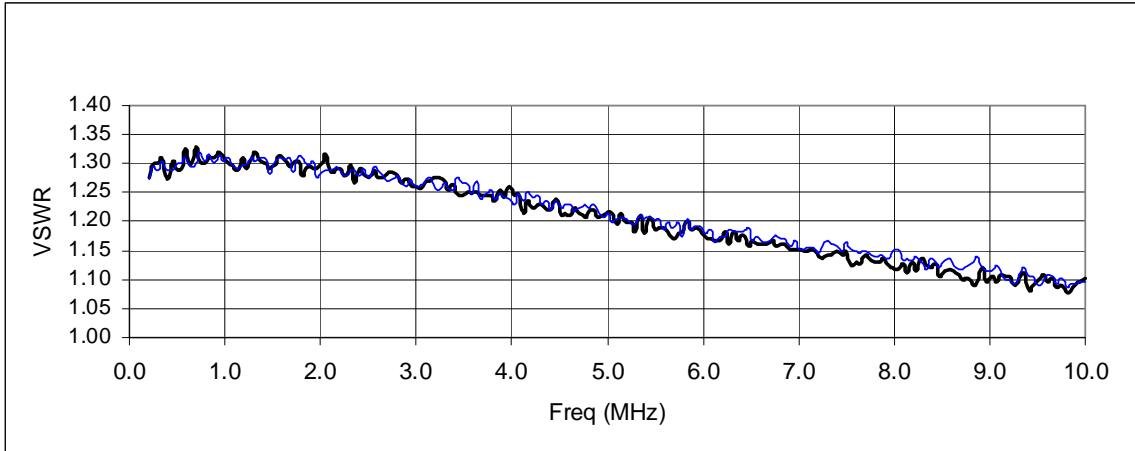

Nominal Instrument Noise Figure

Nominal Instrument Input VSWR 10 MHz to 3 GHz; Preamp 1DS On, Attenuation = 0 dB  
VSWR of six instruments shown. Three graphs are representative of E4440/3/5 models, and three of E4446/8 models (bold traces).

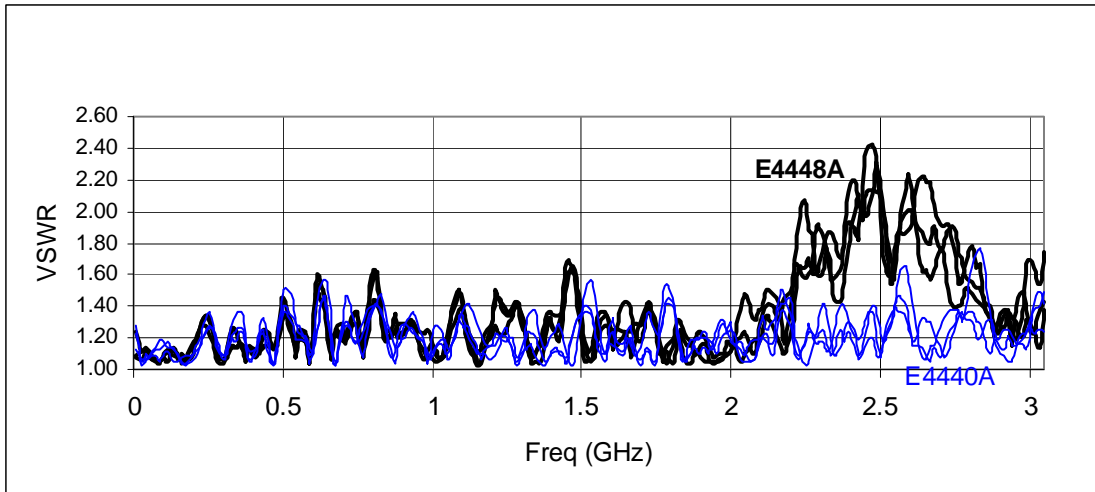

Nominal Instrument Noise Figure

Nominal Instrument Input VSWR 10 MHz to 3 GHz; Option 110 Preamp On, Attenuation = 0 dB  
VSWR of one E4448A.

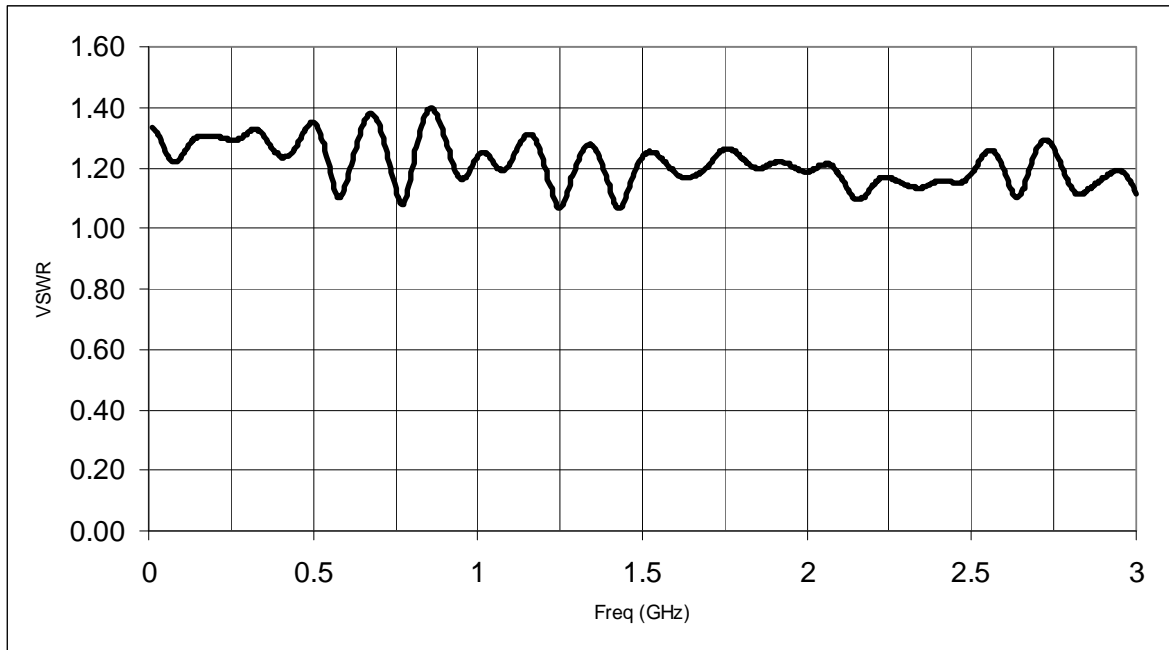

Noise Figure Measurement Personality  
Option 219, Noise Figure Measurement Personality

Nominal Instrument Input VSWR

Nominal Instrument Input VSWR 3 to 26.5 GHz; No Preamp, Attenuation = 0 dB  
VSWR of six instruments shown. Three graphs are representative of E4440/3/5 models, and three of E4446/8 models (bold traces).

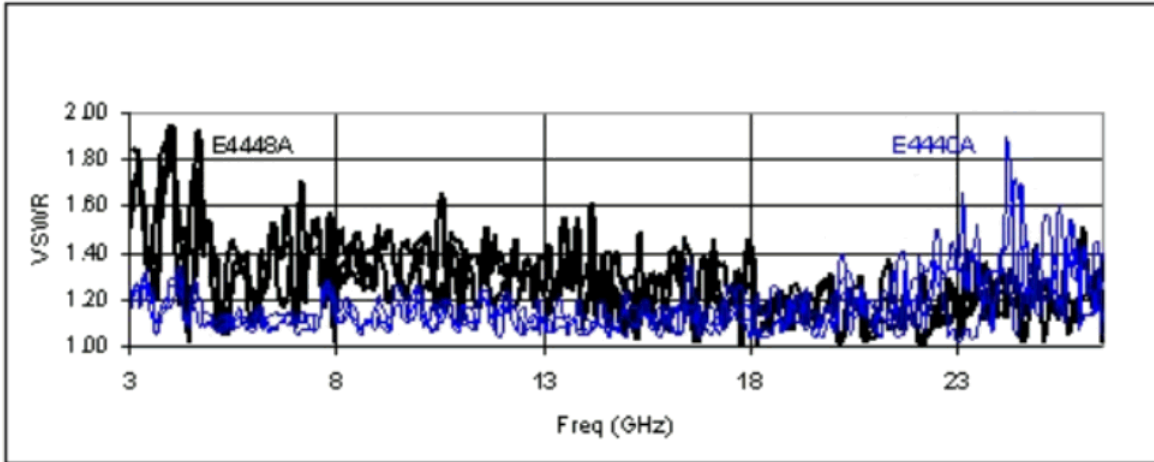

Nominal Instrument Input VSWR 3 to 50 GHz; Option 110 Preamp On, Attenuation = 0 dB  
VSWR of E4448A

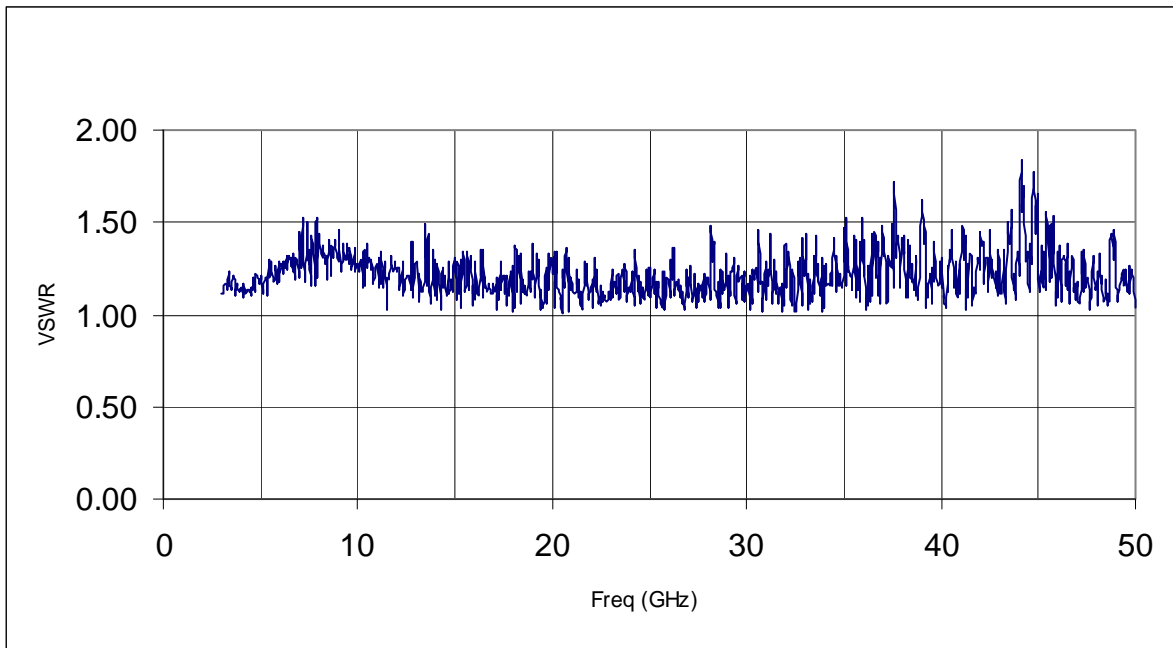



### Additional Definitions and Requirements

Because digital communications signals are noise-like, all measurements will have variations. The specifications apply only with adequate averaging to remove those variations.

The specifications apply in the frequency ranges documented in In-Band Frequency Range.

The specifications for this chapter apply to the E4440A, E4443A, and E4445A spectrum analyzers. For the E4446A, E4447A, and E4448A, the performance is nominal only and not subject to any warranted specifications.

The measurement performance is only slightly different in the E4446A, E4447A, and E4448A when compared to the performance of the E4440A, E4443A, and E4445A analyzers. Because the hardware performance of the analyzers is very similar, but not identical, you can estimate the nominal performance of the measurements from the specifications in this chapter.

Description	Specifications	Supplemental Information
<p><b>Signal Acquisition</b></p> <p>Frequency Range <sup>a</sup></p> <p>Operational range</p>	<p>3 Hz to 6.7 GHz</p> <p>3 Hz to 13.2 GHz</p> <p>3 Hz to 26.5 GHz</p> <p>3 Hz to 42.98 GHz</p> <p>3 Hz to 44 GHz</p> <p>3 Hz to 50 GHz</p>	<p>E4443A</p> <p>E4445A</p> <p>E4440A</p> <p>E4447A</p> <p>E4446A</p> <p>E4448A</p>

a. Specified range is the frequency range over which all specifications apply. Operational range is the frequency range over which the personality may be operated, subject to the maximum frequency for each PSA model.

Description	Specifications	Supplemental Information
Analysis bandwidth Without options 122 or 140/123 <sup>a</sup> Range (IFBW) IF Frequency response, FBW = 10 MHz IF Frequency response, FBW = 6.4 MHz	1 kHz to 10 MHz	Flat Top ±0.12 dB (nominal) 1 × peak-to-peak (nominal)
With options 122/123 <sup>a</sup> Range (IFBW) IF Frequency Response Phase Linearity	1 kHz to 80 MHz	Flat Top Refer to <a href="#">page 273</a> . Refer to <a href="#">page 275</a> .
With options 140/123 <sup>b</sup> Range (IFBW) IF Frequency Response Phase Linearity	1 kHz to 40 MHz	Flat Top Refer to <a href="#">page 296</a> . Refer to <a href="#">page 298</a> .
Data block length	10 to 20000 symbols	Variable based on samples per symbol
Samples per symbol	1, 2, 4, 5 or 10 <sup>c</sup>	
Symbol clock	Internally generated	

- a. For wideband modulation analysis up to 80 MHz, option 123 is necessary to get maximum performance out of option 122 at frequencies above 3.05 GHz.
- b. For wideband modulation analysis up to 40 MHz, option 123 is necessary to get maximum performance out of option 140 at frequencies above 3.05 GHz.
- c. 2, 4 or 10 when Modulation Format is set to OQPSK





Description	Specifications	Supplemental Information
<b>Trigger</b>		
Source	Free Run (immediate), Video (IF envelope), RF Burst (IF wideband), Ext Front, Ext Rear, Frame	
Trigger delay Range Repeatability	-100 ms to +500 ms ±33 ns	For Video, RF Burst, Ext Front, Ext Rear
Trigger slope	Positive, Negative	
Trigger hold off Range Resolution	0 to 500 ms 1 µs	
Auto trigger Time interval range	On, Off	0 to 10 s (nominal) Does an immediate trigger if no trigger occurs before the set time interval.
RF burst trigger Peak carrier power range at RF Input	+27 dBm to -40 dBm	IF Wideband for repetitive burst signals.
Trigger level range	0 to -25 dB	Relative to signal peak
Bandwidth		>15 MHz (nominal)
Video (IF envelope) trigger Range	+30 dBm to noise floor	
Measurement Control	Single, Continuous, Restart, Pause, Resume	
Data synchronization		User-selected synchronization words



Description	Specifications	Supplemental Information
<p><b>Filtering</b></p> <p>Measurement filter types</p> <p>Reference filter types</p> <p>User-selectable Alpha/BT</p> <p>Range</p> <p>Resolution</p>	<p>Nyquist (Raised cosine), Root Nyquist (Square-root raised cosine), IS-95 compatible, Gaussian, EMF (EDGE), Rectangle, None</p> <p>Nyquist (Raised cosine), Root Nyquist (Square-root raised cosine), IS-95 compatible, Gaussian, EDGE, Rectangle, Half sine</p> <p>0.01 to 1.0</p> <p>0.01</p>	

Description	Specifications	Supplemental Information
<p><b>Symbol rate</b></p> <p>Range</p> <p>IFBW = Narrow</p> <p>IFBW = Wide, with options 122/123</p> <p>IFBW = Wide, with options 140/123</p> <p>Maximum symbol rate</p>		<p>1 kHz to 10 MHz<sup>a</sup> (nominal)</p> <p>10 kHz to 80 MHz<sup>a</sup> (nominal)</p> <p>10 kHz to 40 MHz (nominal)</p> <p>IFBW / (1+ <math>\alpha</math>)<sup>b</sup></p>

- a. Meaningful operational range is limited by the Maximum symbol rate. For the optimum EVM accuracy, the analysis bandwidth (IFBW) should encompass all the significant power spectral density of the signal.
- b. Determined by the IFBW and the excess bandwidth factor ( $\alpha$ ) of the input signal. The entire signal must fit within the selected IFBW.

Description	Specifications		Supplemental Information	
<b>Accuracy<sup>a</sup></b> BPSK, QPSK, 8PSK, DQPSK, D8PSK, $\pi/4$ DQPSK <sup>b</sup> Symbol rate $\geq 1$ kHz			Frequency range < 3GHz	
Residual errors	$\geq 0.3$	$0.2 \leq \alpha < 0.3$	$\alpha \geq 0.3$ (typical)	$0.2 \leq \alpha < 0.3$ (typical)
Error vector magnitude (EVM)				
Symbol rate < 10 kHz	0.8 % rms	0.9 % rms	0.7 % rms	0.7 % rms
Symbol rate < 100 kHz	0.7 % rms	0.7 % rms	0.6 % rms	0.6 % rms
Symbol rate < 1 MHz	0.9 % rms	0.9 % rms	0.6 % rms	0.7 % rms
Symbol rate < 6 MHz	2.1 % rms	2.1 % rms	1.2 % rms	1.2 % rms
Magnitude error				
Symbol rate < 10 kHz	0.4 % rms	0.5 % rms	0.4 % rms	0.5 % rms
Symbol rate < 100 kHz	0.4 % rms	0.5 % rms	0.4 % rms	0.5 % rms
Symbol rate < 1 MHz	0.5 % rms	0.6 % rms	0.4 % rms	0.5 % rms
Symbol rate < 6 MHz	1.5 % rms	1.5 % rms	0.8 % rms	0.8 % rms
Phase error <sup>c</sup>				
Symbol rate < 10 kHz	0.5 % rms	0.5 % rms	0.4 % rms	0.4 % rms
Symbol rate < 100 kHz	0.4 % rms	0.4 % rms	0.3 % rms	0.3 % rms
Symbol rate < 1 MHz	0.5 % rms	0.5 % rms	0.3 % rms	0.3 % rms
Symbol rate < 6 MHz	1.2 % rms	1.2 % rms	0.7 % rms	0.7 % rms
Frequency error			$\pm$ Symbol rate/500,000 + tfa <sup>d</sup> (nominal)	
I-Q origin offset				
Analyzer Noise Floor			-60 dB (nominal)	

- These specifications apply for signals without an Input Overload message, with (RF input power – Input Atten)  $\geq -25$  dBm, random data sequence, and temperature 20 to 30 °C, Equalization filter Off
- Meas Filter = Root Nyquist, Ref Filter = Nyquist, Results length = 150 symbols
- For modulation formats with equal symbol amplitudes.
- tfa = transmitter frequency  $\times$  frequency reference accuracy

Description	Specifications		Supplemental Information	
16QAM, 32QAM, 64QAM, 128QAM, 256QAM <sup>a</sup> Symbol rate >= 10 kHz			Frequency range < 3GHz	
Residual errors	$0.2 \leq \alpha \leq 0.3$	$0.1 \leq \alpha < 0.2$	$0.2 \leq \alpha \leq 0.3$ (typical)	$0.1 \leq \alpha < 0.2$ (typical)
Error vector magnitude (EVM)				
Symbol rate < 100 kHz	0.7 % rms	0.9 % rms	0.6 % rms	0.8 % rms
Symbol rate < 1 MHz	0.8 % rms	1.0 % rms	0.6 % rms	0.9 % rms
Symbol rate < 6 MHz	2.1 % rms	2.7 % rms	1.2 % rms	1.3 % rms
Magnitude error				
Symbol rate < 100 kHz	0.3 % rms	0.5 % rms	0.2 % rms	0.5 % rms
Symbol rate < 1 MHz	0.5 % rms	0.7 % rms	0.4 % rms	0.6 % rms
Symbol rate < 6 MHz	1.5 % rms	2.0 % rms	0.9 % rms	0.9 % rms
Phase error				
Symbol rate < 100 kHz	0.4 % rms	0.6 % rms	0.3 % rms	0.6 % rms
Symbol rate < 1 MHz	0.6 % rms	0.7 % rms	0.4 % rms	0.6 % rms
Symbol rate < 6 MHz	1.5 % rms	1.8 % rms	0.9 % rms	0.9 % rms
Frequency error			$\pm$ Symbol rate/500,000 + tfa <sup>b</sup> (nominal)	
I-Q origin offset				
Analyzer Noise Floor			-60 dB (nominal)	
MSK <sup>c</sup> Symbol rate = 200 to 300 kHz BT = 0.3			Frequency range < 3GHz	
Residual errors				
Phase error	0.3 % rms			
Frequency error	$\pm 5$ Hz + tfa <sup>b</sup>			
I-Q origin offset			-60 dB (nominal)	

- a. Meas Filter = Root Nyquist, Ref Filter = Nyquist, Results length = 800 symbols, EVM Ref Calc = RMS
- b. tfa = transmitter frequency × frequency reference accuracy
- c. Meas Filter = none, Ref Filter = Gaussian, Results length = 148 symbols.

Description	Specifications	Supplemental Information
16, 32, 64, 128, 256DVBQAM <sup>a</sup> Symbol rate = 6.9 MHz Alpha = 0.15		
Residual errors		
Error vector magnitude (EVM) Frequency = 1.0 GHz		0.7 % rms (nominal)
QPSK <sup>b</sup> Symbol rate = 5 MHz		Operated with options 122 or 140 (IF Path = Wide) and 123 (Preselector = OFF)
Residual errors		$\alpha = 0.22$ (nominal)
Error vector magnitude (EVM) Frequency = 5.0 GHz		0.4 % rms
Frequency = 10.0 GHz		0.4 % rms
Frequency = 15.0 GHz		0.6 % rms
Frequency = 20.0 GHz		0.8 % rms
QPSK <sup>b</sup> Symbol rate = 15 MHz		Operated with options 122 or 140 (IF Path = Wide) and 123 (Preselector = OFF)
Residual errors		$\alpha = 0.22$ (nominal)
Error vector magnitude (EVM) Frequency = 5.0 GHz		0.6 % rms
Frequency = 10.0 GHz		0.7 % rms
Frequency = 15.0 GHz		0.8 % rms
Frequency = 20.0 GHz		1.2 % rms
QPSK <sup>b</sup> Symbol rate = 30 MHz		Operated with options 122 or 140 (IF Path = Wide) and 123 (Preselector = OFF)
Residual errors		$\alpha = 0.22$ (nominal)
Error vector magnitude (EVM) Frequency = 5.0 GHz		1.4 % rms
Frequency = 10.0 GHz		1.3 % rms
Frequency = 15.0 GHz		1.6 % rms
Frequency = 20.0 GHz		1.9 % rms

a. Meas Filter = Root Nyquist, Ref Filter = Nyquist, Results length = 800 symbols, EVM Ref Calc = RMS

b. Meas Filter = Root Nyquist, Ref Filter = Nyquist, Result length = 150 symbols

Description	Specifications	Supplemental Information
<p>QPSK Symbol rate = 50 MHz</p> <p>17.5 GHz</p> <p>24 GHz</p> <p>29 GHz</p> <p>36 GHz</p> <p>43 GHz</p>		<p>Operated with options 122 (IF Path = Wide) and 123 (Preselector = OFF). E4446A or E4448A only. Non-equalized, Root Raised Cosine filter (Alpha = 0.35). Opts 110/B7J<sup>a</sup></p> <p>2.4% (nominal)</p> <p>2.2% (nominal)</p> <p>4.2% (nominal)</p> <p>2.8% (nominal)</p> <p>3.1% (nominal)</p>
<p>64QAM<sup>b</sup> Symbol rate = 5 MHz</p> <p>Residual errors</p> <p>Error vector magnitude (EVM)</p> <p>Frequency = 5.0 GHz</p> <p>Frequency = 10.0 GHz</p> <p>Frequency = 15.0 GHz</p> <p>Frequency = 20.0 GHz</p>		<p>Operated with options 122 or 140 (IF Path = Wide) and 123 (Preselector = OFF)</p> <p><math>\alpha = 0.2</math> (nominal)</p> <p>0.3 % rms</p> <p>0.3 % rms</p> <p>0.4 % rms</p> <p>0.6 % rms</p>
<p>64QAM<sup>a</sup> Symbol rate = 15 MHz</p> <p>Residual errors</p> <p>Error vector magnitude (EVM)</p> <p>Frequency = 5.0 GHz</p> <p>Frequency = 10.0 GHz</p> <p>Frequency = 15.0 GHz</p> <p>Frequency = 20.0 GHz</p>		<p>Operated with options 122 or 140 (IF Path = Wide) and 123 (Preselector = OFF)</p> <p><math>\alpha = 0.2</math> (nominal)</p> <p>0.4 % rms</p> <p>0.5 % rms</p> <p>0.6 % rms</p> <p>0.9 % rms</p>
<p>64QAM<sup>a</sup> Symbol rate = 30 MHz</p> <p>Residual Errors</p> <p>Error vector magnitude (EVM)</p> <p>Frequency = 5.0 GHz</p> <p>Frequency = 10.0 GHz</p> <p>Frequency = 15.0 GHz</p> <p>Frequency = 20.0 GHz</p>		<p>Operated with options 122 or 140 (IF Path = Wide) and 123 (Preselector = OFF)</p> <p><math>\alpha = 0.2</math> (nominal)</p> <p>1.2 % rms</p> <p>1.2 % rms</p> <p>1.3 % rms</p> <p>1.4 % rms</p>

a. The PSA is installed with Options 110 and B7J, but Option 110 is Off.

b. Meas Filter = Root Nyquist, Ref Filter = Nyquist, Result length = 800 symbols, EVM Ref Calc = Max.







## Additional Definitions and Requirements

Because digital communications signals are noise-like, all measurements will have variations. The specifications apply only with adequate averaging to remove those variations.

The specifications for this chapter apply to the E4440A, E4443A and E4445A spectrum analyzers. For the E4446A, E4447A, and E4448A, the performance is nominal only and not subject to any warranted specifications.

The measurement performance is only slightly different in the E4446A, E4447A, and E4448A when compared to the performance of the E4440A, E4443A and E4445A analyzers. Because the hardware performance of the analyzers is very similar but not identical, you can estimate the nominal performance of the measurements from the specifications in this chapter.

### Option B7J, Basic Measurement Personality

Frequency Description	Specifications	Supplemental Information
Frequency Range	20 MHz to 3 GHz	

Description	Specifications		Supplemental Information
<b>Frequency Response</b> At all input attenuations Maximum error relative to reference condition (50 MHz)	+20 to +30 °C	0 to +55 °C	Typical
Attenuation = 0 to 2 dB			
20 to 810 MHz	±0.79 dB	±0.95 dB	±0.60 dB
810 to 960 MHz	±0.50 dB	±0.66 dB	±0.22 dB
960 to 1428 MHz	±0.59 dB	±0.75 dB	±0.22 dB
1428 to 1503 MHz	±0.41 dB	±0.57 dB	±0.15 dB
1503 to 1710 MHz	±0.59 dB	±0.75 dB	±0.22 dB
1710 to 2205 MHz	±0.41 dB	±0.57 dB	±0.15 dB
2205 to 3000 MHz	±1.17 dB	±1.33 dB	±0.66 dB
Attenuation ≥ 3 dB			
20 to 810 MHz	±0.69 dB	±0.85 dB	±0.28 dB
810 to 960 MHz	±0.41 dB	±0.57 dB	±0.15 dB
960 to 1428 MHz	±0.59 dB	±0.75 dB	±0.22 dB
1428 to 1503 MHz	±0.41 dB	±0.57 dB	±0.15 dB
1503 to 1710 MHz	±0.59 dB	±0.75 dB	±0.22 dB
1710 to 2205 MHz	±0.41 dB	±0.57 dB	±0.15 dB
2205 to 3000 MHz	±0.98 dB	±1.14 dB	±0.50 dB
<b>Electronic Input Attenuator</b>			The standard mechanical input attenuator is locked to 6 dB when using the electronic input attenuator.
Range	0 to +40 dB		
Step size	1 dB steps		
Accuracy at 50 MHz +20 °C to +30 °C	±0.15 dB relative to 10 dB electronic attenuation		±0.05 dB (typical)

Digital Communications Basic Measurement Personality  
**Additional Definitions and Requirements**

Description	Specifications	Supplemental Information
<p><b>Absolute Amplitude Accuracy</b></p> <p>Excluding: mismatch, scalloping, and IF flatness<sup>a</sup>            Including: linearity, RBW switching, attenuator,<sup>b</sup>            Freq. tuned to the input CW freq.</p> <p>At 50 MHz, +20 °C to +30 °C</p> <p>At 50 MHz, all temperatures</p> <p>At all frequencies            (Absolute amplitude accuracy at 50MHz + Frequency Response)</p> <p>+20 °C to +30 °C</p> <p>0 °C to +55 °C</p> <p>50 MHz Amplitude Ref. Accuracy</p>	<p>±0.25 dB</p> <p>±0.33 dB</p> <p>±(0.25 dB + frequency response)</p> <p>±(0.33 dB + frequency response)</p>	<p>±0.06 dB (typical)</p> <p>±(0.06 dB + frequency response) (typical)</p> <p>±0.05 dB (nominal)</p>

- a. Absolute amplitude error does not include input mismatch errors. It is tested only when the analyzer center frequency is tuned to the input CW frequency. In this test condition, the effects of FFT scalloping error and IF Flatness do not apply. FFT scalloping error, the possible variation in peak level as the signal frequency is varied between FFT bins, is a mathematical parameter of the FFT window; it is under 0.01 dB for the flattop window. IF flatness, the variation in measured amplitude with signal frequency variations across the span of an FFT result, is not specified separately for the digital communications personalities, but the errors caused by IF flatness are included in all individual personality specifications.
- b. Absolute amplitude error is tested at a combination of signal levels, spans, bandwidths and input attenuator settings. As a result, it is a measure of the sum of many errors normally specified separately for a spectrum analyzer: detection linearity (also known as scale or log fidelity), RBW switching uncertainty, attenuator switching uncertainty, IF gain accuracy, Amplitude Calibrator accuracy, and the accuracy with which the analyzer aligns itself to its internal calibrator.



## Measurements

### Spectrum

These specifications apply to the measurements available in Basic Mode.

Description	Specifications	Supplemental Information
<b>Spectrum</b>		
Span range	10 Hz to 10 MHz	1, 1.5, 2, 3, 5, 7.5, 10 sequence or arbitrary user-definable
Capture time		66 ns to 40 s 2 points to 200 kpoints Coupled to span and RBW
Resolution BW range		
Overall	100 MHz to 1 MHz	1, 1.5, 2, 3, 5, 7.5, 10 sequence or arbitrary user-definable
Span = 10 MHz	3 kHz to 5 kHz	
Span = 100 kHz	30 Hz to 500 kHz	
Span = 1 kHz	400 MHz to 7.5 kHz	
Span = 100 Hz	100 MHz to 2 kHz	
Pre-FFT filter		
Type	Gaussian, Flat	
BW	Auto, Manual 1 Hz to 10 MHz	
FFT window	Flat Top (high amplitude accuracy); Uniform; Hanning; Hamming; Gaussian; Blackman; Blackman-Harris; Kaiser-Bessel 70; K-B 90; K-B 110	
Displays	Spectrum, I/Q waveform, Simultaneous Spectrum & I/Q waveform	

## Waveform

Description	Specifications	Supplemental Information
<b>Waveform</b>		
Sweep time range <sup>a</sup>		
RBW ≤ 7.5 MHz	10 μs to 200 ms	
RBW ≤ 1 MHz	10 μs to 400 ms	
RBW ≤ 100 kHz	10 μs to 2 s	
RBW ≤ 10 kHz	10 μs to 20 s	
Time record length		2 to >900 kpoints (nominal)
Resolution bandwidth filter		1, 1.5, 2, 3, 5, 7.5, 10 sequence or arbitrary user-definable
Gaussian	10 Hz to 8 MHz	
Flat Top	10 Hz to 10 MHz	
Frequency response for 10 MHz setting		±0.25 dB over 8 MHz (nominal) -3 dB roll off bandwidth is 10 MHz (nominal)
Displays	RF envelope, I/Q waveform	
X-axis display		Allows expanded views of portions of the trace data.
Range	10 divisions × scale/div	
Controls	Scale/Div, Ref Value, and Ref Position	

- a. The maximum available sweep time range is proportional to the setting of the decimation (Meas Setup > Advanced > Decimation).  
 The limits shown are for decimation = 4, the maximum allowed. The default for decimation is 1.

Digital Communications Basic Measurement Personality  
**Measurements**

Description	Specifications	Supplemental Information
<p><b>Both Spectrum and Waveform</b></p> <p>Trigger</p> <p>    Source</p> <p>    Trigger delay</p> <p>        Range</p> <p>        Repeatability</p> <p>        Resolution</p> <p>    Trigger slope</p> <p>    Trigger hold off</p> <p>        Range</p> <p>        Resolution</p> <p>    Auto trigger</p> <p>        Time interval range</p> <p>    RF burst trigger</p> <p>        Peak carrier power range at RF Input</p> <p>    Trigger level range</p> <p>    Bandwidth</p> <p>    Video (IF envelope) trigger</p> <p>        Range</p> <p>Measurement Control</p> <p>Averaging</p> <p>    Avg number</p> <p>    Avg mode</p> <p>    Avg type</p> <p>Y-axis display controls</p> <p>Markers</p>	<p>Free Run (immediate), Video (IF envelope), RF Burst (wideband), Ext Front, Ext Rear, Frame, Line</p> <p>–100 ms to +500 ms</p> <p>±33 ns</p> <p>33 ns</p> <p>Positive, Negative</p> <p>0 to 500 ms</p> <p>1 μs</p> <p>On, Off</p> <p>+27 dBm to –40 dBm</p> <p>0 to –25 dB</p> <p>&gt;15 MHz (nominal)</p> <p>+30 dBm to noise floor</p> <p>Single, Continuous, Restart, Pause, Resume</p> <p>1 to 10,000</p> <p>Exponential, Repeat</p> <p>Power Avg (RMS), Log-Power Avg (Video), Voltage Avg, Maximum, Minimum</p> <p>Scale/Div, Ref Value, and Ref Position</p> <p>Normal, Delta, Band Power, Noise</p>	<p>For Video, RF Burst, Ext Front, Ext Rear</p> <p>0 to 10 s (nominal) Does an immediate trigger if no trigger occurs before the set time interval.</p> <p>Wideband IF for repetitive burst signals.</p> <p>Relative to signal peak</p> <p>&gt;15 MHz (nominal)</p> <p>Allows expanded views of portions of the trace data</p>



---

## Inputs and Outputs

### Front Panel

Description	Specifications	Supplemental Information
<b>RF Input</b> VSWR with electronic attenuator 7 MHz to 3 GHz  0 or 1 dB input attenuation ≥ 2 dB input attenuation		< 1.3:1 (nominal) < 1.2:1 (nominal)



---

## **6 GSM/EDGE Measurement Personality**

This chapter contains specifications for the PSA series, Option 202, GSM with EDGE measurement personality.

## Additional Definitions and Requirements

Because digital communications signals are noise-like, all measurements will have variations. The specifications apply only with adequate averaging to remove those variations.

The specifications apply in the frequency ranges documented in In-Band Frequency Range.

The specifications for this chapter apply to the E4440A, E4443A and E4445A spectrum analyzers. For the E4446A, E4447A, and E4448A, the performance is nominal only and not subject to any warranted specifications.

The measurement performance is only slightly different in the E4446A, E4447A, and E4448A when compared to the performance of the E4440A, E4443A and E4445A analyzers. Because the hardware performance of the analyzers is very similar but not identical, you can estimate the nominal performance of the measurements from the specifications in this chapter.

## Option 202, GSM/EDGE

Description	Specifications	Supplemental Information
<b>EDGE Error Vector Magnitude (EVM)</b>		Specifications based on 200 bursts
Carrier Power Range at RF Input		+24 to -45 dBm (nominal)
EVM		0 to 25 % (nominal)
Operating range <sup>a</sup>		0.3 % (typical)
Floor (RMS)	0.5 %	
Accuracy <sup>b</sup> (RMS) EVM range 1 % to 10 %	±0.5 %	+24 to -12 dBm power range at RF input
Frequency Error		
Accuracy	±1 Hz + tfa <sup>c</sup>	
IQ Origin Offset		
DUT Maximum Offset	-20 dBc	
Maximum Analyzer Noise Floor	-43 dBc	
Trigger to T0 Time Offset		
Relative Offset Accuracy		±5.0 ns (nominal)

- a. The operating range applies when the Burst Sync is set to Training Sequence.
- b. The accuracy specification applies when the Burst Sync is set to Training Sequence. The definition of accuracy for the purposes of this specification is how closely the result meets the expected result. That expected result is 0.975 times the actual RMS EVM of the signal, per 3GPP TS 5.05, annex G.
- c. tfa = transmitter frequency × frequency reference accuracy

Description	Specifications	Supplemental Information
<b>Power vs. Time</b> <i>and</i> <b>EDGE Power vs. Time</b>		GMSK modulation (GSM) 3π/8 shifted 8PSK modulation (EDGE)  Measures mean transmitted RF carrier power during the useful part of the burst (GSM method) and the power vs. time ramping. 510 kHz RBW

GSM/EDGE Measurement Personality  
Option 202, GSM/EDGE

Description	Specifications	Supplemental Information
Minimum carrier power at RF Input for GSM and EDGE		-40 dBm (nominal)
Absolute power accuracy for in-band signal (excluding mismatch error) <sup>a</sup>		
20 to 30 °C; attenuation > 2 dB <sup>b</sup>	-0.11 ±0.66 dB	-0.11 ±0.18 dB (typical)
20 to 30 °C; attenuation ≤ 2 dB <sup>b</sup>	-0.11 ±0.75 dB	-0.11 ±0.24 dB (typical)
0 to 55 °C; attenuation > 2 dB <sup>b</sup>	-0.11 ±0.90 dB	

- a. The power versus time measurement uses a resolution bandwidth of about 510 kHz. This is not wide enough to pass all the transmitter power unattenuated, leading the consistent error shown in addition to the uncertainty. A wider RBW would allow smaller errors in the carrier measurement, but would allow more noise to reduce the dynamic range of the low-level measurements. The measurement floor will change by  $10 \times \log(\text{RBW}/510 \text{ kHz})$ .

The average amplitude error will be about  $-0.11 \text{ dB} \times ((510 \text{ kHz}/\text{RBW})^2)$ . Therefore, the consistent part of the amplitude error can be eliminated by using a wider RBW.

- b. The absolute power accuracy depends on the setting of the electronic input attenuator as well as the signal-to-noise ratio. For high input levels, the Auto setting of RF Input Range will result in high signal-to-noise ratios and Input Atten > 2 dB, for which the Absolute power accuracy is best. At moderate levels, manually setting the Input Atten can give better accuracy than the automatic setting. At very low levels, automatic or manual setting of the Input Atten to 0 dB optimizes the accuracy by maximizing the signal-to-noise ratio.

For GSM and EDGE respectively, “high levels” would nominally be levels above -2.3 dBm and -5.5 dBm respectively, and “very low levels” would nominally be below -68 dBm.

The error due to very low signals levels is a function of the signal (mean transmit power) to noise (measurement floor) ratio, SN, in decibels. The function is  $\text{error} = 10 \times \log(1 + 10^{-\text{SN}/10})$ .

For example, if the mixer level (input power minus attenuation) is 26.4 dB above the measurement floor, the error due to adding the analyzer's noise to the UUT is only 0.01 dB.

Description	Specifications	Supplemental Information
<b>Power Ramp Relative Accuracy</b>		Referenced to mean transmitted power
RF Input Range = Auto <sup>a</sup> +6 dB to noise <sup>a b</sup>	±0.13 dB	
Mixer Level ≤ -12 dBm <sup>a</sup> 0 to +6 dB 0 to noise <sup>a b</sup>	±0.13 dB ±0.08 dB	
Mixer Level ≤ -18 dBm <sup>a</sup> +6 dB to noise	±0.08 dB	
Measurement floor		-88 dBm + Input Attenuation (nominal)
Time resolution	200 ns	

Description	Specifications	Supplemental Information
Burst to mask uncertainty	±0.2 bit (approx ±0.7 μs)	

- a. Using auto setting of RF Input range optimizes the dynamic range of analysis, but the scale fidelity is poorer at the relatively high mixer levels chosen. Because of this, manually setting the input attenuator so that the mixer level (RF Input power minus Input Attenuation) is lower can improve the relative accuracy of power ramp measurements as shown.
- b. The relative error specification does not change as the levels approach the noise floor, except for the effect of the noise power itself. If the mixer level is not high enough to make the contribution of the measurement floor negligible, the noise of the analyzer will add power to the signal being measured, resulting in an error. That error is a function of the signal (carrier power) to noise (measurement floor) ratio (SN), in decibels.

The function is  $\text{error} = 10 \times \log(1 + 10^{-SN/10})$ . For example, if the mixer level is 26.4 dB above the measurement floor, the error due to adding the noise of the analyzer to the UUT is only 0.01 dB.

GSM/EDGE Measurement Personality  
Option 202, GSM/EDGE

Description	Specifications	Supplemental Information
<b>Phase and Frequency Error</b>		GMSK modulation (GSM)
		Specifications based on 3GPP essential conformance requirements, and 200 bursts
Carrier power range at RF Input		+27 to -45 dBm (nominal)
Phase error		
Floor (RMS)	0.5 °	
Accuracy (RMS)	±0.5 °	
Phase error range	1 ° to 15 °	
Peak phase error		
Accuracy	±2.0 °	
Phase error range	3 ° to 25 °	
Frequency error		
Initial frequency error range		±75 kHz (nominal)
Accuracy	±5 Hz + tfa <sup>a</sup>	
I/Q Origin Offset		
DUT Maximum Offset		-15 dBc (nominal)
Analyzer Noise Floor		-50 dBc (nominal)
Burst sync time uncertainty	±0.1 bit (approx ±0.4 μs)	
Trigger to T0 time offset		
Relative offset accuracy		±5.0 ns (nominal)

a. tfa = transmitter frequency × frequency reference accuracy





Description	Specifications		Supplemental Information	
<b>Dynamic Range</b> <b>Spectrum due to modulation<sup>a</sup></b> <b>20 to 30 °C</b>			5-pole sync-tuned filters <sup>b</sup> Methods: Direct Time <sup>c</sup> and FFT <sup>d</sup>	
Offset Frequency	<b>GSM</b>	<b>EDGE</b>	<b>GSM (typical)</b>	<b>EDGE (typical)</b>
100 kHz <sup>e</sup>	67.3 dB	67.3 dB		
200 kHz	74.5 dB	74.5 dB		
250 kHz	76.9 dB	76.9 dB		
400 kHz	81.5 dB	81.3 dB		
600 kHz	85.6 dB	85.1 dB	87.7 dB	87.0 dB
1.2 MHz	91.0 dB	89.4 dB	92.8 dB	91.0 dB
			<b>GSM (nominal)</b>	<b>EDGE (nominal)</b>
1.8 MHz <sup>f</sup>	90.3 dB	90.2 dB	93.1 dB	92.0 dB
6.0 MHz	94.0 dB	93.7 dB	96.8 dB	94.5 dB

- a. Maximum dynamic range requires RF input power above  $-2$  dBm for offsets of 1.2 MHz and below. For offsets of 1.8 MHz and above, the required RF input power for maximum dynamic range is  $+6$  dBm for GSM signals and  $+5$  dBm for EDGE signals
- b. ORFS standards call for the use of a 5-pole, sync-tuned filter; this and the following footnotes review the instrument's conformance to that standard. Offset frequencies can be measured by using either the FFT method or the direct time method. By default, the FFT method is used for offsets of 400 kHz and below, and the direct time method is used for offsets above 400 kHz. The FFT method is slower and has lower dynamic range than the direct time method.
- c. The direct time method uses digital Gaussian RBW filters whose noise bandwidth (the measure of importance to "spectrum due to modulation") is within  $\pm 0.5$  % of the noise bandwidth of an ideal 5-pole sync-tuned filter. However, the Gaussian filters do not match the 5-pole standard behavior at offsets of 400 kHz and less, because they have *lower* leakage of the carrier into the filter. The lower leakage of the Gaussian filters provides a superior measurement because the leakage of the carrier masks the ORFS due to the UUT, so that less masking lets the test be more sensitive to variations in the UUT spectral splatter. But this superior measurement gives a result that does not conform with ORFS standards. Therefore, the default method for offsets of 400 kHz and below is the FFT method.
- d. The FFT method uses an exact 5-pole sync-tuned RBW filter, implemented in software.
- e. The dynamic range for offsets at and below 400 kHz is not directly observable because the signal spectrum obscures the result. These dynamic range specifications are computed from phase noise observations.
- f. Offsets of 1.8 MHz and higher use 100 kHz analysis bandwidths.

Description	Specifications	Supplemental Information
Dynamic Range, Spectrum due to switching <sup>a</sup> Offset Frequency  400 kHz  600 kHz  1.2 MHz  1.8 MHz	   72.1 dB  75.9 dB  80.2 dB  84.6 dB	5-pole sync-tuned filters <sup>a</sup>
<b>Spectrum (Frequency Domain)</b>	See “Spectrum” on page 150.	
<b>Waveform (Time Domain)</b>	See “Waveform” on page 151.	

- a. The impulse bandwidth (the measure of importance to “spectrum due to switching transients”) of the filter used in the direct time method is 0.8 % less than the impulse bandwidth of an ideal 5-pole sync-tuned filter, with a tolerance of  $\pm 0.5$  %. Unlike the case with spectrum due to modulation, the shape of the filter response (Gaussian vs. sync-tuned) does not affect the results due to carrier leakage, so the only parameter of the filter that matters to the results is the impulse bandwidth. There is a mean error of  $-0.07$  dB due to the impulse bandwidth of the filter, which is compensated in the measurement of ORFS due to switching. By comparison, an analog RBW filter with a  $\pm 10$  % width tolerance would cause a maximum amplitude uncertainty of 0.9 dB.

GSM/EDGE Measurement Personality  
Option 202, GSM/EDGE

Description	GSM Specifications	EDGE Specifications	Supplemental Information
<b>In-Band Frequency Ranges<sup>a</sup></b>			
GSM 900, P-GSM	890 to 915 MHz 935 to 960 MHz	890 to 915 MHz 935 to 960 MHz	
GSM 900, E-GSM	880 to 915 MHz 925 to 960 MHz	880 to 915 MHz 925 to 960 MHz	
DCS1800	1710 to 1785 MHz 1805 to 1880 MHz	1710 to 1785 MHz 1805 to 1880 MHz	
PCS1900	1850 to 1910 MHz 1930 to 1990 MHz		
GSM850	824 to 849 MHz 869 to 894 MHz		

a. Frequency ranges over which all specifications apply.

Description	GSM Specifications	EDGE Specifications	Supplemental Information
<b>Alternative Frequency Ranges<sup>a</sup></b>			
Down Band GSM	400 to 500 MHz	400 to 500 MHz	
GSM450	450.4 to 457.6 MHz 460.4 to 467.6 MHz		
GSM480	478.8 to 486 MHz 488.8 to 496 MHz		
GSM700	447.2 to 761.8 MHz		

a. Frequency ranges with tuning plans but degraded specifications for absolute power accuracy. The degradation should be nominally  $\pm 0.30$  dB.

Description	Specifications	Supplemental Information
<b>Trigger</b>		
Trigger source		RF burst (wideband), Video (IF envelope), Ext Front, Ext Rear, Frame Timer. Actual available choices dependent on measurement.
Trigger delay, level, and slope		Each trigger source has a separate set of these parameters.
Trigger delay		
Range	–100 to + 500 ms	
Repeatability	±33 ns	
Resolution	33 ns	
External trigger inputs		
Level Range	–5 to +5 V	
Impedance		10 kΩ (nominal)
<b>Burst Sync</b>		
Source		Training sequence, RF amplitude, None. Actual available choices dependent on measurement.
Training sequence code		GSM defined 0 to 7 Auto (search) or Manual
Burst type		Normal (TCH & CCH) Sync (SCH) Access (RACH)
<b>Range Control</b>		RF Input Autorange <sup>a</sup> Manually set <b>Max Total Pwr</b> Manually set <b>Input Atten</b>

- a. Auto range is *not* continuous with each measurement acquisition; it will run only once immediately following a measurement restart, initiated either by pressing the **Restart** key, or by sending the GPIB command `INIT:IMM`. This behavior was chosen to maintain best measurement speed, but it requires caution when input power levels change. If the input signal power changes, the analyzer will not readjust the input attenuators for optimal dynamic range unless a measurement restart is initiated. For example, if a sequence of power measurements is made, beginning with a maximum power level that is large enough to require non-zero input attenuation, it is advisable to do a measurement restart to automatically set a lower input attenuator value to maintain optimal dynamic range for approximately every 3 dB the input signal power level is reduced, or smaller, depending upon how precisely dynamic range needs to be optimized. Conversely, if the input signal power increases to a high enough level, input overloading will occur if the input attenuators are not readjusted by doing a measurement restart.





## Additional Definitions and Requirements

Because digital communications signals are noise-like, all measurements will have variations. The specifications apply only with adequate averaging to remove those variations.

The specifications apply in the frequency ranges documented in In-Band Frequency Range.

The specifications for this chapter apply to the E4440A, E4443A and E4445A spectrum analyzers. For the E4446A, E4447A, and E4448A, the performance is nominal only and not subject to any warranted specifications.

The measurement performance is only slightly different in the E4446A, E4447A, and E4448A when compared to the performance of the E4440A, E4443A and E4445A analyzers. Because the hardware performance of the analyzers is very similar but not identical, you can estimate the nominal performance of the measurements from the specifications in this chapter.



## Conformance With 3GPP TS 25.141 Base Station Requirements for a Manufacturing Environment

Sub-clause	Name	3GPP Required Test Instrument Tolerance (as of 2002-06)	Instrument Tolerance Interval <sup>a b c</sup>	Supplemental Information
<b>Conditions</b> 25 to 35 °C <sup>d</sup> Derived tolerances <sup>e</sup> 95th percentile <sup>d</sup> 100 % limit tested <sup>b</sup> Calibration uncertainties included <sup>d</sup>				
6.2.1	<b>Maximum Output Power</b>	±0.7 dB (95 %)	±0.28 dB (95 %)	±0.71 dB (100 %)
6.2.2	<b>CPICH Power Accuracy</b>	±0.8 dB (95 %)	±0.29 dB (95 %)	–10 dB CDP <sup>f</sup>
6.3.4	<b>Frequency Error</b>	±12 Hz (95 %)	±10 Hz (100 %)	Freq Ref locked <sup>g</sup>
6.4.2	<b>Power Control Steps<sup>h</sup></b>			
	1 dB step	±0.1 dB (95 %)	±0.03 dB (95 %)	Test Model 2
	0.5 dB step	±0.1 dB (95 %)	±0.03 dB (95 %)	Test Model 2
	Ten 1 dB steps	±0.1 dB (95 %)	±0.03 dB (95 %)	Test Model 2
	Ten 0.5 dB steps	±0.1 dB (95 %)	±0.03 dB (95 %)	Test Model 2
6.4.3	<b>Power Dynamic Range</b>	±1.1 dB (95 %)	±0.50 dB (95 %)	
6.4.4	<b>Total Power Dynamic Range<sup>h</sup></b>	±0.3 dB (95 %)	±0.015 dB (95 %)	Ref –35 dBm at mixer <sup>i</sup>
6.5.1	<b>Occupied Bandwidth</b>	±100 kHz (95 %)	±38 kHz (95 %)	10 averages <sup>j</sup>

- a. Those tolerances marked as 95 % are derived from 95th percentile observations with 95 % confidence.
- b. Those tolerances marked as 100 % are derived from 100 % limit tested observations. Only the 100 % limit tested observations are covered by the product warranty.
- c. The computation of the instrument tolerance intervals shown includes the uncertainty of the tracing of calibration references to national standards. It is added, in a root-sum-square fashion, to the observed performance of the instrument.
- d. This table is intended for users in the manufacturing environment, and as such, the tolerance limits have been computed for temperatures of the ambient air near the analyzer of 25 to 35 °C.
- e. Most of the tolerance limits in this table are derived from measurements made of standard instrument specifications, rather than direct observations.
- f. Tolerance limits are computed for a CPICH code domain power of –10 dB relative to total signal power.

**Conformance With 3GPP TS 25.141 Base Station Requirements for a Manufacturing Environment**

- g. The frequency references of the DUT and the test equipment must be locked together to meet this tolerance interval.
- h. These measurements are obtained by utilizing the code domain power function or general instrument capability. The tolerance limits given represent instrument capabilities.
- i. The tolerance interval is based on the largest signal power being  $-35$  dBm at the mixer.
- j. The OBW measurement errors are dominated by the noise-like nature of the signal. The errors decline in proportion to the square root of the number of averages. The tolerance interval shown is for ten averages.

W-CDMA Measurement Personality  
**Conformance With 3GPP TS 25.141 Base Station Requirements for a  
Manufacturing Environment**

Sub-clause	Name	3GPP Required Test Instrument Tolerance (as of 2002-06)	Instrument Tolerance Interval <sup>a b c</sup>	Supplemental Information
6.5.2.1	<b>Spectrum Emission Mask</b>	±1.5 dB (95 %)	±0.59 dB (95 %)	Absolute peak <sup>d</sup>
6.5.2.2	<b>ACLR</b>			
	5 MHz offset	±0.8 dB (95 %)	±0.22 dB (100 %)	
	10 MHz offset	±0.8 dB (95 %)	±0.22 dB (100 %)	
6.5.3	<b>Spurious Emissions</b>			
	f < 3 GHz	±1.5 to 2.0 dB (95 %)	±0.65 dB (100 %)	
	3 GHz < f < 4 GHz	±2.0 dB (95 %)	±1.77 dB (100 %)	
	4 GHz < f < 12.6 GHz	±4.0 dB (95 %)	±2.27 dB (100 %)	
6.7.1	<b>EVM</b>	±2.5 % (95 %)	±1.0 % (95 %)	Range 15 to 20 % <sup>e</sup>
6.7.2	<b>Peak Code Domain Error</b>	±1.0 dB (95 %)	±1.0 dB (nominal)	

- a. Those tolerances marked as 95 % are derived from 95th percentile observations with 95 % confidence.
- b. Those tolerances marked as 100 % are derived from 100 % limit tested observations. Only the 100 % limit tested observations are covered by the product warranty.
- c. The computation of the instrument tolerance intervals shown includes the uncertainty of the tracing of calibration references to national standards. It is added, in a root-sum-square fashion, to the observed performance of the instrument.
- d. The tolerance interval shown is for the peak absolute power of a CW-like spurious signal. The standards for SEM measurements are ambiguous as of this writing; the tolerance interval shown is based on Agilent's interpretation of the current standards and is subject to change.
- e. EVM tolerances apply with signals having EVMs within ±2.5 % of the required 17.5 % EVM limit.

W-CDMA Measurement Personality  
**Conformance With 3GPP TS 25.141 Base Station Requirements for a  
Manufacturing Environment**

Description	Specifications	Supplemental Information
<b>Channel Power</b>		
Minimum power at RF Input		-70 dBm (nominal)
Absolute power accuracy <sup>a</sup>		
20 to 30 °C, Attenuation > 2 dB <sup>b</sup>	±0.71 dB	±0.19 dB (typical)
20 to 30 °C, Attenuation ≤ 2 dB <sup>b</sup>	±0.80 dB	±0.25 dB (typical)
Measurement floor <sup>c</sup>		-78 dBm (nominal)

- a. Absolute power accuracy includes all error sources for in-band signals except mismatch errors and repeatability due to incomplete averaging. It applies when the mixer level is high enough that measurement floor contribution is negligible.
- b. The absolute power accuracy depends on the setting of the electronic input attenuator as well as the signal-to-noise ratio. For high input levels, the Auto setting of RF Input Range will result in high signal-to-noise ratios and Input Atten > 2 dB, for which the Absolute power accuracy is best. At moderate levels, manually setting the Input Atten can give better accuracy than the automatic setting. At very low levels, automatic or manual setting of the Input Atten to 0 dB optimizes the accuracy by maximizing the signal-to-noise ratio. For W-CDMA, “high levels” would nominally be levels above -14.4 dBm, and “very low levels” would nominally be below -58 dBm.  
The error due to very low signals levels is a function of the signal (channel power) to noise (measurement floor) ratio, SN, in decibels. The function is  $\text{error} = 10 \times \log(1 + 10^{-SN/10})$ . For example, if the mixer level (input power minus attenuation) is 26.4 dB above the measurement floor, the error due to adding the analyzer's noise to the UUT is only 0.01 dB.
- c. Measurement floor is the channel power measured due only to the noise of the analyzer. The measurement floor nominally changes by +1 dB/GHz for signal frequencies different from the 2 GHz frequency for which this nominal floor was determined.

Description		Specifications	Supplemental Information
<b>Adjacent Channel Power Ratio (ACPR; ACLR)<sup>a</sup></b>			Specifications apply for Sweep Method = FFT or Swp
Minimum power at RF Input			-27 dBm (nominal)
ACPR Accuracy <sup>b</sup>	Offset Freq.		RRC weighted, 3.84 MHz noise bandwidth
MS (UE)	5 MHz	±0.12 dB	At ACPR range of -30 to -36 dBc with optimum mixer level <sup>c</sup>
MS (UE)	10 MHz	±0.17 dB	At ACPR range of -40 to -46 dBc with auto-ranged <sup>d</sup>
BTS	5 MHz	±0.22 dB	At ACPR range of -42 to -48 dBc with optimum mixer level <sup>e</sup>
BTS	10 MHz	±0.22 dB	At ACPR range of -47 to -53 dBc with auto-ranged <sup>d</sup>
BTS	5 MHz	±0.17 dB	At -48 dBc non-coherent ACPR <sup>f</sup>

- a. Most versions of ACP measurements use negative numbers, in units of dBc, to refer to the power in an adjacent channel relative to the power in a main channel, in accordance with ITU standards. The standards for W-CDMA analysis include ACLR, a positive number represented in dB units. In order to be consistent with other kinds of ACP measurements, this measurement and its specifications will use negative dBc results, and refer to them as ACPR, instead of positive dB results referred to as ACLR. The ACLR can be determined from the ACPR reported by merely reversing the sign.
- b. The ACPR level accuracy depends on the mixer drive level and whether the distortion products from the analyzer are coherent with those in the UUT. Except for the “non-coherent case” described in footnote f, the specifications apply even in the worst case condition of coherent analyzer and UUT distortion products. For ACPR levels other than those in this specifications table, the optimum mixer drive level for accuracy is approximately -29 dBm - (ACPR/3), where the ACPR is given in (negative) decibels.
- c. In order to meet this specified accuracy when measuring mobile station (MS) or user equipment (UE) within 3 dB of the required -33 dBc ACPR, the mixer level (ML) must be optimized for accuracy. This optimum mixer level is -18 dBm, so the input attenuation must be set as close as possible to the average input power - (-18 dBm). For example, if the average input power is -6 dBm, set the attenuation to 12 dB. This specification applies for the normal 3.5 dB peak-to-average ratio of a single code. Note that, if the mixer level is set to optimize dynamic range instead of accuracy, accuracy errors are nominally doubled.
- d. ACPR accuracy at 10 MHz offset is warranted when RF Input Range is set to Auto.
- e. In order to meet this specified accuracy, the mixer level must be optimized for accuracy when measuring Node-B of the Base Transmission Station (BTS) within 3 dB of the required -45 dBc ACPR. This optimum mixer level is -14 dBm, so the input attenuation must be set as close as possible to the average input power - (-14 dBm). For example, if the average input power is -6 dBm, set the attenuation to 8 dB. This specification applies for the normal 10 dB peak-to-average ratio (at 0.01 % probability) for Test Model 1. Note that, if the mixer level is set to optimize dynamic range instead of accuracy, accuracy errors are nominally doubled.

- f. Accuracy can be excellent even at low ACPR levels assuming that the user sets the mixer level to optimize the dynamic range, and assuming that the analyzer and UUT distortions are incoherent. When the errors from the UUT and the analyzer are incoherent, optimizing dynamic range is equivalent to minimizing the contribution of analyzer noise and distortion to accuracy, though the higher mixer level increases the display scale fidelity errors. This incoherent addition case is commonly used in the industry and can be useful for comparison of analysis equipment, but this incoherent addition model is rarely justified.

Description	Specifications	Supplemental Information
<b>Dynamic Range</b> Offset Frequency 5 MHz 10 MHz		RRC weighted, 3.84 MHz noise bandwidth  –74.5 dB (nominal) <sup>a</sup>  –82 dB (nominal) <sup>a</sup>

a. The averaged input power level should be at least –1 dBm and RF Input Range is set to Auto

Description	Specifications	Supplemental Information
<b>Multi-Carrier Power</b> Minimum Carrier Power at RF Input ACPR Dynamic Range, two carriers 5 MHz offset 10 MHz offset ACPR Accuracy, two carriers 5 MHz offset, –48 dBc ACPR		–12 dBm (nominal)  RRC weighted, 3.84 MHz noise bandwidth  –70 dB (nominal) –75 dB (nominal)  ±0.38 dB (nominal)

Description	Specifications	Supplemental Information
<b>Power Statistics CCDF</b> Minimum Power at RF Input Histogram Resolution	0.01 dB <sup>a</sup>	–40 dBm, average (nominal)

a. The Complementary Cumulative Distribution Function (CCDF) is a reformatting of the histogram of the power envelope. The width of the amplitude bins used by the histogram is the histogram resolution. The resolution of the CCDF will be the same as the width of those bins.

W-CDMA Measurement Personality  
**Conformance With 3GPP TS 25.141 Base Station Requirements for a  
Manufacturing Environment**

Description	Specifications	Supplemental Information
<b>Intermodulation</b> Minimum Carrier Power at RF Input Third-order Intercept CF = 1 GHz CF = 2 GHz		-30 dBm (nominal)  TOI + 7.2 dB <sup>a</sup>  TOI + 7.5 dB <sup>a</sup>

- a. The third-order intercept (TOI) of the analyzer as configured for the W-CDMA personality is higher than the third-order intercept specified for the analyzer without the personality, due to the configuration of loss elements in front of the input mixer. The personality configures the mechanical attenuator to be in a fixed 6 dB attenuation position, and has additional loss in the electronic attenuator. The TOI increases by the nominal amount shown due to these losses when the electronic attenuator is set to 0 dB, and further increases proportional to the setting of the electronic attenuator.



Description	Specifications	Supplemental Information
<b>Occupied Bandwidth</b>		
Minimum carrier power at RF Input		−40 dBm (nominal)
Frequency Resolution	100 Hz	
Frequency Accuracy		$\frac{1.4\%}{\sqrt{N_{avg}}}$ (nominal) <sup>a</sup>
Spectrum Emission Mask		
Minimum power at RF Input		−20 dBm (nominal)
Dynamic Range, relative <sup>b</sup>		
2.515 MHz offset <sup>c</sup>	−86.7 dB	−88.9 dB (typical)
1980 MHz region <sup>d</sup>	−80.7 dB	−83.0 dB (typical)
Sensitivity, absolute <sup>e</sup>		
2.515 MHz offset <sup>f</sup>	−97.9 dBm	−99.9 dBm (typical)
1980 MHz region <sup>g</sup>	−81.9 dBm	−83.9 dBm (typical)
Accuracy, relative		
Display = Abs Peak Pwr	±0.14 dB	
Display = Rel Peak Pwr	±0.56 dB	

- a. The errors in Occupied Bandwidth measurement are due mostly to the noisiness of any measurement of a noise-like signal, such as the W-CDMA signal. The observed standard deviation of the OBW measurement is 60 kHz, so with 1000 averages, the standard deviation should be about 2 kHz, or 0.05 %. The frequency errors due to the FFT processing are computed to be 0.028 % with the RBW (30 kHz) used.
- b. The dynamic range specification is the ratio of the channel power to the power in the offset and region specified. The dynamic range depends on the measurement settings, such as peak power or integrated power. This specification is derived from other analyzer performance limitations such as third-order intermodulation, DANL and phase noise. Dynamic range specifications are based on default measurement settings, with detector set to average, and depend on the mixer level. Mixer level is defined to be the input power minus the input attenuation.
- c. Default measurement settings include 30 kHz RBW. This dynamic range specification applies for the optimum mixer level, which is about −9 dBm.
- d. Default measurement settings include 1200 kHz RBW. This dynamic range specification applies for a mixer level of 0 dBm. Higher mixer levels can give up to 5 dB better dynamic range, but at the expense of compression in the input mixer, which reduces accuracy. The compression behavior of the input mixer is specified in the PSA Specifications Guide; the levels into the mixer are nominally 8 dB lower in this application when the center frequency is 2 GHz.
- e. The sensitivity is specified with 0 dB input attenuation. It represents the noise limitations of the analyzer. It is tested without an input signal.
- f. The sensitivity at this offset is specified in the default 30 kHz RBW.
- g. The sensitivity for this region is specified in the default 1200 kHz bandwidth.





- d. CPICH synchronization can be obtained above  $-45$  dBm, but TOI products will begin to raise the code domain noise floor. The power range that is free from TOI-induced noise floor problems can be extended up to 20 dB by increasing the input attenuation above the factory preset setting of 0 dB when using the preamplifier. There is no auto mode for setting input attenuation when the preamplifier is On.

Description	Specifications	Supplemental Information
Relative accuracy Test signal Test Model 1 with 32 DPCH signal Code domain power range 0 to -25 dBc -25 to -40 dBc  Symbol error vector magnitude  Minimum power at RF Input  Accuracy Test signal Test Model 1 with 32 DPCH signal Code domain power range 0 to -25 dBc		±0.10 dB ±0.50 dB          -50 dBm (nominal) <sup>a b</sup>          ±1.0 %

- a. CPICH synchronization requires a minimum RF input power of -102 dBm. CPICH synchronization can be achieved for RF input power down to -112 dBm, but lock will not be consistent.
- b. CPICH synchronization can be obtained above -45 dBm, but TOI products will begin to raise the code domain noise floor. The power range that is free from TOI-induced noise floor problems can be extended up to 20 dB by increasing the input attenuation above the factory preset setting of 0 dB when using the preamplifier. There is no auto mode for setting input attenuation when the preamplifier is On.

W-CDMA Measurement Personality  
**Conformance With 3GPP TS 25.141 Base Station Requirements for a  
Manufacturing Environment**

Description	Specifications	Supplemental Information
<b>QPSK EVM</b>		
Preamp (Option 1DS) Off, except as noted.		
Minimum power at RF Input		-20 dBm (nominal)
<b>QPSK Downlink</b>		
<b>EVM</b>		
Operating range		0 to 25 % (nominal)
Floor		
Preamp ( <i>Option 1DS</i> ) Off	1.5 %	1.5 % (nominal)
Preamp ( <i>Option 1DS</i> ) On		RF input power = -50 dBm, Attenuator = 0 dB
Accuracy <sup>a</sup>		±1.0 % (nominal) at EVM of 10 %
I/Q origin offset		-10 dBc (nominal)
DUT Maximum Offset		-50 dBc (nominal)
Analyzer Noise Floor		
Frequency error		±300 kHz (nominal)
Range		
Accuracy		±10 Hz (nominal) + tfa <sup>b</sup>
<b>12.2 k RMC Uplink</b>		
<b>EVM</b>		
Operating range		0 to 20 % (nominal)
Floor		1.5 % (nominal)
Accuracy <sup>a</sup>		±1.0 % (nominal) at EVM of 10 %
I/Q origin offset		
DUT Maximum Offset		-10 dBc (nominal)
Analyzer Noise Floor		-50 dBc (nominal)
Frequency error		
Range		±20 kHz (nominal)
Accuracy		±10 Hz (nominal) + tfa <sup>b</sup>

- a. The accuracy specification applies when the EVM to be measured is well above the measurement floor. When the EVM does not greatly exceed the floor, the errors due to the floor add to the accuracy errors. The errors due to the floor are noise-like and add incoherently with the UUT EVM. The errors depend on the EVM of the UUT and the floor as follows:  $\text{error} = \sqrt{\text{EVMUUT}^2 + \text{EVMsa}^2} - \text{EVMUUT}$ , where EVMUUT is the EVM of the UUT in percent, and EVMsa is the EVM floor of the analyzer in percent. For example, if the EVM of the UUT is 7 %, and the floor is 2.5 %, the error due to the floor is 0.43 %. The total error can cause a reading as high as  $\text{EVMUUT} + \text{floorerror} + \text{accyerror}$ , or as low as  $\text{EVMUUT} - \text{accyerror}$ , where floorerror is the result of the error computation due to the floor, and accyerror is the specified accuracy.
- b.  $\text{tfa} = \text{transmitter frequency} \times \text{frequency reference accuracy}$





- h. The accuracy specification applies when the EVM to be measured is well above the measurement floor. When the EVM does not greatly exceed the floor, the errors due to the floor add to the accuracy errors. The errors due to the floor are noise-like and add incoherently with the UUT EVM. The errors depend on the EVM of the UUT and the floor as follows:  $\text{error} = \sqrt{\text{EVMUUT}^2 + \text{EVMsa}^2} - \text{EVMUUT}$ , where EVMUUT is the EVM of the UUT in percent, and EVMsa is the EVM floor of the analyzer in percent. For example, if the EVM of the UUT is 7 %, and the floor is 2.5 %, the error due to the floor is 0.43 %. The total error can cause a reading as high as  $\text{EVMUUT} + \text{floorerror} + \text{accyerror}$ , or as low as  $\text{EVMUUT} - \text{accyerror}$ , where floorerror is the result of the error computation due to the floor, and accyerror is the specified accuracy.



Description	Specifications	Supplemental Information
<b>Power Control and Power vs. Time</b>		
Absolute power measurement		Using 5 MHz resolution bandwidth
Accuracy		
0 to -20 dBm		±0.7 dB (nominal)
-20 to -60 dBm		±1.0 dB (nominal)
Relative power measurement		
Accuracy		
Step range ±1.5 dB		±0.1 dB (nominal)
Step range ±3.0 dB		±0.15 dB (nominal)
Step range ±4.5 dB		±0.2 dB (nominal)
Step range ±26.0 dB		±0.3 dB (nominal)

---

## Frequency

Description	Specifications	Supplemental Information
<b>In-Band Frequency Range</b>	2110 to 2170 MHz 1920 to 1980 MHz	

## General

Description	Specifications	Supplemental Information
<b>Trigger</b>		
Trigger source		RF burst (wideband), Video (IF envelope), Ext Front, Ext Rear. Actual choices are dependent on measurement.
Trigger delay, level, & slope		Each trigger source has separate set of these parameters.
Trigger delay		
Range	-100 to +500 ms	
Repeatability	±33 ns	
Resolution	33 ns	
External trigger inputs		
Level		-5 V to +5 V (nominal)
Impedance		10 kΩ (nominal)
<b>Range Control</b>		RF Input Autorange <sup>a</sup> Manually set <b>Max Total Pwr</b> Manually set <b>Input Atten</b>

- a. Autorange is not continuous with each measurement acquisition; it will run only once immediately following a measurement restart, initiated either by pressing Restart or by sending the GPIB command INIT:IMM. This behavior was chosen to maintain best measurement speed, but it requires caution when input power levels change. If the input signal power changes, the analyzer will not readjust the input attenuators for optimal dynamic range unless a measurement restart is initiated. For example, if a sequence of power measurements is made, beginning with a maximum power level that is large enough to require non-zero input attenuation, it is advisable to do a measurement restart to automatically set a lower input attenuator value to maintain optimal dynamic range for approximately every 3 dB the input signal power level is reduced, or smaller, depending upon how precisely dynamic range needs to be optimized. Conversely, if the input signal power increases to a high enough level, input overloading will occur if the input attenuators are not readjusted by doing a measurement restart.





## Additional Definitions and Requirements

Because digital communications signals are noise-like, all measurements will have variations. The specifications apply only with adequate averaging to remove those variations.

The specifications apply in the frequency ranges documented in In-Band Frequency Range.

The specifications for this chapter apply to the E4440A, E4443A and E4445A spectrum analyzers. For the E4446A, E4447A, and E4448A, the performance is nominal only and not subject to any warranted specifications.

The measurement performance is only slightly different in the E4446A, E4447A, and E4448A when compared to the performance of the E4440A, E4443A and E4445A analyzers. Because the hardware performance of the analyzers is very similar but not identical, you can estimate the nominal performance of the measurements from the specifications in this chapter.





Description	Specifications	Supplemental Information
Relative accuracy <sup>a</sup>		
Test signal		
Test Model 2		
Code domain power range		
0 to -10 dBc		±0.015 dB
10 to -30 dBc		±0.06 dB
-30 to -40 dBc		±0.07 dB
Test Model 1 with 32 DPCH		
Code domain power range		
0 to -10 dBc		±0.015 dB
-10 to -30 dBc		±0.08 dB
-30 to -40 dBc		±0.15 dB
Test Model 5 with 8 HS-PDSCH		
Code domain power range		
0 to -10 dBc		±0.015 dB (nominal)
-10 to -30 dBc		±0.08 dB (nominal)
-30 to -40 dBc		±0.15 dB (nominal)

- a. A code channel power measurement made on a specific spreading code includes all power that projects onto that code. This power is primarily made up from the intended signal power that was spread using that code, but also includes that part of the SCH power (when present) that also projects onto the code being measured. The reason for this addition is that the SCH power is spread using a gold code, which is not orthogonal to the code being measured. The increase in decibels due to this SCH leakage effect is given by the following formula:

$$SCHleakage(dB) = 10\log\left(10^{\frac{S}{10}} \div (10F) + 10^{\frac{C}{10}}\right) - C$$

Where:

S = Relative SCH power in dB (during the first 10 % of each timeslot)

F = Spreading factor of the code channel being measured

C = Ideal relative code channel power in dB (excluding SCH energy)

For example, consider a composite signal comprising the SCH set to -10 dB during the first 10 % of each slot, and a DPCH at spreading factor 128 set to -28 dB. Performing a code channel power measurement on the DPCH will return a nominal code channel power measurement of -27.79 dB. The SCH leakage effect of 0.21 dB should not be considered as a measurement error but rather the expected consequence of the non-orthogonal SCH projecting energy onto the code used by the DPCH.

In order to calculate the ideal code channel power C from a code channel power measurement M that includes SCH energy, the following formula can be used:

$$C(dB) = 10\log\left(10^{\frac{M}{10}} - 10^{\frac{S}{10}} \div (10F)\right)$$

Therefore a code channel power measurement M = -27.79 dB at spreading factor 128 of a signal including a relative SCH power of -10 dB indicates an ideal code channel power of -28 dB.

Description	Specifications	Supplemental Information
Symbol power vs. time <sup>a</sup>		
Minimum power at RF Input		–50 dBm (nominal) <sup>b c</sup>
Relative accuracy		
Test signal		
Test Model 1 with 32 DPCH signal		
Code domain power range		
0 to –25 dBc	0 to –25 dBc	±0.10 dB
–25 to –40 dBc	–25 to –40 dBc	±0.50 dB
Test Model 5 with 8 HS-PDSCH signal		
Code domain power range		
0 to –25 dBc		±0.10 dB (nominal)
–25 to –40 dBc		±0.50 dB (nominal)
Symbol error vector magnitude		
Minimum power at RF Input		–50 dBm (nominal)
Accuracy		
Test signal		
Test Model 1 with 32 DPCH signal		
Code domain power range		
0 to –25 dBc		±1.0 %

- a. Relative accuracy applies when examining data outside of where SCH is active.
- b. Nominal operating range. Accuracy specifications apply when mixer level (RF input power minus attenuation) is between –25 and –15 dBm.
- c. CPICH synchronization requires a minimum RF input power of –102 dBm. CPICH synchronization can be achieved for RF input power down to –112 dBm, but lock will not be consistent.

HSDPA/HSUPA Measurement Personality  
**Option 210, HSDPA/HSUPA Measurement Personality**

Description	Specifications	Supplemental Information
<p><b>Modulation Accuracy (Composite EVM)</b></p> <p>BTS Measurements  <math>-25 \text{ dBm} \leq \text{ML}^a \leq -15 \text{ dBm}</math>            Preamp (<i>Option 1DS</i>) Off, except as noted</p> <p>Composite EVM</p> <p>Minimum power at RF input            Preamp (<i>Option 1DS</i>) Off            Preamp (<i>Option 1DS</i>) On</p> <p>Maximum power at RF input            Preamp (<i>Option 1DS</i>) On</p> <p>Test Model 4            Range            Floor            Accuracy<sup>f</sup></p> <p>Test Model 1 with 32 DPCH            Range            Floor            Accuracy<sup>f</sup></p> <p>Test Model 5 with 8 HS-PDSCH            Range            Floor            Accuracy<sup>f</sup></p>	<p>0 to 25 %            1.5 %</p> <p>0 to 25 %            1.5 %</p>	<p>Following specifications are 95 %, unless stated as (nominal).</p> <p>–75 dBm (nominal)<sup>b c</sup>            –102 dBm (nominal)<sup>d</sup></p> <p>–45 dBm (nominal)<sup>e</sup></p> <p>±1.0 % (nominal)</p> <p>±1.0 % (nominal)</p> <p>0 to 25 % (nominal)            1.5 % (nominal)            ±1.0 % (nominal)</p>

- a. ML (mixer level) is RF input power minus attenuation.
- b. Predefined test models under the Symbol Boundary menu are recommended for RF input power levels below –60 dBm. At low signal-to-noise ratios the auto channel ID algorithm may not correctly detect an active code channel as turned on. The predefined test model bypasses the auto channel ID algorithm.
- c. Nominal operating range. Accuracy specification applies when mixer level (RF input power minus attenuation) is between –25 and –15 dBm.
- d. CPICH synchronization requires a minimum RF input power of –102 dBm. CPICH synchronization can be achieved for RF input power down to –112 dBm, but lock will not be consistent.
- e. CPICH synchronization can be achieved for RF input power down to –112 dBm, but lock will not be consistent. CPICH synchronization can be obtained above –45 dBm, but TOI products will begin to raise the EVM floor. The power range that is free from TOI-induced noise floor problems can be extended up to 20 dB by increasing the input attenuation above the factory preset setting of 0 dB when using the preamplifier. There is no auto mode for setting input attenuation when the preamplifier is On.



## Frequency

Description	Specifications	Supplemental Information
<b>In-Band Frequency Range</b>	2110 to 2170 MHz 1920 to 1980 MHz	

## General

Description	Specifications	Supplemental Information
<b>Trigger</b> Trigger source Trigger delay, level, & slope Trigger delay Range Repeatability Resolution External trigger inputs Level Impedance	-100 to +500 ms ±33 ns 33 ns	RF burst (wideband), Video (IF envelope), Ext Front, Ext Rear. Actual choices are dependent on measurement. Each trigger source has separate set of these parameters. -5 V to +5 V (characteristic) 10 kW (nominal)
<b>Range Control</b>		RF Input Autorange <sup>a</sup> Manually set <b>Max Total Pwr</b> Manually set <b>Input Atten</b>

- a. Auto range is not continuous with each measurement acquisition; it will run only once immediately following a measurement restart, initiated either by pressing the **Restart** key, or by sending the GPIB command `INIT:IMM`. This behavior was chosen to maintain best measurement speed, but it requires caution when input power levels change. If the input signal power changes, the analyzer will not readjust the input attenuators for optimal dynamic range unless a measurement restart is initiated. For example, if a sequence of power measurements is made, beginning with a maximum power level that is large enough to require non-zero input attenuation, it is advisable to do a measurement restart to automatically set a lower input attenuator value to maintain optimal dynamic range for approximately every 3 dB the input signal power level is reduced, or smaller, depending upon how precisely dynamic range needs to be optimized. Conversely, if the input signal power increases to a high enough level, input overloading will occur if the input attenuators are not readjusted by doing a measurement restart.





---

## **9** **cdmaOne Measurement Personality**

This chapter contains specifications for the PSA series, *Option BAC*, *cdmaOne* measurement personality.

## **Additional Definitions and Requirements**

Because digital communications signals are noise-like, all measurements will have variations. The specifications apply only with adequate averaging to remove those variations.

The specifications apply in the frequency ranges documented in In-Band Frequency Range.

The specifications for this chapter apply to the E4440A, E4443A and E4445A spectrum analyzers. For the E4446A, E4447A, and E4448A, the performance is nominal only and not subject to any warranted specifications.

The measurement performance is only slightly different in the E4446A, E4447A, and E4448A when compared to the performance of the E4440A, E4443A and E4445A analyzers. Because the hardware performance of the analyzers is very similar but not identical, you can estimate the nominal performance of the measurements from the specifications in this chapter.

## Option BAC, cdmaOne Measurements Personality

Description	Specifications	Supplemental Information
<b>Channel Power Measurement</b>		
1.23 MHz Integration BW		
Minimum power at RF Input		-75 dBm (nominal)
Absolute power accuracy <sup>a</sup> 20 °C to 30 °C		
attenuation > 2 dB <sup>b</sup>	±0.67 dB	±0.18 dB (typical)
attenuation ≤ 2 dB	±0.76 dB	±0.24 dB (typical)
Measurement floor <sup>c</sup>		-86 dBm + Input Attenuation (nominal)
Relative power accuracy	±0.08 dB	±0.03 dB (typical)
Fixed channel		
Fixed input attenuator		
Mixer level -52 to -12 dBm <sup>d</sup>		

- a. Absolute power accuracy includes all error sources for in-band signals except mismatch errors. There are two cases listed.
- b. The absolute power accuracy depends on the setting of the electronic input attenuator as well as the signal-to-noise ratio. For high input levels, the Auto setting of RF Input Range will result in high signal-to-noise ratios and Input Atten > 2 dB, for which the absolute power accuracy is best. At moderate levels, manually setting the Input Atten can give better accuracy than the automatic setting. At very low levels, automatic or manual setting of the Input Atten to 0 dB optimizes the accuracy by maximizing the signal-to-noise ratio.  
For cdmaOne, “high levels” would nominally be levels above -14.7 dBm, and “very low levels” would nominally be below -66 dBm.  
The error due to very low signals levels is a function of the signal (channel power) to noise (measurement floor) ratio, SN, in decibels.  
The function is:  
For example, if the mixer level (input power minus attenuation) is 26.4 dB above the measurement floor, the error due to adding the analyzer's noise to the UUT is only 0.01 dB.
- c. Measurement floor is the channel power measured due only to the noise of the analyzer. The measurement floor nominally changes by +1 dB/GHz for signal frequencies different from the 1 GHz frequency for which this nominal floor was determined.
- d. The relative accuracy is the ratio of the accuracy of amplitude measurements of two different transmitter power levels. Mixer level is defined to be the input power minus the attenuation. This specification is equivalent to the difference between two points on the scale fidelity curve shown in the PSA Specifications Guide. The error sources of scale fidelity are almost all monotonic with input level, so the relative error between two levels is nearly (within 0.01 dB) identical to the “error relative to -35 dBm” specified in the Guide.

cdmaOne Measurement Personality  
**Option BAC, cdmaOne Measurements Personality**

Description	Specifications	Supplemental Information
<b>Code Domain (Base Station)</b>		
Minimum power at RF Input		-40 dBm (nominal)
Measurement interval range	0.5 to 30 ms	
Code domain power		Measurement interval $\geq$ 2.0 ms
Dynamic Range		50 dB (nominal)
Relative Power Accuracy	$\pm 0.3$ dB	Walsh channel power within 20 dB of total power
Other reported power parameters	Average active traffic Maximum inactive traffic Average inactive traffic Pilot, paging, sync channels	dB readings for these power measurements are referenced to total power
Frequency error		Measurement interval $\geq$ 2.0 ms
Input frequency error range	$\pm 900$ Hz	
Accuracy	$\pm 10$ Hz + tfa <sup>a</sup>	
Pilot time offset		From even second signal to start of PN sequence
Range	-13.33 ms to +13.33 ms	
Accuracy	$\pm 300$ ns	
Resolution	10 ns	
Code domain timing		Pilot to code channel time tolerance; measurement interval $\geq$ 2.0 ms
Range	$\pm 200$ ns	
Accuracy	$\pm 10$ ns	
Resolution	0.1 ns	
Code domain phase		Pilot to code channel phase tolerance; measurement interval $\geq$ 2.0 ms
Range	$\pm 200$ mrad	
Accuracy	$\pm 10$ mrad	
Resolution	0.1 mrad	

a. tfa = transmitter frequency  $\times$  frequency reference accuracy

Description	Specifications	Supplemental Information
<b>Modulation Accuracy</b>		
Minimum power at RF Input		-40 dBm (nominal)
Measurement interval range	0.5 to 30 ms	
Rho (waveform quality)		Measurement interval $\geq$ 2.0 ms
Range	0.9 to 1.0	Operating range 0.5 to 1.0
Accuracy		
0.9 < Rho < 1.0	$\pm 0.001$	
Resolution	0.0001	
Frequency error		Measurement interval $\geq$ 2.0 ms
Input frequency error range	$\pm 900$ Hz	
Accuracy	$\pm 10$ Hz + tfa <sup>a</sup>	
Base station pilot time offset		From even second signal to start of PN sequence
Range	-13.33 ms to +13.33 ms	
Accuracy	$\pm 300$ ns	
Resolution	10 ns	
EVM (RMS)		Measurement interval $\geq$ 2.0 ms
Floor	2.0 %	1.5 % (typical)
Accuracy <sup>b</sup>	$\pm 0.5$ %	
Range 0 to 14 %		
Carrier feed through		
Floor	-55 dBc	
Accuracy	$\pm 2.0$ dB	

a. tfa = transmitter frequency  $\times$  frequency reference accuracy

b. The accuracy specification applies when the EVM to be measured is well above the measurement floor. When the EVM does not greatly exceed the floor, the errors due to the floor add to the accuracy errors. The errors due to the floor are noise-like and add incoherently with the UUT EVM. The errors depend on the EVM of the UUT and the floor as follows:  $\text{error} = \sqrt{\text{EVMUUT}^2 + \text{EVMsa}^2} - \text{EVMUUT}$ , where EVMUUT is the EVM of the UUT in percent, and EVMsa is the EVM floor of the analyzer in percent. For example, if the EVM of the UUT is 7 %, and the floor is 2.5 %, the error due to the floor is 0.43 %. The total error can cause a reading as high as  $\text{EVMUUT} + \text{floorerror} + \text{accyerror}$ , or as low as  $\text{EVMUUT} - \text{accyerror}$ , where floorerror is the result of the error computation due to the floor, and accyerror is the specified accuracy.

cdmaOne Measurement Personality  
Option BAC, cdmaOne Measurements Personality

Description		Specifications	Supplemental Information
<b>Adjacent Channel Power Ratio</b>			
Minimum power at RF Input			-39 dBm (nominal)
Dynamic Range <sup>a</sup>			Referenced to average power in 1.23 MHz BW
Offset Freq. (kHz)	Integ. BW (kHz)		
750	30	-86.7 dB	Mixer level = -12 dBm
885	30	-86.3 dB	Mixer level = -12 dBm
1256.25	12.5	-90.8 dB	Mixer level = -12 dBm
1265	30	-87.0 dB	Mixer level = -12 dBm
1980	30	-87.8 dB	
2750	1000	-72.7 dB	
ACPR Relative Accuracy			
Offsets < 1.30 MHz <sup>b</sup>		±0.09 dB	
Offsets > 1.85 MHz <sup>c</sup>		±0.09 dB	

- a. The optimum mixer level (mixer level is defined to be the average input power minus the input attenuation) is different for optimum ACPR dynamic range than the Auto setting of RF Input Level. For optimum dynamic range, the ideal mixer level is about -12 dBm for the 750 kHz offset, which is close to the input overload threshold. The setting for mixer level when RF Input Level is set to Auto is about -17 dBm. The advantage of the Auto setting is that it gives a greater range of allowable input peak-to-average ratios without registering an input overload.
- b. The specified ACPR accuracy applies if the measured ACPR substantially exceeds the analyzer dynamic range at the specified offset. When this condition is not met, there are additional errors due to the addition of analyzer spectral components to UUT spectral components. In the worst case at these offsets, the analyzer spectral components are all coherent with the UUT components; in a more typical case, one third of the analyzer spectral power will be coherent with the distortion components in the UUT. Coherent means that the phases of the UUT distortion components and the analyzer distortion components are in a fixed relationship, and could be perfectly in-phase. This coherence is not intuitive to many users, because the signals themselves are usually pseudo-random; nonetheless, they can be coherent. When the analyzer components are 100 % coherent with the UUT components, the errors add in a voltage sense. That error is a function of the signal (UUT ACPR) to noise (analyzer ACPR dynamic range limitation) ratio, SN, in decibels. The function is  $\text{error} = 20 \times \log(1 + 10^{(-SN/20)})$ . For example, if the UUT ACPR is -67 dB and the measurement floor is -87 dB, the SN is 20 dB and the error due to adding the analyzer's distortion to that of the UUT is 0.83 dB.

- c. As in footnote b, the specified ACPR accuracy applies if the ACPR measured substantially exceeds the analyzer dynamic range at the specified offset. When this condition is not met, there are additional errors due to the addition of analyzer spectral components to UUT spectral components. Unlike the situation in footnote b, however, the spectral components from the analyzer will be non-coherent with the components from the UUT. Because of this, the errors add in a power sense. The error is a function of the signal (UUT ACPR) to noise (analyzer ACPR dynamic range limitation) ratio, SN, in decibels.

The function is:

$$\text{error} = 10 \times \log(1 + 10^{(-SN/10)})$$

For example, if the UUT ACPR is  $-78$  dB and the measurement floor is  $-88$  dB, the SN ratio is 10 dB and the error due to adding the analyzer's noise to that of the UUT is 0.41 dB.

cdmaOne Measurement Personality  
Option BAC, cdmaOne Measurements Personality

Description	Specifications	Supplemental Information
<b>Spur Close</b> Minimum power at RF Input Minimum spurious emission power sensitivity at RF Input <sup>a</sup> Representative Amplitude Accuracies <sup>b</sup> Example Absolute Accuracy <sup>c</sup> Example Relative Accuracy <sup>d</sup>	$\pm 0.89$ dB $\pm 0.09$ dB	-35 dBm (nominal)  -95 dBm + Input Attenuation
<b>Spectrum (Frequency Domain)</b>	See “Spectrum” on page 150.	
<b>Waveform (Time Domain)</b>	See “Waveform” on page 151.	

- a. The sensitivity is the smallest CW signal that can be reliably detected, using the 30 kHz RBW, not including the effects of phase noise.
- b. The range of possible channel powers, and levels, frequencies and spacing of spurious signals makes complete specification of amplitude uncertainty as complex as it is for any spectrum analysis measurement. The error sources for arbitrary signals are given in the “[Digital Communications Basic Measurement Personality](#)” chapter. Therefore, just two examples will be specified.
- c. The absolute power accuracy example is a base station test measuring a spurious signal at a typical specification limit of -13 dBm in a 30 kHz bandwidth 2 MHz offset from the center of the channel. The base station power is +40 dBm feed through an ideal 20 dB external attenuator. The specified accuracy excludes mismatch errors.
- d. The relative power accuracy example is a base station test measuring a spurious signal 750 kHz offset from the center of the channel, at the typical specification limit of -45 dBc in a 30 kHz bandwidth, relative to the power in the channel. The base station power is +20 dBm at the RF input.

Description	Specifications	Supplemental Information
<b>In-Band Frequency Ranges</b>	824 to 849 MHz 869 to 894 MHz  1850 to 1910 MHz 1930 to 1990 MHz	IS-95 IS-95  J-STD-008 J-STD-008



---

## **10** **cdma2000 Measurement Personality**

This chapter contains specifications for the PSA series, Option B78, cdma2000 measurement personality.

## Additional Definitions and Requirements

Because digital communications signals are noise-like, all measurements will have variations. The specifications apply only with adequate averaging to remove those variations.

The specifications apply in the frequency ranges documented in In-Band Frequency Range.

The specifications for this chapter apply to the E4440A, E4443A and E4445A spectrum analyzers. For the E4446A, E4447A, and E4448A, the performance is nominal only and not subject to any warranted specifications.

The measurement performance is only slightly different in the E4446A, E4447A, and E4448A when compared to the performance of the E4440A, E4443A and E4445A analyzers. Because the hardware performance of the analyzers is very similar but not identical, you can estimate the nominal performance of the measurements from the specifications in this chapter.

## Option B78, cdma2000 Measurement Personality

Description	Specifications	Supplemental Information
<b>Channel Power</b>		
1.23 MHz Integration BW		
Minimum power at RF input		-74 dBm (nominal)
Absolute power accuracy <sup>a</sup> 20 to 30 °C		
attenuation > 2 dB <sup>b</sup>	±0.67 dB	±0.18 dB (typical)
attenuation ≤ 2 dB	±0.76 dB	±0.24 dB (typical)
Measurement floor <sup>c</sup>		-85 dBm (nominal)
Relative power accuracy	±0.08 dB	±0.03 dB (typical)
Fixed channel		
Fixed input attenuator		
Mixer level -52 to -12 dBm <sup>d</sup>		

- a. Absolute power accuracy includes all error sources for in-band signals except mismatch errors. There are two cases listed.
- b. The absolute power accuracy depends on the setting of the electronic input attenuator as well as the signal-to-noise ratio. For high input levels, the Auto setting of RF Input Range will result in high signal-to-noise ratios and Input Atten > 2 dB, for which the absolute power accuracy is best. At moderate levels, manually setting the Input Atten can give better accuracy than the automatic setting. At very low levels, automatic or manual setting of the Input Atten to 0 dB optimizes the accuracy by maximizing the signal-to-noise ratio.  
For cdmaOne, “high levels” would nominally be levels above -14.7 dBm, and “very low levels” would nominally be below -66 dBm.  
The error due to very low signals levels is a function of the signal (channel power) to noise (measurement floor) ratio, SN, in decibels.  
The function is:  $\text{error} = 10 \times \log(1 + 10^{(-SN/10)})$   
For example, if the mixer level (input power minus attenuation) is 26.4 dB above the measurement floor, the error due to adding the analyzer's noise to the UUT is only 0.01 dB.
- c. Measurement floor is the channel power measured due only to the noise of the analyzer. It nominally changes by +1 dB/GHz for signal frequencies different from the 2 GHz frequency for which this nominal floor was determined.
- d. The relative accuracy is the ratio of the accuracy of amplitude measurements of two different transmitter power levels. Mixer level is defined to be the input power minus the attenuation. This specification is equivalent to the difference between two points on the scale fidelity curve shown in the PSA Specifications Guide. Because the error sources of scale fidelity are almost all monotonic with input level, the relative error between two levels is nearly (within 0.01 dB) identical to the “error relative to -35 dBm” specified in the Guide.

Description		Specifications	Supplemental Information
<b>Adjacent Channel Power Ratio</b>			
Minimum power at RF input			-38 dBm (nominal)
Dynamic range <sup>a</sup>			Referenced to average power of carrier in 1.23 MHz bandwidth
Offset Freq.	Integ. BW		
750 kHz	30 kHz	-84.9 dBc	Optimum mixer level <sup>b</sup> = -12 dBm
885 kHz	30 kHz	-85.2 dBc	Optimum mixer level = -12 dBm
1256.25 kHz	12.5 kHz	-89.6 dBc	Optimum mixer level = -12 dBm
1980 kHz	30 kHz	-86.8 dBc	
2750 kHz	1000 kHz	-71.7 dBc	
ACPR Relative Accuracy			
Offsets < 1300 kHz <sup>c</sup>		±0.09 dB	
Offsets > 1.85 MHz <sup>d</sup>		±0.09 dB	

- a. The optimum mixer level (mixer level is defined to be the average input power minus the input attenuation) is different for optimum ACPR dynamic range than the Auto setting of RF Input Level. For optimum dynamic range, the ideal mixer level is about -12 dBm for the 750 kHz offset, which is close to the input overload threshold. The setting for mixer level when RF Input Level is set to Auto is about -17 dBm. The advantage of the Auto setting is that it gives a greater range of allowable input peak-to-average ratios without registering an input overload
- b. These specifications apply with an apparent mixer level of -17 dBm. Mixer level is defined to be input power minus input attenuation. The apparent mixer level is different from the actual mixer level because the actual attenuation is decreased by 5 dB, compared to the attenuation shown, when measuring the adjacent channels, in order to improve dynamic range. Therefore, these specifications only apply when the input attenuation is 5 dB or more and the apparent mixer level is -17 dBm.
- c. The specified ACPR accuracy applies if the measured ACPR substantially exceeds the analyzer dynamic range at the specified offset. When this condition is not met, there are additional errors due to the addition of analyzer spectral components to UUT spectral components. In the worst case at these offsets, the analyzer spectral components are all coherent with the UUT components; in a more typical case, one third of the analyzer spectral power will be coherent with the distortion components in the UUT. Coherent means that the phases of the UUT distortion components and the analyzer distortion components are in a fixed relationship, and could be perfectly in-phase. This coherence is not intuitive to many users, because the signals themselves are usually pseudo-random; nonetheless, they can be coherent. When the analyzer components are 100 % coherent with the UUT components, the errors add in a voltage sense. That error is a function of the signal (UUT ACPR) to noise (analyzer ACPR dynamic range limitation) ratio, SN, in decibels. The function is  $\text{error} = 20 \times \log(1 + 10^{-SN/20})$ . For example, if the UUT ACPR is -62 dB and the measurement floor is -82 dB, the SN is 20 dB and the error due to adding the analyzer's distortion to that of the UUT is 0.83 dB.

d. As in footnote b, the specified ACPR accuracy applies if the ACPR measured substantially exceeds the analyzer dynamic range at the specified offset. When this condition is not met, there are additional errors due to the addition of analyzer spectral components to UUT spectral components. Unlike the situation in footnote a, though, the spectral components from the analyzer will be non-coherent with the components from the UUT. Therefore, the errors add in a power sense. The error is a function of the signal (UUT ACPR) to noise (analyzer ACPR dynamic range limitation) ratio, SN, in decibels. The function is  $\text{error} = 10 \times \log(1 + 10^{-SN/10})$ . For example, if the UUT ACPR is  $-75$  dB and the measurement floor is  $-85$  dB, the SN ratio is 10 dB and the error due to adding the analyzer's noise to that of the UUT is 0.41 dB.

Description	Specification	Supplemental Information
<b>Power Statistics CCDF</b>		
Minimum power at RF Input		$-40$ dBm (nominal)
Histogram Resolution	0.01 dB <sup>a</sup>	

a. The Complementary Cumulative Distribution Function (CCDF) is a reformatting of a histogram of the power envelope. The width of the amplitude bins used by the histogram is the histogram resolution. The resolution of the CCDF will be the same as the width of those bins.

cdma2000 Measurement Personality  
**Option B78, cdma2000 Measurement Personality**

Description	Specification	Supplemental Information
<b>Intermodulation</b> Minimum carrier power at RF Input Third-order intercept CF = 1 GHz CF = 2 GHz		-30 dBm (nominal)  TOI + 7.2 dB <sup>a</sup> TOI + 7.5 dB <sup>a</sup>

- a. The third-order intercept (TOI) of the analyzer as configured for the cdma2000 personality is higher than the third-order intercept specified for the analyzer without the personality, due to the configuration of loss elements in front of the input mixer. The personality configures the mechanical attenuator to be in a fixed 6 dB attenuation position, and has additional loss in the electronic attenuator. The TOI increases by the nominal amount shown due to these losses when the electronic attenuator is set to 0 dB, and further increases proportional to the setting of the electronic attenuator.

Description	Specification	Supplemental Information
<b>Occupied Bandwidth</b> Minimum carrier power at RF Input Frequency resolution Frequency accuracy	100 Hz	-40 dBm (nominal)  $\frac{1.2\%}{\sqrt{N_{\text{avg}}}}$ (nominal) <sup>a</sup>

- a. The errors in Occupied Bandwidth measurement are mostly due to the noisiness of any measurement of a noise-like signal, such as the cdma2000 signal. The observed standard deviation of the OBW measurement is 14 kHz (1.2 %), so with 100 averages, the standard deviation should be about 1.4 kHz, or 0.1 %.

Description	Specifications	Supplemental Information
<b>Spectrum Emission Mask</b>		
Minimum carrier power at RF Input		-20 dBm (nominal)
Dynamic Range, relative <sup>a</sup>		
750 kHz offset <sup>b</sup>	-84.7 dB	-86.4 dB (typical)
1980 MHz region <sup>c</sup>	-80.7 dB	-83.0 dB (typical)
Sensitivity, absolute <sup>d</sup>		
750 kHz offset <sup>e</sup>	-97.9 dBm	-99.9 dBm (typical)
1980 MHz region <sup>f</sup>	-81.9 dBm	-83.9 dBm (typical)
Accuracy, relative		
750 kHz offset <sup>g</sup>	±0.14 dB	
1980 MHz region <sup>h</sup>	±0.56 dB	

- a. The dynamic range specification is the ratio of the channel power to the power in the offset and region specified. The dynamic range depends on the measurement settings, such as peak power or integrated power. This specification is derived from other analyzer performance limitations such as third-order intermodulation, DANL and phase noise. Dynamic range specifications are based on default measurement settings, with detector set to average, and depend on the mixer level. Mixer level is defined to be the input power minus the input attenuation.
- b. Default measurement settings include 30 kHz RBW. This dynamic range specification applies for the optimum mixer level, which is about -11 dBm.
- c. Default measurement settings include 1200 kHz RBW. This dynamic range specification applies for a mixer level of 0 dBm. Higher mixer levels can give up to 5 dB better dynamic range, but at the expense of compression in the input mixer, which reduces accuracy. The compression behavior of the input mixer is specified in the PSA Specifications Guide; the levels into the mixer are nominally 8 dB lower in this application when the center frequency is 2 GHz.
- d. The sensitivity is specified with 0 dB input attenuation. It represents the noise limitations of the analyzer. It is tested without an input signal.
- e. The sensitivity at this offset is specified for the default 30 kHz RBW, at a center frequency of 2 GHz.
- f. The sensitivity for this region is specified for the default 1200 kHz bandwidth, at a center frequency of 2 GHz.
- g. The relative accuracy is a measure of the ratio of the power at the offset to the main channel power. It applies for spectrum emission levels in the offsets that are well above the dynamic range limitation.
- h. The relative accuracy is a measure of the ratio of the power in the region to the main channel power. It applies for spurious emission levels in the regions that are well above the dynamic range limitation.

Description	Specifications	Supplemental Information
<p><b>Code Domain</b></p> <p>Code domain power</p> <p>Power range at RF input Preamplifier On</p> <p>The following specifications are applicable with the Preamplifier (Option 1DS) Off.</p> <p>Code domain power</p> <p>Minimum power at RF input</p> <p>Relative power accuracy</p> <p>Code domain power range</p> <p>0 to -10 dBc</p> <p>-10 to -30 dBc</p> <p>-30 to -40 dBc</p> <p>Symbol power vs. time</p> <p>Minimum power at RF Input</p> <p>Accuracy</p> <p>Symbol error vector magnitude</p> <p>Minimum power at RF Input Accuracy</p>	<p></p> <p></p> <p></p> <p></p> <p></p> <p></p> <p><math>\pm 0.015</math> dB</p> <p><math>\pm 0.18</math> dB</p> <p><math>\pm 0.51</math> dB</p> <p></p> <p></p> <p><math>\pm 0.1</math> dB</p> <p></p> <p></p> <p><math>\pm 0.1</math> %</p>	<p>Specifications apply to BTS for 9 active channels as defined in 3GPP2, and where the mixer level (RF input power minus attenuation) is between -25 and -15 dBm.</p> <p>-80 to -40 dBm (nominal)<sup>a</sup></p> <p>-60 dBm (nominal)<sup>b c</sup></p> <p></p> <p>-40 dBm (nominal)<sup>b c</sup></p> <p>Specified for code channel power <math>\geq -20</math> dBc</p> <p></p> <p>-20 dBm (nominal)<sup>b c</sup></p>

- a. Pilot synchronization requires a minimum RF input power of -80 dBm. Pilot synchronization can be obtained above -40 dBm, but TOI products will begin to raise the code domain noise floor. The power range that is free from TOI-induced noise floor problems can be extended up to 20 dB by increasing the input attenuation above the factory preset setting of 0 dB when using the preamplifier. There is no auto mode for setting input attenuation when the preamplifier is On.
- b. At low signal-to-noise ratios where the RF input power is below -65 dBm, the auto channel ID algorithm may not accurately detect an active code channel as turned on.
- c. Nominal operating range. Accuracy specification applies when mixer level (RF input power minus attenuation) is between -25 and -15 dBm.



Description	Specifications	Supplemental Information
<p><b>QPSK EVM</b></p> <p>Minimum power at RF input  Preamplifier (<i>Option 1DS</i>) Off, except as noted</p> <p>EVM  Operating range</p> <p>Floor  Preamplifier (<i>Option 1DS</i>) Off  Preamplifier (<i>Option 1DS</i>) On</p> <p>Accuracy <sup>a</sup></p> <p>I/Q origin offset  DUT Maximum Offset  Analyzer Noise Floor</p> <p>Frequency Error  Range</p> <p>Accuracy</p>	<p>1.5 %</p>	<p>–20 dBm (nominal)</p> <p>0 to 18 % (nominal)</p> <p>1.5 % (nominal)</p> <p>RF input power = –50 dBm,  Attenuator = 0 dB</p> <p>±1.0 % (nominal)</p> <p>–10 dBc (nominal)  –45 dBc (nominal)</p> <p>±5.0 kHz (nominal)</p> <p>±10 Hz + tfa <sup>b</sup></p>

- a. The accuracy specification applies when the EVM to be measured is well above the measurement floor. When the EVM does not greatly exceed the floor, the errors due to the floor add to the accuracy errors. The errors due to the floor are noise-like and add incoherently with the UUT EVM. The errors depend on the EVM of the UUT and the floor as follows:  $\text{error} = \sqrt{\text{EVMUUT}^2 + \text{EVMsa}^2} - \text{EVMUUT}$ , where EVMUUT is the EVM of the UUT in percent, and EVMsa is the EVM floor of the analyzer in percent. For example, if the EVM of the UUT is 7 %, and the floor is 2.5 %, the error due to the floor is 0.43 %. The total error can cause a reading as high as  $\text{EVMUUT} + \text{floorerror} + \text{accyerror}$ , or as low as  $\text{EVMUUT} - \text{accyerror}$ , where floorerror is the result of the error computation due to the floor, and accyerror is the specified accuracy.
- b. tfa = transmitter frequency × frequency reference accuracy

Description	Specifications	Supplemental Information
<b>Modulation Accuracy (Composite Rho)</b>		Specifications apply to BTS for 9 active channels as defined in 3GPP2, and where the mixer level (RF input power minus attenuation) is between –25 and –15 dBm.
Power range at RF Input Preamplifier (Option 1DS) On		–80 to –40 dBm (nominal) <sup>a</sup>
Minimum power at RF Input Preamplifier (Option 1DS) Off		–60 dBm (nominal) <sup>b c</sup>
All remaining Modulation Accuracy specifications are applicable with the Preamplifier (Option 1DS) Off.		
Global EVM		
Range	0 to 25 %	
Floor	1.5 %	
Accuracy <sup>d</sup>	±0.75 %	
Rho		
Range	0.9 to 1.0	
Floor	0.99978	
Accuracy	±0.0010	at Rho 0.99751 (EVM 5 %)
	±0.0035	at Rho 0.94118 (EVM 25 %)

- a. Pilot synchronization requires a minimum RF input power of –80 dBm. Pilot synchronization can be obtained above –40 dBm, but TOI products will begin to raise the EVM floor. The power range that is free from TOI-induced noise floor problems can be extended up to 20 dB by increasing the input attenuation above the factory preset setting of 0 dB when using the preamplifier. There is no auto mode for setting input attenuation when the preamplifier is On.
- b. At low signal-to-noise ratios where the RF input power is below –65 dBm, the auto channel ID algorithm may not accurately detect an active code channel as turned on.
- c. Nominal operating range. Accuracy specification applies when mixer level (RF input power minus attenuation) is between –25 and –15 dBm.
- d. The accuracy specification applies when the EVM to be measured is well above the measurement floor. When the EVM does not greatly exceed the floor, the errors due to the floor add to the accuracy errors. The errors due to the floor are noise-like and add incoherently with the UUT EVM. The errors depend on the EVM of the UUT and the floor as follows:  $\text{floorerror} = \sqrt{\text{EVMUUT}^2 + \text{EVMsa}^2} - \text{EVMUUT}$ , where EVMUUT is the EVM of the UUT in percent, and EVMsa is the EVM floor of the analyzer in percent. For example, if the EVM of the UUT is 7 %, and the floor is 2.5 %, the error due to the floor is 0.43 %. The total error can cause a reading as high as  $\text{EVMUUT} + \text{floorerror} + \text{accyerror}$ , or as low as  $\text{EVMUUT} - \text{accyerror}$ , where floorerror is the result of the error computation due to the floor, and accyerror is the specified accuracy.

Description	Specifications	Supplemental Information
Pilot time offset Range	-13.33 to +13.33 ms	From even second signal to start of PN sequence
Accuracy	±300 ns	
Resolution	10 ns	
Code domain timing Range	±200 ns	Pilot to code channel time tolerance
Accuracy	±1.25 ns	
Resolution	0.1 ns	
Code domain phase Range	±200 mrad	Pilot to code channel phase tolerance
Accuracy	±10 mrad	
Resolution	0.1 mrad	
Peak code domain error Accuracy		±1.0 dB (nominal)
I/Q origin offset DUT Maximum Offset Analyzer Noise Floor		-10 dBc (nominal) -50 dBc (nominal)
Frequency error Range	±900 Hz	
Accuracy	±10 Hz + tfa <sup>a</sup>	
<b>Spectrum (Frequency Domain)</b>	See “Spectrum” on page 150.	
<b>Waveform (Time Domain)</b>	See “Waveform” on page 151.	

a. tfa = transmitter frequency × frequency reference accuracy

Description	Specifications	Supplemental Information
<b>In-Band Frequency Range</b> Band Class 0 (North American Cellular)	869 to 894 MHz 824 to 849 MHz	
Band Class 1 (North American PCS)	1930 to 1990 MHz 1850 to 1910 MHz	
Band Class 2 (TACS)	917 to 960 MHz 872 to 915 MHz	

cdma2000 Measurement Personality  
Option B78, cdma2000 Measurement Personality

Description	Specifications	Supplemental Information
Band Class 3 (JTACS)	832 to 870 MHz 887 to 925 MHz	
Band Class 4 (Korean PCS)	1840 to 1870 MHz 1750 to 1780 MHz	
Band Class 6 (IMT-2000)	2110 to 2170 MHz 1920 to 1980 MHz	

**General**

Description	Specifications	Supplemental Information
<b>Trigger</b>		
Trigger source		RF burst (wideband), Video (IF envelope), Ext Front, Ext Rear. Actual available choices are dependent on measurement.
Trigger delay, level, and slope		Each trigger source has a separate set of these parameters.
Trigger delay		
Range	-100 to +500 ms	
Repeatability	±33 ns	
Resolution	33 ns	
External trigger inputs		
Level		-5 V to +5 V (nominal)
Impedance		10 kW (nominal)
<b>Range Control</b>		RF Input Autorange <sup>a</sup>
		Manually set <b>Max Total Pwr</b>
		Manually set <b>Input Atten</b>

a. Auto range is *not* continuous with each measurement acquisition; it will run only once immediately following a measurement restart, initiated either by pressing the **Restart** key, or by sending the GPIB command `INIT:IMM`. This behavior was chosen to maintain best measurement speed, but it requires caution when input power levels change. If the input signal power changes, the analyzer will not readjust the input attenuators for optimal dynamic range unless a measurement restart is initiated. For example, if a sequence of power measurements is made, beginning with a maximum power level that is large enough to require non-zero input attenuation, it is advisable to do a measurement restart to automatically set a lower input attenuator value to maintain optimal dynamic range for approximately every 3 dB the input signal power level is reduced, or smaller, depending upon how precisely dynamic range needs to be optimized. Conversely, if the input signal power increases to a high enough level, input overloading will occur if the input attenuators are not readjusted by doing a measurement restart.



---

## **11** **1xEV-DV Measurement Personality**

This chapter contains specifications for the PSA series, Option 214, 1xEV-DV measurement personality.

## Additional Definitions and Requirements

Because digital communications signals are noise-like, all measurements will have variations. The specifications apply only with adequate averaging to remove those variations.

The specifications apply in the frequency ranges documented in In-Band Frequency Range.

The specifications for this chapter apply to the E4440A, E4443A and E4445A spectrum analyzers. For the E4446A, E4447A, and E4448A, the performance is nominal only and not subject to any warranted specifications.

The measurement performance is only slightly different in the E4446A, E4447A, and E4448A when compared to the performance of the E4440A, E4443A and E4445A analyzers. Because the hardware performance of the analyzers is very similar but not identical, you can estimate the nominal performance of the measurements from the specifications in this chapter.



## Test model signal for 1xEV-DV

3GPP2 defines the test model signal as 9 active channels for a cdma2000 forward link. However, it doesn't cover 1xEV-DV requirements. This means that we need to define the test signal with an appropriate configuration for our specifications in Code Domain and Mod Accuracy. For the 1xEV-DV 8PSK/16QAM modulation code signal, we define the test model signal with the following table.

**Table 11-1 Test Model Definition for 1xEV-DV:**

	Walsh	Code#	N	Power	
				Linear	dB
Pilot	64	0	1	0.200	-7.0
Paging	64	1	1	0.338	-4.7
Sync	64	32	1	0.085	-10.7
F-FCH	64	8	1	0.169	-7.7
F-PDCCH	64	9	1	0.039	-14.0
F-PDCH	32	31	1	0.039	-14.0
F-PDCH	32	15	1	0.039	-14.0
F-PDCH	32	23	1	0.039	-14.0
F-PDCH	32	7	1	0.039	-14.0
F-PDCH	32	27	1	0.039	-14.0
F-PDCH	32	11	1	0.039	-14.0
F-PDCH	32	19	1	0.039	-14.0
F-PDCH	32	3	1	0.039	-14.0
F-PDCH	32	30	1	0.039	-14.0
F-PDCH	32	14	1	0.039	-14.0
F-PDCH	32	22	1	0.039	-14.0
F-PDCH	32	6	1	0.039	-14.0
F-PDCH	32	26	1	0.039	-14.0
F-PDCH	32	10	1	0.039	-14.0
F-PDCH	32	18	1	0.039	-14.0

## Option 214, 1xEV-DV Measurement Personality

Description	Specifications	Supplemental Information
<p><b>Code Domain</b></p> <p>Code domain power</p> <p>Power range at RF input</p> <p>Preamplifier On</p> <p>The following specifications are applicable with the Preamplifier (<i>Option IDS</i>) Off.</p> <p>Code domain power</p> <p>Minimum power at RF input</p> <p>Relative power accuracy</p> <p>QPSK modulation code signal</p> <p>Code domain power range</p> <p>0 to -10 dBc</p> <p>-10 to -30 dBc</p> <p>-30 to -40 dBc</p> <p>8PSK/16QAM modulation code signal</p> <p>Code domain power range</p> <p>0 to -10 dBc</p> <p>-10 to -30 dBc</p> <p>-30 to -40 dBc</p>	<p><math>\pm 0.015</math> dB</p> <p><math>\pm 0.18</math> dB</p> <p><math>\pm 0.51</math> dB</p>	<p>Specifications apply to BTS for 9 active channels as defined in 3GPP2 unless otherwise stated, and where the mixer level (RF input power minus attenuation) is between -25 and -15 dBm.</p> <p>-80 to -40 dBm (nominal)<sup>a</sup></p> <p>-60 dBm (nominal)<sup>b c</sup></p> <p>See the table in <a href="#">Test model signal for 1xEV-DV on page 225</a></p> <p><math>\pm 0.015</math> dB (nominal)</p> <p><math>\pm 0.18</math> dB (nominal)</p> <p><math>\pm 0.51</math> dB (nominal)</p>

- a. Pilot synchronization requires a minimum RF input power of -80 dBm. Pilot synchronization can be obtained above -40 dBm, but TOI products will begin to raise the code domain noise floor. The power range that is free from TOI-induced noise floor problems can be extended up to 20 dB by increasing the input attenuation above the factory preset setting of 0 dB when using the preamplifier. There is no auto mode for setting input attenuation when the preamplifier is On.
- b. At low signal-to-noise ratios where the RF input power is below -65 dBm, the auto channel ID algorithm may not accurately detect an active code channel as turned on.
- c. Nominal operating range. Accuracy specification applies when mixer level (RF input power minus attenuation) is between -25 and -15 dBm.

Description	Specifications	Supplemental Information
Symbol power vs. time Minimum power at RF Input QPSK modulation code signal Accuracy 8PSK/16QAM modulation code signal Accuracy Symbol error vector magnitude Minimum power at RF Input Accuracy	±0.1 dB      ±0.10 %	–40 dBm (nominal) <sup>a b</sup> For code channel power ≥ –20 dBc  See <a href="#">Test model signal for 1xEV-DV on page 225</a> ±0.1 dB (nominal)  –20 dBm (nominal)

- a. Pilot synchronization requires a minimum RF input power of –80 dBm. Pilot synchronization can be obtained above –40 dBm, but TOI products will begin to raise the code domain noise floor. The power range that is free from TOI-induced noise floor problems can be extended up to 20 dB by increasing the input attenuation above the factory preset setting of 0 dB when using the preamplifier. There is no auto mode for setting input attenuation when the preamplifier is On.
- b. At low signal-to-noise ratios where the RF input power is below –65 dBm, the auto channel ID algorithm may not accurately detect an active code channel as turned on.

1xEV-DV Measurement Personality  
**Option 214, 1xEV-DV Measurement Personality**

Description	Specifications	Supplemental Information
<p><b>Modulation Accuracy (Composite Rho)</b></p> <p>Power range at RF Input  Pre-amplifier (<i>Option 1DS</i>) On</p> <p>Minimum power at RF Input  Pre-amplifier (<i>Option 1DS</i>) Off</p> <p>All remaining Modulation Accuracy specifications are applicable with the Pre-amplifier (<i>Option 1DS</i>) Off.</p> <p>Global EVM</p> <p>Range</p> <p>Floor</p> <p>Accuracy<sup>d</sup></p> <p>Rho</p> <p>Range</p> <p>Floor</p> <p>Accuracy</p>	<p>0 to 25 %</p> <p>1.5 %</p> <p>±0.75 %</p> <p>0.9 to 1.0</p> <p>0.99978</p> <p>±0.0010</p> <p>±0.0035</p>	<p>Specifications apply to BTS for 9 active channels as defined in 3GPP2 unless otherwise stated, and where the mixer level (RF input power minus attenuation) is between –25 and –15 dBm.</p> <p>–80 to –40 dBm (nominal)<sup>a</sup></p> <p>–60 dBm (nominal)<sup>b c</sup></p> <p>At Rho 0.99751 (EVM 5 %)</p> <p>At Rho 0.94118 (EVM 25 %)</p>

- a. Pilot synchronization requires a minimum RF input power of –80 dBm. Pilot synchronization can be obtained above –40 dBm, but TOI products will begin to raise the EVM floor. The power range that is free from TOI-induced noise floor problems can be extended up to 20 dB by increasing the input attenuation above the factory preset setting of 0 dB when using the preamplifier. There is no auto mode for setting input attenuation when the preamplifier is On.
- b. At low signal-to-noise ratios where the RF input power is below –65 dBm, the auto channel ID algorithm may not accurately detect an active code channel as turned on.
- c. Nominal operating range. Accuracy specification applies when mixer level (RF input power minus attenuation) is between –25 and –15 dBm.

- d. The accuracy specification applies when the EVM to be measured is well above the measurement floor. When the EVM does not greatly exceed the floor, the errors due to the floor add to the accuracy errors. The errors due to the floor are noise-like and add incoherently with the UUT EVM. The errors depend on the EVM of the UUT and the floor as follows:  $\text{floorerror} = \sqrt{\text{EVMUUT}^2 + \text{EVMsa}^2} - \text{EVMUUT}$ , where EVMUUT is the EVM of the UUT in percent, and EVMsa is the EVM floor of the analyzer in percent. For example, if the EVM of the UUT is 7 %, and the floor is 2.5 %, the error due to the floor is 0.43 %. The total error can cause a reading as high as  $\text{EVMUUT} + \text{floorerror} + \text{accyerror}$ , or as low as  $\text{EVMUUT} - \text{accyerror}$ , where floorerror is the result of the error computation due to the floor, and accyerror is the specified accuracy.

Description	Specifications	Supplemental Information
The following specifications for Global EVM and Rho apply for the test model signal for 1xEV-DV defined above.		See the table in <a href="#">Test model signal for 1xEV-DV on page 225</a>
Global EVM		
Range		0 to 25 % (nominal)
Floor		1.5 % (nominal)
Accuracy <sup>a</sup>		±0.75 % (nominal)
Rho		
Range		0.9 to 1.0 (nominal)
Floor		0.99978 (nominal)
Accuracy		±0.0010 (nominal) at Rho 0.99751 (EVM 5 %) ±0.0035 (nominal) at Rho 0.94118 (EVM 25 %)
Pilot time offset		From even second signal to start of PN sequence
Range	-13.33 to +13.3 ms	
Accuracy	±300 ns	
Resolution	10 ns	
Code domain timing		Pilot to code channel time tolerance
Range	±200 ns	
Accuracy	±1.25 ns	
Resolution	0.1 ns	

1xEV-DV Measurement Personality  
**Option 214, 1xEV-DV Measurement Personality**

Description	Specifications	Supplemental Information
Code domain phase		Pilot to code channel phase tolerance
Range	±200 mrad	
Accuracy	±10 mrad	
Resolution	0.1 mrad	

- a. The accuracy specification applies when the EVM to be measured is well above the measurement floor. When the EVM does not greatly exceed the floor, the errors due to the floor add to the accuracy errors. The errors due to the floor are noise-like and add incoherently with the UUT EVM. The errors depend on the EVM of the UUT and the floor as follows:  $\text{floorerror} = \sqrt{\text{EVMUUT}^2 + \text{EVMsa}^2} - \text{EVMUUT}$ , where EVMUUT is the EVM of the UUT in percent, and EVMsa is the EVM floor of the analyzer in percent. For example, if the EVM of the UUT is 7 %, and the floor is 2.5 %, the error due to the floor is 0.43 %. The total error can cause a reading as high as  $\text{EVMUUT} + \text{floorerror} + \text{accyerror}$ , or as low as  $\text{EVMUUT} - \text{accyerror}$ , where floorerror is the result of the error computation due to the floor, and accyerror is the specified accuracy.

Description	Specifications	Supplemental Information
Peak code domain error		
Accuracy		
9 active channels		±1.0 dB (nominal)
Test model signal for 1xEV-DV See <a href="#">Test model signal for 1xEV-DV on page 225</a>		±1.0 dB (nominal)

Description	Specifications	Supplemental Information
I/Q origin offset DUT Maximum Offset Analyzer Noise Floor		-10 dBc (nominal) -50 dBc (nominal)
Frequency error Range Accuracy	$\pm 900$ Hz $\pm 10$ Hz + tfa <sup>a</sup>	
<b>Spectrum (Frequency Domain)</b>	See “Spectrum” on page 150.	
<b>Waveform (Time Domain)</b>	See “Waveform” on page 151.	

a. tfa = transmitter frequency × frequency reference accuracy

Description	Specifications	Supplemental Information
<b>In-Band Frequency Range</b>		
Band Class 0 (North American Cellular)	869 to 894 MHz 824 to 849 MHz	
Band Class 1 (North American PCS)	1930 to 1990 MHz 1850 to 1910 MHz	
Band Class 2 (TACS)	917 to 960 MHz 872 to 915 MHz	
Band Class 3 (JTACS)	832 to 870 MHz 887 to 925 MHz	
Band Class 4 (Korean PCS)	1840 to 1870 MHz 1750 to 1780 MHz	
Band Class 6 (IMT-2000)	2110 to 2170 MHz 1920 to 1980 MHz	

## General

Description	Specifications	Supplemental Information
<b>Trigger</b>		
Trigger source		RF burst (wideband), Video (IF envelope), Ext Front, Ext Rear. Actual available choices are dependent on measurement.
Trigger delay, level, and slope		Each trigger source has a separate set of these parameters.
Trigger delay		
Range	-100 to +500 ms	
Repeatability	±33 ns	
Resolution	33 ns	
External trigger inputs		
Level		-5 V to +5 V (nominal)
Impedance		10 kW (nominal)
<b>Range Control</b>		RF Input Autorange <sup>a</sup> Manually set <b>Max Total Pwr</b> Manually set <b>Input Atten</b>

- a. Auto range is not continuous with each measurement acquisition; it will run only once immediately following a measurement restart, initiated either by pressing the Restart key, or by sending the GPIB command INIT:IMM. This behavior was chosen to maintain best measurement speed, but it requires caution when input power levels change. If the input signal power changes, the analyzer will not readjust the input attenuators for optimal dynamic range unless a measurement restart is initiated. For example, if a sequence of power measurements is made, beginning with a maximum power level that is large enough to require non-zero input attenuation, it is advisable to do a measurement restart to automatically set a lower input attenuator value to maintain optimal dynamic range for approximately every 3 dB the input signal power level is reduced, or smaller, depending upon how precisely dynamic range needs to be optimized. Conversely, if the input signal power increases to a high enough level, input overloading will occur if the input attenuators are not readjusted by doing a measurement restart.



---

## **12** **1xEV-DO Measurement Personality**

This chapter contains specifications for the PSA series, *Option 204*, 1xEV-DO measurement personality.

## Additional Definitions and Requirements

Because digital communications signals are noise-like, all measurements will have variations. The specifications apply only with adequate averaging to remove those variations.

The specifications apply in the frequency ranges documented in In-Band Frequency Range.

The specifications for this chapter apply to the E4440A, E4443A and E4445A spectrum analyzers. For the E4446A, E4447A, and E4448A, the performance is nominal only and not subject to any warranted specifications.

The measurement performance is only slightly different in the E4446A, E4447A, and E4448A when compared to the performance of the E4440A, E4443A and E4445A analyzers. Because the hardware performance of the analyzers is very similar but not identical, you can estimate the nominal performance of the measurements from the specifications in this chapter.

## Option 204,1xEV-DO Measurements Personality

Description	Specifications	Supplemental Information
<b>Channel Power</b>		Input signal must not be bursted
1.23 MHz Integration BW		
Minimum power at RF input		-74 dBm (nominal)
Absolute power accuracy <sup>a</sup> 20 to 30 °C		
attenuation > 2 dB <sup>b</sup>	±0.67 dB	±0.18 dB (typical)
attenuation ≤ 2 dB	±0.76 dB	±0.24 dB (typical)
Measurement floor <sup>c</sup>		-85 dBm (nominal)
Relative power accuracy	±0.08 dB	±0.03 dB (typical)
Fixed channel		
Fixed input attenuator		
Mixer level -52 to -12 dBm <sup>d</sup>		

- a. Absolute power accuracy includes all error sources for in-band signals except mismatch errors. There are two cases listed.
- b. The absolute power accuracy depends on the setting of the electronic input attenuator as well as the signal-to-noise ratio. For high input levels, the Auto setting of RF Input Range will result in high signal-to-noise ratios and Input Atten > 2 dB, for which the absolute power accuracy is best. At moderate levels, manually setting the Input Atten can give better accuracy than the automatic setting. At very low levels, automatic or manual setting of the Input Atten to 0 dB optimizes the accuracy by maximizing the signal-to-noise ratio.  
For cdmaOne, “high levels” would nominally be levels above -14.7 dBm, and “very low levels” would nominally be below -66 dBm.  
The error due to very low signals levels is a function of the signal (channel power) to noise (measurement floor) ratio, SN, in decibels.  
The function is:

$$\text{error} = 10 \times \log (1 + 10^{-SN/10})$$

- For example, if the mixer level (input power minus attenuation) is 26.4 dB above the measurement floor, the error due to adding the analyzer's noise to the UUT is only 0.01 dB.
- c. Measurement floor is the channel power measured due only to the noise of the analyzer. The measurement floor nominally changes by +1 dB/GHz for signal frequencies different from the 2 GHz frequency for which this nominal floor was determined.
- d. The relative accuracy is the ratio of the accuracy of amplitude measurements of two different transmitter power levels. Mixer level is defined to be the input power minus the attenuation. This specification is equivalent to the difference between two points on the scale fidelity curve shown in the PSA Specifications Guide. Because the error sources of scale fidelity are almost all monotonic with input level, the relative error between two levels is nearly (within 0.01 dB) identical to the “error relative to -35 dBm” specified in the Guide.

1xEV-DO Measurement Personality  
Option 204, 1xEV-DO Measurements Personality

Description	Specifications	Supplemental Information
<b>Power Statistics CCDF</b> Minimum power at RF Input Histogram Resolution	0.01 dB <sup>a</sup>	-40 dBm (nominal)

- a. The Complementary Cumulative Distribution Function (CCDF) is a reformatting of a histogram of the power envelope. The width of the amplitude bins used by the histogram is the histogram resolution. The resolution of the CCDF will be the same as the width of those bins.

Description	Specifications	Supplemental Information
<b>Intermod</b> Minimum carrier power at RF Input Third-order intercept CF = 1 GHz CF = 2 GHz		Input signal must not be bursted -30 dBm (nominal) TOI + 7.2 dB <sup>a</sup> TOI + 7.5 dB <sup>a</sup>

- a. The third-order intercept (TOI) of the analyzer as configured for the cdma2000 personality is higher than the third-order intercept specified for the analyzer without the personality, due to the configuration of loss elements in front of the input mixer. The personality configures the mechanical attenuator to be in a fixed 6 dB attenuation position, and has additional loss in the electronic attenuator. The TOI increases by the nominal amount shown due to these losses when the electronic attenuator is set to 0 dB, and further increases proportional to the setting of the electronic attenuator.

Description	Specifications	Supplemental Information
<b>Occupied Bandwidth</b> Minimum carrier power a RF Input Frequency resolution Frequency accuracy	100 Hz	Input signal must not be bursted -40 dBm (nominal) $\frac{1.2\%}{\sqrt{N_{avg}}}$ (nominal) <sup>a</sup>

- a. The errors in Occupied Bandwidth measurement are mostly due to the noisiness of any measurement of a noise-like signal, such as the 1xEV signal. The observed standard deviation of the OBW measurement is 14 kHz (1.2 %), so with 100 averages, the standard deviation should be about 1.4 kHz, or 0.1 %.

Description	Specifications	Supplemental Information
<b>Spurious Emissions and ACP</b>		
Minimum carrier power a RF Input		-20 dBm (nominal)
Dynamic Range, relative <sup>a</sup>		
750 kHz offset <sup>b</sup>	-84.7 dB	-86.4 dB (typical)
1.980 MHz region <sup>c</sup>	-80.7 dB	-83.0 dB (typical)
Sensitivity, absolute <sup>d</sup>		
750 kHz offset <sup>e</sup>	-97.9 dBm	-99.9 dBm (typical)
1.980 MHz region <sup>f</sup>	-81.9 dBm	-83.9 dBm (typical)
Accuracy, relative		
750 kHz offset <sup>g</sup>	±0.14 dB	
1.980 MHz region <sup>h</sup>	±0.56 dB	

- a. The dynamic range specification is the ratio of the channel power to the power in the offset and region specified. The dynamic range depends on the measurement settings, such as peak power or integrated power. This specification is derived from other analyzer performance limitations such as third-order intermodulation, DANL and phase noise. Dynamic range specifications are based on default measurement settings, with detector set to average, and depend on the mixer level. Mixer level is defined to be the input power minus the input attenuation.
- b. Default measurement settings include 30 kHz RBW. This dynamic range specification applies for the optimum mixer level, which is about -11 dBm.
- c. Default measurement settings include 1200 kHz RBW. This dynamic range specification applies for a mixer level of 0 dBm. Higher mixer levels can give up to 5 dB better dynamic range, but at the expense of compression in the input mixer, which reduces accuracy. The compression behavior of the input mixer is specified in the PSA Specifications Guide; the levels into the mixer are nominally 8 dB lower in this application when the center frequency is 2 GHz.
- d. The sensitivity is specified with 0 dB input attenuation. It represents the noise limitations of the analyzer. It is tested without an input signal.
- e. The sensitivity at this offset is specified for the default 30 kHz RBW, at a center frequency of 2 GHz.
- f. The sensitivity for this region is specified for the default 1200 kHz bandwidth, at a center frequency of 2 GHz.
- g. The relative accuracy is a measure of the ratio of the power at the offset to the main channel power. It applies for spectrum emission levels in the offsets that are well above the dynamic range limitation.
- h. The relative accuracy is a measure of the ratio of the power in the region to the main channel power. It applies for spurious emission levels in the regions that are well above the dynamic range limitation.

1xEV-DO Measurement Personality  
Option 204, 1xEV-DO Measurements Personality

Description	Specifications	Supplemental Information
<b>Code Domain</b> Specification applies at 0 dBm input power. Relative power accuracy	±0.15 dB	For Pilot, 2 MAC channels, and 16 channels of QPSK data

Description	Specifications	Supplemental Information
<b>QPSK EVM</b> Minimum power at RF input EVM Operating range Floor Accuracy <sup>a</sup> I/Q origin offset DUT Maximum Offset Analyzer Noise Floor Frequency Error Range Accuracy		-20 dBm (nominal) 0 to 15 % (nominal) 1.5 % (nominal) ±1.0 % (nominal) -10 dBc (nominal) -50 dBc (nominal) ±5.0 kHz (nominal) ±10 Hz (nominal) + tfa <sup>b</sup>

- a. The accuracy specification applies when the EVM to be measured is well above the measurement floor. When the EVM does not greatly exceed the floor, the errors due to the floor add to the accuracy errors. The errors due to the floor are noise-like and add incoherently with the UUT EVM. The errors depend on the EVM of the UUT and the floor as follows:  $\text{error} = \sqrt{\text{EVM}_{\text{UUT}}^2 + \text{EVM}_{\text{sa}}^2} - \text{EVM}_{\text{UUT}}$ , where  $\text{EVM}_{\text{UUT}}$  is the EVM of the UUT in percent, and  $\text{EVM}_{\text{sa}}$  is the EVM floor of the analyzer in percent. For example, if the EVM of the UUT is 7 %, and the floor is 2.5 %, the error due to the floor is 0.43 %. The total error can cause a reading as high as  $\text{EVM}_{\text{UUT}} + \text{floorerror} + \text{accyerror}$ , or as low as  $\text{EVM}_{\text{UUT}} - \text{accyerror}$ , where floorerror is the result of the error computation due to the floor, and accyerror is the specified accuracy.
- b. tfa = transmitter frequency × frequency reference accuracy



1xEV-DO Measurement Personality  
Option 204, 1xEV-DO Measurements Personality

Description	Specifications	Supplemental Information
<p><b>Power vs. Time (PvT)</b></p> <p>Minimum power at RF input</p> <p>Absolute power accuracy <sup>a</sup> 20 to 30 °C attenuation &gt; 2 dB<sup>b</sup> attenuation ≤ 2 dB</p> <p>Measurement floor <sup>c</sup></p> <p>Relative power accuracy Fixed channel Fixed input attenuator Mixer level –52 to –12 dBm <sup>d</sup></p>		<p>–73 dBm (nominal)</p> <p>±0.24 dB (nominal) ±0.30 dB (nominal)</p> <p>–84 dBm (nominal)</p> <p>±0.03 dB (nominal)</p>
<b>Spectrum (Frequency Domain)</b>	See “Spectrum” on page 150.	
<b>Waveform (Time Domain)</b>	See “Waveform” on page 151.	

- a. Absolute power accuracy includes all error sources for in-band signals except mismatch errors. There are two cases listed.
- b. The absolute power accuracy depends on the setting of the electronic input attenuator as well as the signal-to-noise ratio. For high input levels, the Auto setting of RF Input Range will result in high signal-to-noise ratios and Input Atten > 2 dB, for which the absolute power accuracy is best. At moderate levels, manually setting the Input Atten can give better accuracy than the automatic setting. At very low levels, automatic or manual setting of the Input Atten to 0dB optimizes the accuracy by maximizing the signal-to-noise ratio.  
For cdmaOne, “high levels” would nominally be levels above –14.7 dBm, and “very low levels” would nominally be below –66 dBm.  
The error due to very low signals levels is a function of the signal (channel power) to noise (measurement floor) ratio, SN, in decibels.  
The function is:  

$$\text{error} = 10 \times \log(1 + 10^{(-SN/10)})$$
For example, if the mixer level (input power minus attenuation) is 26.4 dB above the measurement floor, the error due to adding the analyzer's noise to the UUT is only 0.01 dB.
- c. Measurement floor is the channel power measured due only to the noise of the analyzer. The measurement floor nominally changes by +1 dB/GHz for signal frequencies different from the 2 GHz frequency for which this nominal floor was determined.
- d. The relative accuracy is the ratio of the accuracy of amplitude measurements of two different transmitter power levels. Mixer level is defined to be the input power minus the attenuation. This specification is equivalent to the difference between two points on the scale fidelity curve shown in the PSA Specifications Guide. Because the error sources of scale fidelity are almost all monotonic with input level, the relative error between two levels is nearly (within 0.01 dB) identical to the “error relative to –35 dBm” specified in the Guide.



## Frequency

Description	Specifications	Supplemental Information
<b>In-Band Frequency Range</b>		
(Access Network Only)		
Band Class 0	869 to 894 MHz	North American and Korean Cellular Bands
Band Class 1	1930 to 1990 MHz	North American PCS Band
Band Class 2	917 to 960 MHz	TACS Band
Band Class 3	832 to 869 MHz	JTACS Band
Band Class 4	1840 to 1870 MHz	Korean PCS Band
Band Class 6	2110 to 2170 MHz	IMT-2000 Band
Band Class 8	1805 to 1880 MHz	1800-MHz Band
Band Class 9	925 to 960 MHz	900-MHz Band

---

## Alternative Frequency Ranges

Description	Specifications	Supplemental Information
<b>Alternative Frequency Ranges<sup>a</sup></b> (Access Network Only)		
Band Class 5	421 to 430 MHz 460 to 470 MHz 489 to 194 MHz	NMT-450 Band
Band Class 7	746 to 764 MHz	North American 700-MHz Cellular Band

- a. Frequency ranges with tuning plans but degraded specifications for absolute power accuracy. The degradation should be nominally  $\pm 0.30$  dB

## General

Description	Specifications	Supplemental Information
<b>Trigger</b>		
Trigger source		RF burst (wideband), Video (IF envelope), Ext Front, Ext Rear. Actual available choices are dependent on measurement selection.
Trigger delay, level, and slope		Each trigger source has a separate set of these parameters.
Trigger delay		
Range	-100 to +500 ms	
Repeatability	±33 ns	
Resolution	33 ns	
External trigger inputs		
Level		-5 V to +5 V, characteristic
Impedance		10 kW (nominal)
<b>Range Control</b>		RF Input Autorange <sup>a</sup> Manually set <b>Max Total Pwr</b> Manually set <b>Input Atten</b>

- a. Auto range is not continuous with each measurement acquisition; it will run only once immediately following a measurement restart, initiated either by pressing the **Restart** key, or by sending the GPIB command `INIT:IMM`. This behavior was chosen to maintain best measurement speed, but it requires caution when input power levels change. If the input signal power changes, the analyzer will not readjust the input attenuators for optimal dynamic range unless a measurement restart is initiated. For example, if a sequence of power measurements is made, beginning with a maximum power level that is large enough to require non-zero input attenuation, it is advisable to do a measurement restart to automatically set a lower input attenuator value to maintain optimal dynamic range for approximately every 3 dB the input signal power level is reduced, or smaller, depending upon how precisely dynamic range needs to be optimized. Conversely, if the input signal power increases to a high enough level, input overloading will occur if the input attenuators are not readjusted by doing a measurement restart.



---

## **13** **NADC Measurement Personality**

This chapter contains specifications for the PSA series, Option BAE, NADC measurement personality.

## Additional Definitions and Requirements

Because digital communications signals are noise-like, all measurements will have variations. The specifications apply only with adequate averaging to remove those variations.

The specifications apply in the frequency ranges documented in In-Band Frequency Range.

The specifications for this chapter apply to the E4440A, E4443A and E4445A spectrum analyzers. For the E4446A, E4447A, and E4448A, the performance is nominal only and not subject to any warranted specifications.

The measurement performance is only slightly different in the E4446A, E4447A, and E4448A when compared to the performance of the E4440A, E4443A and E4445A analyzers. Because the hardware performance of the analyzers is very similar but not identical, you can estimate the nominal performance of the measurements from the specifications in this chapter.

## Option BAE, NADC Measurement Personality

Description	Specifications	Supplemental Information
<b>Adjacent Channel Power Ratio</b>		
Minimum Power at RF Input		-50 dBm (nominal)
ACPR Dynamic Range		
At 30 kHz offset <sup>a</sup>		74 dB (nominal)
At 60 kHz offset		77 dB (nominal)
At 90 kHz offset		
ACPR Relative Accuracy	±0.08 dB <sup>b</sup>	

- a. An ideal NADC signal, filtered by a perfect root-raised-cosine filter, shows about -35.4 dB ACPR at the 30 kHz offset. The added noise power due to intermodulation distortions and phase noise in the analyzer is well below this level. Therefore, measurement accuracy at 30 kHz offset is not significantly impacted by the dynamic range of the analyzer.
- b. The specified ACPR accuracy applies if the measured ACPR substantially exceeds the analyzer dynamic range at the specified offset. At the nominal test limits for the offsets (-26, -45 and -45 dBc for 30, 60 and 90 kHz offsets), for RF power above -25 dBm, this condition is met. When this condition is not met, there are additional errors due to the addition of analyzer spectral components to UUT spectral components. The spectral components from the analyzer will be non-coherent with the components from the UUT at the 60 and 90 kHz offsets. Because of this, the errors add in a power sense. The error is a function of the signal (UUT ACPR) to noise (analyzer ACPR dynamic range limitation) ratio, SN, in decibels.

The function is:

$$\text{error} = 10 \times \log(1 + 10^{-\text{SN}/10})$$

For example, if the UUT ACPR is -64 dB and the measurement floor is -74 dB, the SN ratio is 10 dB and the error due to adding the analyzer's noise to that of the UUT is 0.41 dB.

NADC Measurement Personality  
Option BAE, NADC Measurement Personality

Description	Specifications	Supplemental Information
<b>Error Vector Magnitude (EVM)</b> Minimum Power at RF Input EVM Operating range Floor Accuracy <sup>a</sup> Frequency Error Accuracy I/Q Origin offset DUT Maximum Offset Analyzer Noise Floor	0.5 %	-45 dBm (nominal)  0 to 18 % (nominal)  ±0.6 % (nominal)  ±2.0 Hz (nominal) + tfa <sup>b</sup>  -10 dBc (nominal) -50 dBc (nominal)
<b>Spectrum (Frequency Domain)</b>	See “Spectrum” on page 150.	
<b>Waveform (Time Domain)</b>	See “Waveform” on page 151.	

- a. The accuracy specification applies when the EVM to be measured is well above the measurement floor. When the EVM does not greatly exceed the floor, the errors due to the floor add to the accuracy errors. The errors due to the floor are noise-like and add incoherently with the UUT EVM. The errors depend on the EVM of the UUT and the floor as follows:  $\text{error} = \sqrt{\text{EVM}_{\text{UUT}}^2 + \text{EVM}_{\text{sa}}^2} - \text{EVM}_{\text{UUT}}$ , where  $\text{EVM}_{\text{UUT}}$  is the EVM of the UUT in percent, and  $\text{EVM}_{\text{sa}}$  is the EVM floor of the analyzer in percent. For example, if the EVM of the UUT is 7 %, and the floor is 2.5 %, the error due to the floor is 0.43 %. The total error can cause a reading as high as  $\text{EVM}_{\text{UUT}} + \text{floorerror} + \text{accyerror}$ , or as low as  $\text{EVM}_{\text{UUT}} - \text{accyerror}$ , where floorerror is the result of the error computation due to the floor, and accyerror is the specified accuracy.
- b. tfa = transmitter frequency × frequency reference accuracy

Description	Specifications	Supplemental Information
<b>In-Band Frequency Range</b>		
Cellular Band	824 to 849 MHz 869 to 894 MHz	
PCS Band	1850 to 1910 MHz 1930 to 1990 MHz	



## General

Description	Specifications	Supplemental Information
<b>Trigger</b>		
Trigger source		RF burst (wideband), Video (IF envelope), Ext Front, Ext Rear. Actual available choices dependent on measurement.
Trigger delay, level, and slope		Each trigger source has a separate set of these parameters.
Trigger delay		
Range	-100 to +500 ms	
Repeatability	±33 ns	
Resolution	33 ns	
External trigger inputs		
Level		-5 V to +5 V (nominal)
Impedance		10 kW (nominal)
<b>Range Control</b>		RF Input Autorange <sup>a</sup> Manually set <b>Max Total Pwr</b> Manually set <b>Input Atten</b>

- a. Auto range is not continuous with each measurement acquisition; it will run only once immediately following a measurement restart, initiated either by pressing the **Restart** key, or by sending the GPIB command `INIT:IMM`. This behavior was chosen to maintain best measurement speed, but it requires caution when input power levels change. If the input signal power changes, the analyzer will not readjust the input attenuators for optimal dynamic range unless a measurement restart is initiated. For example, if a sequence of power measurements is made, beginning with a maximum power level that is large enough to require non-zero input attenuation, it is advisable to do a measurement restart to automatically set a lower input attenuator value to maintain optimal dynamic range for approximately every 3 dB the input signal power level is reduced, or smaller, depending upon how precisely dynamic range needs to be optimized. Conversely, if the input signal power increases to a high enough level, input overloading will occur if the input attenuators are not readjusted by doing a measurement restart.



---

## **14 PDC Measurement Personality**

This chapter contains specifications for the PSA series, Option BAE, PDC measurement personality.

## **Additional Definitions and Requirements**

Because digital communications signals are noise-like, all measurements will have variations. The specifications apply only with adequate averaging to remove those variations.

The specifications apply in the frequency ranges documented in In-Band Frequency Range.

The specifications for this chapter apply to the E4440A, E4443A and E4445A spectrum analyzers. For the E4446A, E4447A, and E4448A, the performance is nominal only and not subject to any warranted specifications.

The measurement performance is only slightly different in the E4446A, E4447A, and E4448A when compared to the performance of the E4440A, E4443A and E4445A analyzers. Because the hardware performance of the analyzers is very similar but not identical, you can estimate the nominal performance of the measurements from the specifications in this chapter.

## Option BAE, PDC Measurement Personality

Description	Specifications	Supplemental Information
<b>Adjacent Channel Power Ratio</b>		
Minimum Power at RF Input		–36 dBm (nominal)
ACPR Dynamic Range		74 dB (nominal)
At 50 kHz offset		78 dB (nominal)
At 100 kHz offset		
ACPR Relative Accuracy	±0.08 dB <sup>a</sup>	
<b>Error Vector Magnitude (EVM)</b>		
Minimum Power at RF Input		–50 dBm (nominal)
EVM		
Operating range		0 to 18 % (nominal)
Floor	0.5 %	
Accuracy <sup>b</sup>		±0.6 % (nominal)
I/Q Origin offset		
DUT Maximum Offset		–12 dBc (nominal)
Analyzer Noise Floor		–50 dBc (nominal)
Frequency Error		
Accuracy		±2.0 Hz + tfa <sup>c</sup>
<b>Spectrum (Frequency Domain)</b>	See “Spectrum” on page 150.	
<b>Waveform (Time Domain)</b>	See “Waveform” on page 151.	

- a. The specified ACPR accuracy applies if the measured ACPR substantially exceeds the analyzer dynamic range at the specified offset. When this condition is not met, there are additional errors due to the addition of analyzer spectral components to UUT spectral components. The spectral components from the analyzer will be non-coherent with the components from the UUT. Because of this, the errors add in a power sense. The error is a function of the signal (UUT ACPR) to noise (analyzer ACPR dynamic range limitation) ratio, SN, in decibels.

The function is:  $\text{error} = 10 \times \log(1 + 10^{-SN/10})$

For example, if the UUT ACPR is –64 dB and the measurement floor is –74 dB, the SN ratio is 10 dB and the error due to adding the analyzer's noise to that of the UUT is 0.41 dB.

With the nominal dynamic ranges shown, and with ACP at the nominal test limits of –45 and –60 dB, and with an input RF power well above –18 dBm, the errors due to dynamic range limitations are nominally ±0.005 dB at 50 kHz offset and ±0.07 dB at 100 kHz offset.

PDC Measurement Personality  
Option BAE, PDC Measurement Personality

- b. The accuracy specification applies when the EVM to be measured is well above the measurement floor. When the EVM does not greatly exceed the floor, the errors due to the floor add to the accuracy errors. The errors due to the floor are noise-like and add incoherently with the UUT EVM. The errors depend on the EVM of the UUT and the floor as follows:  $\text{error} = \sqrt{\text{EVMUUT}^2 + \text{EVMsa}^2} - \text{EVMUUT}$ , where EVMUUT is the EVM of the UUT in percent, and EVMsa is the EVM floor of the analyzer in percent. For example, if the EVM of the UUT is 7 %, and the floor is 2.5 %, the error due to the floor is 0.43 %. The total error can cause a reading as high as  $\text{EVMUUT} + \text{floorerror} + \text{accyerror}$ , or as low as  $\text{EVMUUT} - \text{accyerror}$ , where floorerror is the result of the error computation due to the floor, and accyerror is the specified accuracy.
- c.  $\text{tfa} = \text{transmitter frequency} \times \text{frequency reference accuracy}$

Description	Specifications	Supplemental Information
<b>Occupied Bandwidth</b> Minimum power at RF Input Frequency Resolution Frequency Accuracy	100 Hz	-60 dBm (nominal)  -50 to -150 Hz (nominal) <sup>a</sup>

- a. The errors in the Occupied Bandwidth measurement are mostly due to the noisiness of any measurement of a noise-like signal, such as the PDC signal. The observed standard deviation of the OBW measurement is 270 Hz, so with 100 averages, the standard deviation should be well under the display resolution. The frequency errors due to the FFT processing are computed to be only 2.9 Hz with the narrow RBW (140 Hz) used. For large numbers of averages, the error is within the quantization error shown.

Description	Specifications	Supplemental Information
<b>In-Band Frequency Range</b>  800 MHz Band #1  800 MHz Band #2  800 MHz Band #3  1500 MHz Band	810 to 828 MHz 940 to 958 MHz  870 to 885 MHz 925 to 940 MHz  838 to 840 MHz 893 to 895 MHz  1477 to 1501 MHz 1429 to 1453 MHz	

## General

Description	Specifications	Supplemental Information
<b>Trigger</b>		
Trigger source		RF burst (wideband), Video (IF envelope), Ext Front, Ext Rear, Frame Timer. Actual available choices dependent on measurement.
Trigger delay, level, and slope		Each trigger source has a separate set of these parameters.
Trigger delay		
Range	-100 to +500 ms	
Repeatability	±33 ns	
Resolution	33 ns	
External trigger inputs		
Level		-5 V to +5 V (nominal)
Impedance		10 kW (nominal)
<b>Range Control</b>		RF Input Autorange <sup>a</sup> Manually set <b>Max Total Pwr</b> Manually set <b>Input Atten</b>

- a. Auto range is *not* continuous with each measurement acquisition; it will run only once immediately following a measurement restart, initiated either by pressing the **Restart** key, or by sending the GPIB command `INIT:IMM`. This behavior was chosen to maintain best measurement speed, but it requires caution when input power levels change. If the input signal power changes, the analyzer will not readjust the input attenuators for optimal dynamic range unless a measurement restart is initiated. For example, if a sequence of power measurements is made, beginning with a maximum power level that is large enough to require non-zero input attenuation, it is advisable to do a measurement restart to automatically set a lower input attenuator value to maintain optimal dynamic range for approximately every 3 dB the input signal power level is reduced, or smaller, depending upon how precisely dynamic range needs to be optimized. Conversely, if the input signal power increases to a high enough level, input overloading will occur if the input attenuators are not readjusted by doing a measurement restart.







## Option 211, TD SCDMA Measurement Personality

Description	Specification	Supplemental Information
<b>Power vs. Time</b>		Note: RRC filter not supported
Burst Type		Traffic, UpPTS and DwPTS
<b>Full radio frame mask<sup>a</sup></b>		±10 ms mask delay
<b>Transmit power</b>		Min, Max, Mean
<b>Dynamic range</b>		112 dB (nominal)
<b>Trigger</b>		External front, rear
Averaging type		Off, RMS, Log
Measurement time		Up to 9 slots

a. Mask supports consecutive timeslots (standards compliant). Masks are user definable over the bus.

Description	Specification	Supplemental Information
<b>Transmit Power</b>		Note: RRC filter not supported
Burst Types		Traffic, UpPTS, DwPTS
Measurement method		Above threshold, Burst width
Measurement results type		Min, Max, Mean
Trigger		External Front, External Rear, RF Burst, Free Run
Average type		Off, RMS, Log
Average mode		Exponential, Repeat
Measurement time		Up to 18 slots

Description	Specification	Supplemental Information
<b>Adjacent Channel Power</b>  Limits <sup>a</sup> Filter Measurement Type  Noise correction		Customizable up to 6 offsets  None, RRC (variable alpha)  Total Power Ref, PSD (power spectral density) Ref  On, Off

a. Default settings for the limits are standards compliant.

Description	Specification	Supplemental Information
<b>Multi-Carrier Power</b>  Carriers supported Averaging type Limits <sup>a</sup>  Noise correction		RRC filter supported  Up to 12 carriers  RMS  Customizable up to 3 offsets (relative and absolute)  On, Off

a. Default settings for the limits are standards compliant.

TD-SCDMA Measurement Personality  
**Option 211, TD SCDDMA Measurement Personality**

Description	Specification	Supplemental Information
<b>Spurious Emissions<sup>a</sup></b>		
User definable range table <sup>b</sup>		Define up to 20 ranges
Reported spurs		Up to 200 spurs can be reported
Average Type		RMS (Trace averaging also supported)
Average mode		Exponential, Repeat
Peak threshold range <sup>c</sup>		+7 dBm to -93 dBm
Peak excursion range <sup>c</sup>		0 to 100 dB
<b>Spectrum Emission Mask</b>		
Offsets from channel		5 offsets (compliant or user defined)
Fail mask		Absolute; Relative; Absolute AND relative; Absolute OR relative
<b>General Information</b>		Automatic input and reference level setting
Device Type		Mobile station, Base transceiver station
Standards Compliant		1.28 Mcps TSM 3.1.0/NTDD

- a. This applications takes into account the differences between mobile station and base station default values based on the standards set forth in CWTS TSM 05.05V3.1.
- b. User definable center frequency, span, resolutions bandwidth, video bandwidth, sweep time and absolute parameters for each range.
- c. Spurs that are both above the peak threshold and meet the peak excursion criteria will be measured.



## Additional Definitions and Requirements

Because digital communications signals are noise-like, all measurements will have variations. The specifications apply only with adequate averaging to remove those variations.

The specifications apply in the frequency ranges documented in In-Band Frequency Range.

The specifications for this chapter apply to the E4440A, E4443A and E4445A spectrum analyzers. For the E4446A, E4447A, and E4448A, the performance is nominal only and not subject to any warranted specifications.

The measurement performance is only slightly different in the E4446A, E4447A, and E4448A when compared to the performance of the E4440A, E4443A and E4445A analyzers. Because the hardware performance of the analyzers is very similar but not identical, the user can estimate the nominal performance of the measurements from the specifications in this chapter.



TD-SCDMA/HSDPA/8PSK Measurement Personalities  
Measurement Specifications

Description	Specifications	Supplemental Information
<p><b>Modulation Accuracy</b> <b>(Composite EVM)</b></p> <p>BTS Measurements  <math>-25 \text{ dBm} \leq \text{ML}^a \leq -15 \text{ dBm}</math>                      Preamp (<i>Option IDS</i>) Off, except as noted</p> <p>Composite EVM</p> <p>Minimum power at RF input                      Preamp (<i>Option IDS</i>) Off                      Preamp (<i>Option IDS</i>) On</p> <p>Maximum power at RF input                      Preamp (<i>Option IDS</i>) On</p> <p>Test signal with TS0 active with one DPCH per timeslot                      Accuracy<sup>e</sup></p> <p>Test signal with TS2 active with 4 HS-PDSCH per timeslot                      Accuracy<sup>f</sup></p> <p>Peak Code Domain Error                      Test signal with TS0 active with one DPCH per timeslot                      Accuracy</p> <p>Test signal with TS2 active with 4 HS-PDSCH per timeslot                      Accuracy</p> <p>I/Q Origin Offset                      DUT Maximum Offset                      Analyzer Noise Floor</p> <p>Frequency Error                      Range                      Accuracy</p>		<p>Following specifications are 95 %<sup>b</sup>, unless stated as (nominal).</p> <p>–60 dBm (nominal)<sup>c d</sup>                      –75 dBm (nominal)</p> <p>–45 dBm (nominal)</p> <p>±1.0 % (nominal)</p> <p>±1.0 % (nominal)</p> <p>±1.0 dB (nominal)</p> <p>±1.0 dB (nominal)</p> <p>–10 dBc (nominal)                      –50 dBc (nominal)</p>

- a. ML (mixer level) is RF input power – attenuation.
- b. All specifications given are derived from 95<sup>th</sup> percentile observations with 95 % confidence.
- c. Predefined test models under the Symbol Boundary menu are recommended for RF input power levels below –60 dBm. At low signal-to-noise ratios the auto channel ID algorithm may not correctly detect an active code channel as turned on. The predefined test model bypasses the auto channel ID algorithm.



- d. Nominal operating range. Accuracy specification applies when mixer level (RF input power minus attenuation) is between  $-25$  and  $-15$  dBm.
- e. The accuracy specification applies when the EVM to be measured is well above the measurement floor. When the EVM does not greatly exceed the floor, the errors due to the floor add to the accuracy errors. The errors due to the floor are noise-like and add incoherently with the UUT EVM. The errors depend on the EVM of the UUT and the floor as follows:  $\text{error} = \sqrt{\text{EVM}_{\text{UUT}}^2 + \text{EVM}_{\text{sa}}^2} - \text{EVM}_{\text{UUT}}$ , where  $\text{EVM}_{\text{UUT}}$  is the EVM of the UUT in percent, and  $\text{EVM}_{\text{sa}}$  is the EVM floor of the analyzer in percent. For example, if the EVM of the UUT is 7 %, and the floor is 2.5 %, the error due to the floor is 0.43 %. The total error can cause a reading as high as  $\text{EVM}_{\text{UUT}} + \text{floorerror} + \text{accyerror}$ , or as low as  $\text{EVM}_{\text{UUT}} - \text{accyerror}$ , where  $\text{floorerror}$  is the result of the error computation due to the floor, and  $\text{accyerror}$  is the specified accuracy.
- f. The accuracy specification applies when the EVM to be measured is well above the measurement floor. When the EVM does not greatly exceed the floor, the errors due to the floor add to the accuracy errors. The errors due to the floor are noise-like and add incoherently with the UUT EVM. The errors depend on the EVM of the UUT and the floor as follows:  $\text{error} = \sqrt{\text{EVM}_{\text{UUT}}^2 + \text{EVM}_{\text{sa}}^2} - \text{EVM}_{\text{UUT}}$ , where  $\text{EVM}_{\text{UUT}}$  is the EVM of the UUT in percent, and  $\text{EVM}_{\text{sa}}$  is the EVM floor of the analyzer in percent. For example, if the EVM of the UUT is 7 %, and the floor is 2.5 %, the error due to the floor is 0.43 %. The total error can cause a reading as high as  $\text{EVM}_{\text{UUT}} + \text{floorerror} + \text{accyerror}$ , or as low as  $\text{EVM}_{\text{UUT}} - \text{accyerror}$ , where  $\text{floorerror}$  is the result of the error computation due to the floor, and  $\text{accyerror}$  is the specified accuracy.

## Frequency

Description	Specifications	Supplemental Information
<b>In-Band Frequency Range</b>	a) 1900 to 1920 MHz 2010 to 2025 MHz  b) 1850 to 1910 MHz 1930 to 1990 MHz  c) 1910 to 1930 MHz	

## General

Description	Specifications	Supplemental Information
<b>Trigger</b>  Trigger source  Trigger delay, level, and slope  Trigger delay Range Repeatability Resolution  External trigger inputs Level Impedance  <b>Range Control</b>	          -100 to +500 ms ±33 ns 33 ns	          RF burst (wideband), Video (IF envelope), Ext Front, Ext Rear. Actual choices are dependent on measurement.  Each trigger source has separate set of these parameters.      -5 V to +5 V (nominal) 10 kW (nominal)  RF Input Autorange <sup>a</sup> Manually set <b>Max Total Pwr</b> Manually set <b>Input Atten</b>

- a. Autorange is not continuous with each measurement acquisition; it will run only once immediately following a measurement restart, initiated either by pressing the Restart key, or by sending the GPIB command INIT:IMM. This behavior was chosen to maintain best measurement speed, but it requires caution when input power levels change. If the input signal power changes, the analyzer will not readjust the input attenuators for optimal dynamic range unless a measurement restart is initiated. For example, if a sequence of power measurements is made, beginning with a maximum power level that is large enough to require non-zero input attenuation, it is advisable to do a measurement restart to automatically set a lower input attenuator value to maintain optimal dynamic range for approximately every 3 dB the input signal power level is reduced, or smaller, depending upon how precisely dynamic range needs to be optimized. Conversely, if the input signal power increases to a high enough level, input overloading will occur if the input attenuators are not readjusted by doing a measurement restart.



## Frequency

Description	Specifications	Supplemental Information
<b>Frequency Range</b>		
E4443A	10 MHz to 6.7 GHz	
E4445A	10 MHz to 13.2 GHz	
E4440A	10 MHz to 26.5 GHz	
E4446A	10 MHz to 44 GHz	
E4448A	10 MHz to 50 GHz	
<b>Frequency Span</b>		
Minimum Span	10 Hz	
Maximum Usable Span		
Center Frequency $\leq$ 3.0 GHz	40 MHz	
Center Frequency $>$ 3.0 GHz		
Preselector On		40 MHz (nominal)
Preselector Off <sup>a</sup>	40 MHz	
<b>Resolution Bandwidth</b> (Spectrum Measurement)		
Range		
Overall	500 mHz to 3 MHz	
Span = 40 MHz	3 kHz to 3 MHz	
Span = 1 MHz	50 Hz to 1 MHz	
Span = 10 kHz	1 Hz to 10 kHz	
Span = 100 Hz	500 mHz to 100 Hz	
Window Shapes	Flat Top, Uniform, Hanning, Hamming, Gaussian, Blackman, Blackman-Harris, Kaiser-Bessel (K-B 70 dB, K-B 90 dB & K-B 110 dB)	
<b>Analysis Bandwidth (Span)</b> (Waveform Measurement)		
Gaussian Shape	10 Hz to 40 MHz	

a. Option 123 is installed and enabled

## Amplitude and Phase

Description	Specifications	Supplemental Information
<b>Full Scale Level<sup>a</sup></b> Dither Off <sup>b</sup> , 0 dB input attenuation <sup>c</sup> , 0 dB IF gain <sup>c</sup>	-16 dBm	
IF Gain Control	-12 dB to +12 dB	2 dB steps
Overload Level <sup>d</sup>		
For E4440A/43A/45A		
Band 0		+4 dBfs (nominal)
		<b>Preselector On</b>   <b>Preselector Off<sup>e</sup></b>
Band 1		+5 dBfs (nominal)   +5 dBfs (nominal)
Band 2		+6 dBfs (nominal)   +8 dBfs (nominal)
Band 3		+5 dBfs (nominal)   +9 dBfs (nominal)
Band 4		+5 dBfs (nominal)   +19 dBfs (nominal)
For E4446A/48A		
Band 0		+2 dBfs (nominal)
		<b>Preselector Off<sup>e</sup></b>
Band 1		+5 dBfs (nominal)
Band 2		+5 dBfs (nominal)
Band 3		+5 dBfs (nominal)
Band 4		+10 dBfs (nominal)
Band 5		+8 dBfs (nominal)
Band 6		+12 dBfs (nominal)
Band 7		+20 dBfs (nominal)

- The full scale level is the reference for specifications with dBfs (decibels relative to full scale) units. It is a level that is sure to be free of overload.
- The full scale level decreases by nominally 2 dB when dither is on.
- The full scale level increases proportionally to input attenuation and decreases proportionally to IF gain. Full scale level = -16 dBm + RF attenuation - IF gain, where RF attenuation = 0, 2, 4, ..., 70 dB and IF gain = -12 to +12 dB.

40 MHz Bandwidth Digitizer - Option 140  
**Amplitude and Phase**

- d. For maximum dynamic range, signal levels may be controlled so that they approach the clipping level of the ADC in the wideband IF. That clipping level varies from nominally 2 dB above the Full Scale Level in the 10 MHz – 3.0 GHz band, to much higher levels in higher bands. The ratio of the clipping level to the Full Scale Level varies with band number and whether the preselector is off or on. At its highest, the ratio is about 20 dB at 26.5 GHz with the preselector off.
- e. Option 123 is installed and enabled.

Description	Specifications	Supplemental Information
<p><b>Absolute amplitude accuracy<sup>a b</sup></b> For E4440A/43A/45A</p> <p>At 50 MHz<sup>c</sup> 20 to 30 °C 0 to 55 °C</p> <p>For E4446A/48A</p> <p>At 50 MHz<sup>c</sup> 20 to 30 °C 0 to 55 °C</p> <p>Attenuator Switching<sup>d</sup></p> <p>Input Coupling<sup>e</sup></p> <p><b>RF Frequency Response</b> Relative to 50 MHz, measured at center of span, 10 dB input atten</p>	<p><math>\pm 0.30</math> dB <math>\pm 0.42</math> dB</p> <p><math>\pm 0.32</math> dB <math>\pm 0.42</math> dB</p> <p>See <a href="#">Chapter 1</a></p> <p>AC coupling only for E4440A/43A/45A.  DC coupling only for E4446A/48A</p> <p><b>Span</b> <math>\leq 36</math> MHz</p> <p><b>Span</b> &gt; 36 MHz</p> <p><math>\pm 0.52</math> dB    <math>\pm 0.51</math> dB</p> <p><math>\pm 0.71</math> dB    <math>\pm 0.64</math> dB</p>	<p>Mechanical attenuator only</p> <p>High pass filter corner frequency at -3 dB is 4 MHz (nominal)</p> <p>Typical<sup>f</sup> performance vs. Span</p> <p><b>Span</b> <math>\leq 36</math> MHz</p> <p><b>Span</b> &gt; 36 MHz</p> <p><math>\pm 0.22</math> dB    <math>\pm 0.11</math> dB</p> <p><math>\pm 0.40</math> dB</p> <p><math>\pm 1.20</math> dB</p> <p><math>\pm 0.70</math> dB</p> <p><math>\pm 2.00</math> dB</p> <p><math>\pm 0.15</math> dB    <math>\pm 0.70</math> dB</p> <p><math>\pm 0.25</math> dB    <math>\pm 0.90</math> dB</p> <p><math>\pm 0.50</math> dB    <math>\pm 0.90</math> dB</p>
<p>For E4440A/43A/45A</p> <p>50 MHz to 3 GHz, 20 to 30 °C</p> <p>50 MHz to 3 GHz, 0 to 55 °C</p> <p>Preselector is On<sup>g</sup></p> <p>3.05 to 6.6 GHz</p> <p>&gt; 6.6 to 13.2 GHz</p> <p>&gt; 13.2 to 19.2 GHz</p> <p>&gt; 19.2 to 26.5 GHz</p> <p>Preselector is Off<sup>g</sup></p> <p>3.0 to 6.6 GHz</p> <p>&gt; 6.6 to 13.2 GHz</p> <p>&gt; 13.2 to 19.2 GHz</p>		

40 MHz Bandwidth Digitizer - Option 140  
Amplitude and Phase

Description	Specifications	Supplemental Information	
> 19.2 to 26.5 GHz		±0.80 dB	±1.00 dB
For E4446A/48A			
50 MHz to 3 GHz, 20 to 30 °C	±0.75 dB      ±0.85 dB	±0.35 dB	±0.35 dB
50 MHz to 3 GHz, 0 to 55 °C	±0.90 dB      ±1.00 dB		
Preselector is Off <sup>g</sup>			
3.0 to 6.6 GHz		±0.85 dB	±2.30 dB
> 6.6 to 13.2 GHz		±1.15 dB	±2.50 dB
> 13.2 to 19.2 GHz		±1.00 dB	±3.35 dB
> 19.2 to 26.5 GHz		±1.70 dB	±2.35 dB
> 26.5 to 31.15 GHz		±0.95 dB (nominal)	±1.50 dB (nominal)
> 31.15 to 41 GHz		±1.00 dB (nominal)	±1.50 dB (nominal)
> 41 to 50 GHz		±2.30 dB (nominal)	±2.50 dB (nominal)

- a. Absolute Amplitude at CF = Absolute Amplitude at 50 MHz + Attenuation Switching + RF Frequency Response + IF Frequency Response.
- b. Changes in the impedance seen by the **321.4 MHz Aux Output** port on the rear panel can impact the amplitude accuracy of the PSA> IF the impedance on this port is changed, the user should perform an **Align Now All** to ensure the amplitude accuracy of the PSA.
- c. Center of span, 10 dB input attenuation, flat top window.
- d. The wideband IF path uses the electromechanical attenuator.
- e. The effects of input Coupling are included within IF and RF Frequency Response.
- f. This “typical” is the performance observed at the worst center frequency and worst offset frequency within the ranges shown in 80 % of the instruments observed with 95 % confidence. Agilent measures 100 % of PSA analyzers for this performance in the factory production process. These performance results are not warranted.
- g. When Preselector is On, Band 1 starts at 3.05 GHz. When Preselector is Off (Option 123 is installed and enabled), Band 1 starts at 3.0 GHz.



Description			Specifications	Supplemental Information	
<b>IF Frequency Response<sup>a</sup></b> Relative to center frequency					
<b>Freq (GHz)</b>	<b>Span</b>	<b>Preselector</b>		<b>Typical</b>	<b>RMS (nominal)<sup>b</sup></b>
For E4440A/43A/45A					
≤ 3.0	≤ 30 MHz	n/a	±0.47 dB	±0.13 dB	0.08 dB
>3.0 to 3.05	≤ 30 MHz	On <sup>c</sup>	±0.57 dB	±0.28 dB	0.13 dB
> 3.0 to 3.05	≤ 30 MHz	Off <sup>d</sup>	±0.40 dB	±0.16 dB	0.06 dB
≤ 3.0	≤ 40 MHz	n/a	±0.65 dB	±0.30 dB	0.14 dB
> 3.0 to 3.05	≤ 40 MHz	On <sup>c</sup>	±0.73 dB	±0.30 dB	0.21 dB
> 3.0 to 3.05	≤ 40 MHz	Off <sup>d</sup>	±0.43 dB	±0.17 dB	0.09 dB
> 3.05 to 6.6	≤ 30 MHz	On		±1.10 dB	0.41 dB
> 3.05 to 6.6	≤ 30 MHz	Off <sup>d</sup>	±0.40 dB	±0.16 dB	0.06 dB
> 6.6 to 26.5	≤ 30 MHz	On		±1.30 dB	0.57 dB
> 6.6 to <10	≤ 30 MHz	Off <sup>d</sup>	±0.58 dB	±0.28 dB	0.11 dB
10 to 26.5	≤ 30 MHz	Off <sup>d</sup>	±0.56 dB	±0.16 dB	0.06 dB
> 3.05 to 6.6	≤ 40 MHz	Off <sup>d</sup>	±0.43 dB	±0.17 dB	0.09 dB
> 6.6 to 26.5	≤ 40 MHz	Off <sup>d</sup>	±0.96 dB	±0.30 dB	0.13 dB
For E4446A/48A					
≤ 3.0	≤ 30 MHz	Off <sup>d</sup>	±0.95 dB	±0.45 dB	0.15 dB
≤ 3.0	≤ 40 MHz	Off <sup>d</sup>	±1.15 dB	±0.60 dB	0.15 dB
> 3.0 to 6.6	≤ 30 MHz	Off <sup>d</sup>	±0.40 dB	±0.15 dB	0.05 dB
> 6.6 to 13.2	≤ 30 MHz	Off <sup>d</sup>	±0.70 dB	±0.30 dB	0.05 dB
> 13.2 to 19.2	≤ 30 MHz	Off <sup>d</sup>	±0.45 dB	±0.20 dB	0.05 dB

40 MHz Bandwidth Digitizer - Option 140  
Amplitude and Phase

Description			Specifications	Supplemental Information	
> 19.2 to 26.5	≤ 30 MHz	Off <sup>d</sup>	±0.70 dB	±0.30 dB	0.10 dB
> 26.5 to 31.15	≤ 30 MHz	Off <sup>d</sup>	±0.65 dB	±0.25 dB	0.05 dB
> 31.15 to 41	≤ 30 MHz	Off <sup>d</sup>	±0.70 dB	±0.25 dB	0.05 dB
> 41 to 50	≤ 30 MHz	Off <sup>d</sup>	±1.20 dB	±0.40 dB	0.10 dB
> 3.0 to 6.6	≤ 40 MHz	Off <sup>d</sup>	±0.80 dB	±0.30 dB	0.10 dB
> 6.6 to 13.2	≤ 40 MHz	Off <sup>d</sup>	±1.35 dB	±0.65 dB	0.15 dB
> 13.2 to 19.2	≤ 40 MHz	Off <sup>d</sup>	±0.75 dB	±0.35 dB	0.10 dB
> 19.2 to 26.5	≤ 40 MHz	Off <sup>d</sup>	±1.25 dB	±0.50 dB	0.10 dB
> 26.5 to 31.15	≤ 40 MHz	Off <sup>d</sup>	±1.00 dB	±0.40 dB	0.10 dB
> 31.15 to 41	≤ 40 MHz	Off <sup>d</sup>	±1.15 dB	±0.40 dB	0.10 dB
> 41 to 50	≤ 40 MHz	Off <sup>d</sup>	±1.60 dB	±0.55 dB	0.10 dB

- a. The effects of RF Coupling at low frequencies and the effects of low-pass filter roll-off above 3.05 GHz are both included within the IF Frequency Response.
- b. The listed performance is the rms of the amplitude deviation from the center frequency amplitude, where the rms is computed over the range of offset frequencies and center frequencies shown.
- c. With Preselector On, the IF frequency response performance is degraded at this frequency range. For better performance it is recommended to turn off the Preselector (Option 123 installed and enabled).
- d. Option 123 is installed and enabled

Description			Specification	Supplemental Information	
<b>IF Phase Linearity</b>					
Relative to mean phase linearity					
Freq (GHz)	Span (MHz)	Preselector	Typical <sup>a</sup>	RMS (nominal) <sup>b</sup>	
For E4440A/43A/45A					
≤ 3.0	≤ 30	n/a	±1.2°	0.3°	
< 0.3	≤ 40	n/a	±3.2°	1.1°	
0.3 to 3.0	≤ 40	n/a	±2.5°	0.6°	
> 3.0 to 6.6	≤ 30	On	±7.0° (nominal)	2.0°	
> 6.6 to 20	≤ 30	On	±10.0° (nominal)	2.1°	
> 3.0 to 20	≤ 30	Off <sup>c</sup>	±0.8°	0.2°	
> 20 to 26.5	≤ 30	Off <sup>c</sup>	±0.8° (nominal)	0.2°	
> 3.0 to 20	≤ 40	Off <sup>c</sup>	±1.2°	0.3°	
> 20 to 26.5	≤ 40	Off <sup>c</sup>	±1.2° (nominal)	0.3°	
For E4446A/48A					
≤ 3.0	≤ 30	Off <sup>c</sup>	±2.8°	0.6°	
< 0.3	≤ 40	Off <sup>c</sup>	±6.3°	1.4°	
0.3 to 3.0	≤ 40	Off <sup>c</sup>	±5.7°	1.0°	
> 3.0 to 20	≤ 30	Off <sup>c</sup>	±2.5°	0.2°	
> 20 to 26.5	≤ 30	Off <sup>c</sup>	±2.0° (nominal)	0.2°	
> 26.5 to 31.15	≤ 30	Off <sup>c</sup>	±1.4° (nominal)	0.2°	
> 31.15 to 41	≤ 30	Off <sup>c</sup>	±2.1° (nominal)	0.2°	
> 41 to 44	≤ 30	Off <sup>c</sup>	±2.1° (nominal)	0.2°	

40 MHz Bandwidth Digitizer - Option 140  
**Amplitude and Phase**

Description			Specification	Supplemental Information	
> 3.0 to 20	≤ 40	Off <sup>c</sup>		±4.4°	0.4°
> 20 to 26.5	≤ 40	Off <sup>c</sup>		±3.2° (nominal)	0.6°
> 26.5 to 31.15	≤ 40	Off <sup>c</sup>		±3.7° (nominal)	0.4°
> 31.15 to 41	≤ 40	Off <sup>c</sup>		±3.1° (nominal)	0.3°
> 41 to 44	≤ 40	Off <sup>c</sup>		±2.8° (nominal)	0.4°

- a. This “typical” is the performance observed at the worst center frequency and worst offset frequency within the ranges shown in 80 % of the instruments observed with 95 % confidence. Agilent measures 100 % of PSA analyzers for this performance in the factory production process. These performance results are not warranted.
- b. The listed performance is the rms of the phase deviation relative to the mean phase deviation from a linear phase condition, where the rms is computed over the range of offset frequencies and center frequencies shown.
- c. Option 123 is installed and enabled.

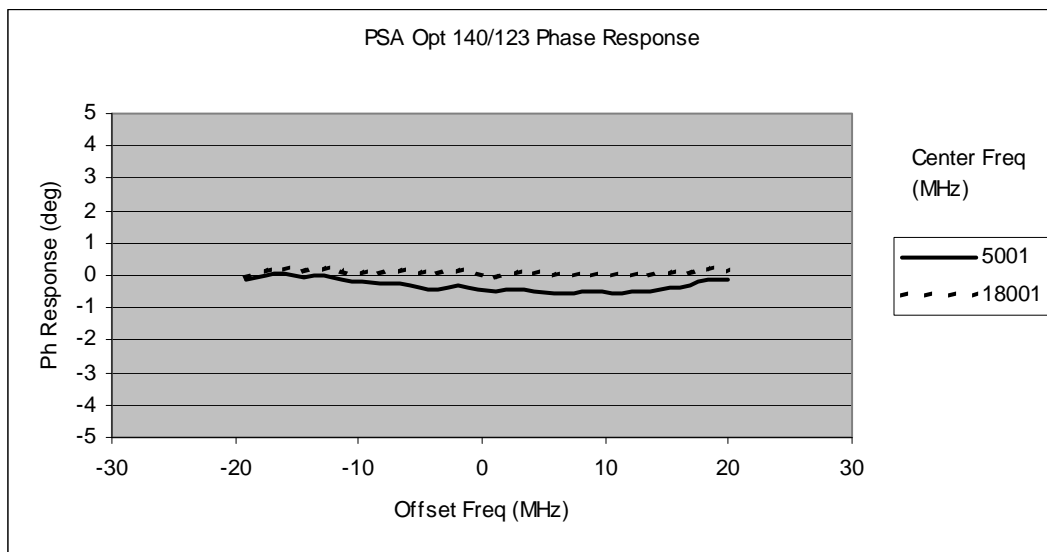
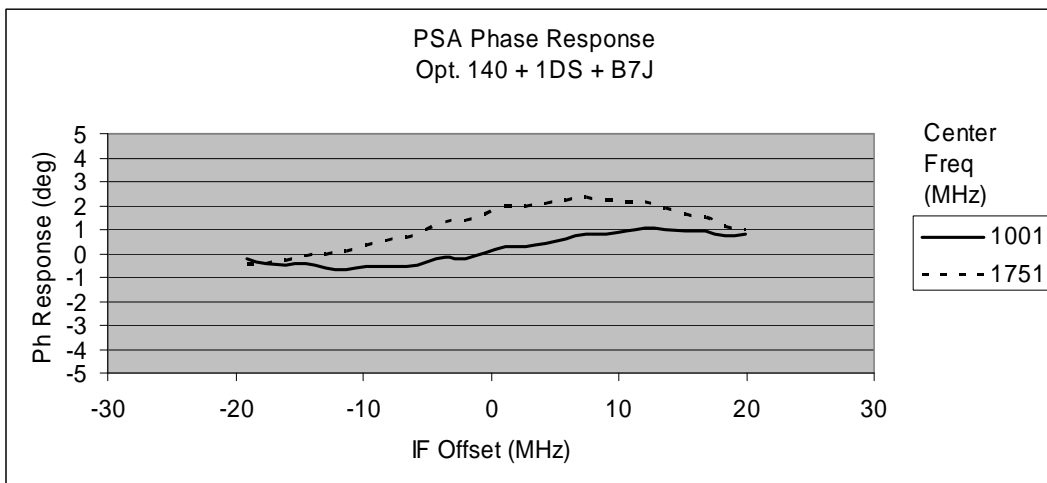
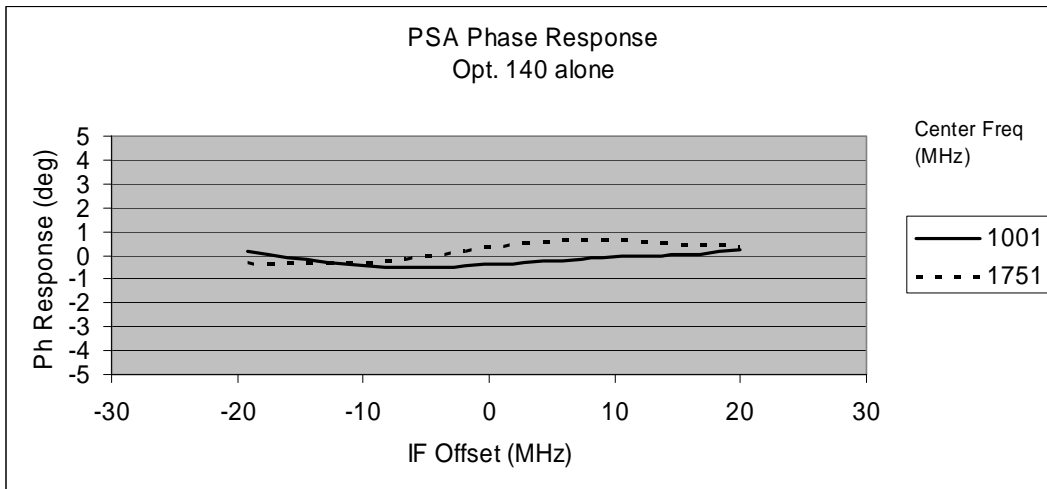

40 MHz Bandwidth Digitizer - Option 140  
**Amplitude and Phase**

Description	Specification	Supplemental Information
<b>EVM</b> EVM measurement floor for an 802.11g OFDM signal, using 89601A software equalization, channel estimation and data EQ  2.4 GHz  6.0 GHz		0.35 % (nominal)    0.56 % (nominal)

## Dynamic Range

Description				Specifications	Supplemental Information
<b>Third Order Intermodulation Distortion</b> Two tones of equal magnitude, 0 dB IF Gain					Verified with 1 MHz separation
<b>Freq</b>	<b>Span<sup>a</sup></b>	<b>Tone</b>	<b>Level<sup>b</sup></b>		
(GHz)	(MHz)	(dBfs)	(dBm)		
For E4440A/43A/45A					
≤ 3.05	≤ 30	-9	-25	-75 dBc	-80 dBc (typical)
≤ 3.05	≤ 40	-9	-25	-74 dBc	-78 dBc (typical)
≤ 3.05	≤ 30	-6	-22	-72 dBc	-77 dBc (typical; equivalent to +16.5 dBm TOI)
≤ 3.05	≤ 40	-6	-22	-70 dBc	-74 dBc (typical)
Preselector On					
> 3.05	≤ 30	-6	-22		-68 dBc (nominal)
Preselector Off <sup>b</sup>					
> 3.0	≤ 30	-6	-22		-70 dBc (nominal)
For E4446A/48A					
≤ 3.05	≤ 30	-9	-25	-75 dBc	-80 dBc (typical)
≤ 3.05	≤ 40	-9	-25	-74 dBc	-78 dBc (typical)
≤ 3.05	≤ 30	-6	-22	-72 dBc	-77 dBc (typical; equivalent to +16.5 dBm TOI)
≤ 3.05	≤ 40	-6	-22	-68 dBc	-74 dBc (typical)
Preselector On					
> 3.05 <sup>c</sup>	≤ 30	-4	-20		-65 dBc (nominal)
Preselector Off <sup>b</sup>					
> 3.0 <sup>c</sup>	≤ 30	-4	-20		-66 dBc (nominal)

40 MHz Bandwidth Digitizer - Option 140  
Dynamic Range

Description	Specifications	Supplemental Information
<p><b>Spurious (Input Related) Responses</b> Includes: aliased harmonic distortion, second-order IF inter modulation products, images about the center frequency. Preselector On.</p> <p><b>Freq</b>      <b>Span</b>      <b>Level</b> (GHz)      (MHz)      (dBfs)</p> <p>For E4440A/43A/45A</p> <p>≤ 3.05      ≤ 30      0</p> <p>≤ 3.05      ≤ 40      0</p> <p>&gt; 3.05      ≤ 30      0</p> <p>For E4446A/48A</p> <p>≤ 3.05      ≤ 30      0</p> <p>≤ 3.05      ≤ 40      0</p> <p>&gt; 3.05      ≤ 30      0</p>	<p>–73 dBc</p> <p>–65 dBc</p> <p>–64 dBc</p> <p>–54 dBc</p>	<p>Excludes second harmonic of RF input; see “<a href="#">Second Harmonic Distortion</a>” on page 74.</p> <p>–82 dBc (typical)</p> <p>–76 dBc (typical)</p> <p>–68 dBc (nominal)</p> <p>–74 dBc (typical)</p> <p>–65 dBc (typical)</p> <p>–62 dBc (nominal)</p>

- a. Specifications apply for the “best practices” case of using the central portion of the 36 and 40 MHz bandwidths. Noise and distortion performance degrade by about 4 dB at the edges of these bandwidths.
- b. Option 123 is installed and enabled.
- c. Up to 33 GHz. Above 33 GHz, the noise floor dominates the dynamic range specifications.



Description			Specifications	Supplemental Information
<b>Input Noise Density</b>				Excluding residuals; Preselector On, unless otherwise stated.
<b>Freq (GHz)</b>	<b>Span (MHz)</b>	<b>IF Gain (dB)</b>		
For E4440A/43A/45A				Non-option 123
≤ 3.05	≤ 30	-12	-136 dBfs/Hz	-140 dBfs/Hz <sup>a</sup> (nominal)
≤ 3.05	≤ 40	-12	-133 dBfs/Hz	
≤ 3.05	≤ 30	0	-130 dBfs/Hz	-134 dBfs/Hz (typical)
≤ 3.05	≤ 30	0	-130 dBfs/Hz	-137 dBfs/Hz @ 1 GHz (typical)
≤ 3.05	≤ 40	0	-130 dBfs/Hz	
3.0 to 6.6 <sup>b</sup>	≤ 30	0	-130 dBfs/Hz	-133 dBfs/Hz (typical)
For E4440A/43A/45A (Opt 110 preamp installed but Off)				Non-option 123
≤ 3.05	≤ 30	-12	-135 dBfs/Hz	-133 dBfs/Hz <sup>a</sup> (nominal)
≤ 3.05	≤ 40	-12	-132 dBfs/Hz	
≤ 3.05	≤ 30	0	-129 dBfs/Hz	-134 dBfs/Hz (typical)
≤ 3.05	≤ 30	0	-129 dBfs/Hz	-136 dBfs/Hz @ 1 GHz (typical)
≤ 3.05	≤ 40	0	-129 dBfs/Hz	
3.0 to 6.6 <sup>b</sup>	≤ 30	0	-128 dBfs/Hz	-131 dBfs/Hz (typical)
				The following are nominal:
				Preselector On
				Preselector Off <sup>b</sup>
				<b>≤30 MHz Span</b>
				<b>≤40 MHz Span</b>
3.05 to 6.6			-135 dBfs/Hz	-135 dBfs/Hz
> 6.6 to 13.2			-132 dBfs/Hz	-128 dBfs/Hz
> 13.2 to 19.2			-132 dBfs/Hz	-123 dBfs/Hz
> 19.2 to 26.5			-128 dBfs/Hz	-116 dBfs/Hz
For E4446A/48A				
≤ 3.05	≤ 30	-12	-133 dBfs/Hz	-138 dBfs/Hz (nominal)
≤ 3.05	≤ 40	-12	-130 dBfs/Hz	-138 dBfs/Hz (nominal)
≤ 3.05	≤ 30	0	-127 dBfs/Hz	-132 dBfs/Hz (typical)

40 MHz Bandwidth Digitizer - Option 140  
**Dynamic Range**

Description			Specifications	Supplemental Information
≤ 3.05	≤ 40	0	-127 dBfs/Hz	-137 dBfs/Hz (nominal)
3.0 to 6.6 <sup>b</sup>	≤ 30	0	-125 dBfs/Hz	-128 dBfs/Hz (typical)
				The following are nominal:
				Preselector Off <sup>b</sup>
<b>Freq (GHz)</b>				<b>≤40 MHz Span</b>
3.0 to 6.6				-127 dBfs/Hz
> 6.6 to 13.2				-127 dBfs/Hz
> 13.2 to 19.2				-123 dBfs/Hz
> 19.2 to 26.5				-116 dBfs/Hz
> 26.5 to 31.15				-116 dBfs/Hz
> 31.15 to 41				-109 dBfs/Hz
> 41 to 50				-101 dBfs/Hz

- a. Specifications apply for the “best practices” case of using the central portion of the 36 and 40 MHz bandwidths. Noise and distortion performance degrade by about 4 dB at the edges of these bandwidths.
- b. Preselector is Off (Option 123 installed and enabled).

Description	Specifications	Supplemental Information
<p><b>Input Sensitivity (Noise Level)</b></p> <p>Input terminated, log averaging, 0 dB input attenuation, freq <math>\leq</math> 3.05 GHz, maximum IF gain</p> <p>For E4440A/43A/45A (Opt 1DS preamp installed but Off)</p> <p>For E4440A/43A/45A (Opt 110 preamp installed but Off)</p> <p>For E4446A/48A (Opt 1DS or 110 preamp installed but Off)</p>	<p>–152 dBm<sup>a b</sup></p> <p>–151 dBm<sup>a b</sup></p> <p>–149 dBm<sup>a b</sup></p>	<p>Excluding residuals; Non-option 123</p>

- a. This sensitivity is specified in a 1 Hz RBW, averaged on a log scale, much as is the Displayed Average Noise Level in chapter 1. The sensitivity in terms of noise density is 2.25 dB worse.
- b. Specifications apply for the “best practices” case of using the central portion of the 36 and 40 MHz bandwidths. Noise and distortion performance degrade by about 4 dB at the edges of these bandwidths.

Description	Specification	Supplemental Information
<p><b>Residual Responses</b></p> <p>Input terminated, 0 dB RF attenuation</p> <p>For E4440A/43A/45A</p> <p>Relative to Full-Scale<sup>a</sup></p> <p>Center Freq. (CF)      Span</p> <p><math>\leq</math> 3.0 GHz      <math>\leq</math> 40 MHz</p> <p><math>&gt;</math> 3.05 GHz and <math>\leq</math> 30 MHz <math>&lt;</math> 6.6 GHz</p> <p><math>&gt;</math> 3.0 GHz and <math>\leq</math> 40 MHz <math>&lt;</math> 6.6 GHz</p> <p>For E4446A/48A</p> <p>Relative to Full-Scale Level<sup>a</sup></p> <p>Center Freq. (CF)      Span</p> <p><math>\leq</math> 3.0 GHz      <math>\leq</math> 40 MHz</p> <p><math>&gt;</math> 3.05 GHz and <math>\leq</math> 30 MHz <math>&lt;</math> 6.6 GHz</p>	<p>–90 dBfs</p> <p>–85 dBfs</p> <p>–85 dBfs</p>	<p>Verified with IF Gain = –6 dB</p> <p>Preselector On</p> <p>–75 dBfs (nominal, Preselector Off<sup>b</sup>)</p> <p>Preselector On</p>

40 MHz Bandwidth Digitizer - Option 140  
Dynamic Range

Description	Specification	Supplemental Information
> 3.0 GHz and ≤ 30 MHz < 6.6 GHz		-80 dBfs (nominal, Preselector Off <sup>b</sup> )
> 3.0 GHz and ≤ 40 MHz < 6.6 GHz		-72 dBfs (nominal, Preselector Off <sup>b</sup> )
<b>Frequency Stability</b> Noise Sidebands  Center Frequency = 1 GHz, IF Gain = -12 dB  For E4440A/43A/45A		
<b>Offset Frequency</b>		
100 Hz		-91 dBc/Hz (nominal)
1 kHz		-100 dBc/Hz (nominal)
10 kHz	-106 dBc/Hz	
100 kHz	-119 dBc/Hz	
1 MHz <sup>c</sup>	-137 dBc/Hz	
For E4446A/48A		
<b>Offset Frequency</b>		
100 Hz		-91 dBc/Hz (nominal)
1 kHz		-100 dBc/Hz (nominal)
10 kHz	-103 dBc/Hz	
100 kHz	-116 dBc/Hz	
1 MHz <sup>c</sup>	-135 dBc/Hz	

- a. The Full-Scale level increases proportionally to input attenuation and decreases proportionally to IF gain. Full-Scale level (dBm) = -16 dBm + RF attenuation - IF gain, where RF attenuation = 0, 2, 4, ..., 70 dB and IF gain = -12 dB to +12 dB.
- b. Option 123 is installed and enabled.
- c. The noise specified at this offset includes both contributors: the phase noise of the LO and the relative level of broadband input noise, with minimum IF gain and a signal at full scale, approximately -4 dBm at the input mixer.

## Data Acquisition

Description	Specifications	Supplemental Information
<b>Time Record Length</b>		
Spectrum Measurement	32 to 180,000 samples	
Waveform Measurement		32 to $10^6$ samples (nominal)
<b>Deep Time Capture</b>		
Analysis BW > 20 MHz	$1.2 \times 10^8$ samples	
Analysis BW $\leq$ 20 MHz	$6 \times 10^7$ samples	
<b>ADC Resolution</b>	14 bits	

## Wideband IF Triggering

Description	Specification	Supplemental Information
<b>Trigger Types</b>	Free Run (immediate), Video (IF envelope), External Front, External Rear, Frame (periodic)	
<b>Frame (periodic) Trigger</b>		
Period		
Range	0 to > 500 ms	
Resolution	1 ns	
Offset Delay		
Range	0 to 10 s	
Resolution	10 ns	
Repeatability (when synchronized to an external source)		±10 ps jitter (nominal $\sigma$ )
<b>External Trigger</b>		
Trigger Delay		
Range	-100 ms to +500 ms	
Resolution	10 ns	
Repeatability		
Spectrum Mode (any span)		±1.5 ns (nominal $\sigma$ )
Waveform		
Analysis BW ≥ 6.25 MHz		±1.5 ns (nominal $\sigma$ )
Analysis BW < 6.25 MHz		±25 ns (nominal $\sigma$ )
Slope control, Input Impedance, Level Accuracy	See <a href="#">Chapter 1</a>	
<b>Video (IF Envelope) Trigger</b>		
Trigger Delay		
Range	0 to 500 ms	
Resolution	1 $\mu$ s	
Amplitude Range	0 to -80 dBfs	Usable range limited by noise

Description	Specification	Supplemental Information
<b>Trigger Hold off</b>		
Range	0 to 500 ms	
Resolution	10 ns	
<b>Auto Trigger</b>		
Time Interval Range	1 ms to 10 s	
<b>Time Averaging</b>		
Maximum block size for frame-triggered averaging	16384 samples	Analysis BW $\leq$ 20 MHz
Maximum number of averages	> 500,000	







## Frequency

Description	Specifications	Supplemental Information
<b>Frequency Range</b>		
E4443A	10 MHz to 6.7 GHz	
E4445A	10 MHz to 13.2 GHz	
E4440A	10 MHz to 26.5 GHz	
E4446A	10 MHz to 44 GHz	
E4448A	10 MHz to 50 GHz	
<b>Frequency Span</b>		
Minimum Span	10 Hz	
Maximum Usable Span		
Center Frequency $\leq$ 3.0 GHz	80 MHz	
Center Frequency $>$ 3.0 GHz		
Preselector On		40 to 80 MHz (nominal); see <a href="#">“Nominal IF Bandwidth”</a> on page 291.
Preselector Off <sup>a</sup>	80 MHz	
<b>Resolution Bandwidth</b> (Spectrum Measurement)		
Range		
Overall	500 mHz to 3 MHz	
Span = 80 MHz	3 kHz to 3 MHz	
Span = 1 MHz	50 Hz to 1 MHz	
Span = 10 kHz	1 Hz to 10 kHz	
Span = 100 Hz	500 mHz to 100 Hz	
Window Shapes	Flat Top, Uniform, Hanning, Hamming, Gaussian, Blackman, Blackman-Harris, Kaiser-Bessel (K-B 70 dB, K-B 90 dB & K-B 110 dB)	
<b>Analysis Bandwidth</b> (Span) (Waveform Measurement)		
Gaussian Shape	10 Hz to 80 MHz	

a. Option 123 is installed and enabled.

## Nominal IF Bandwidth

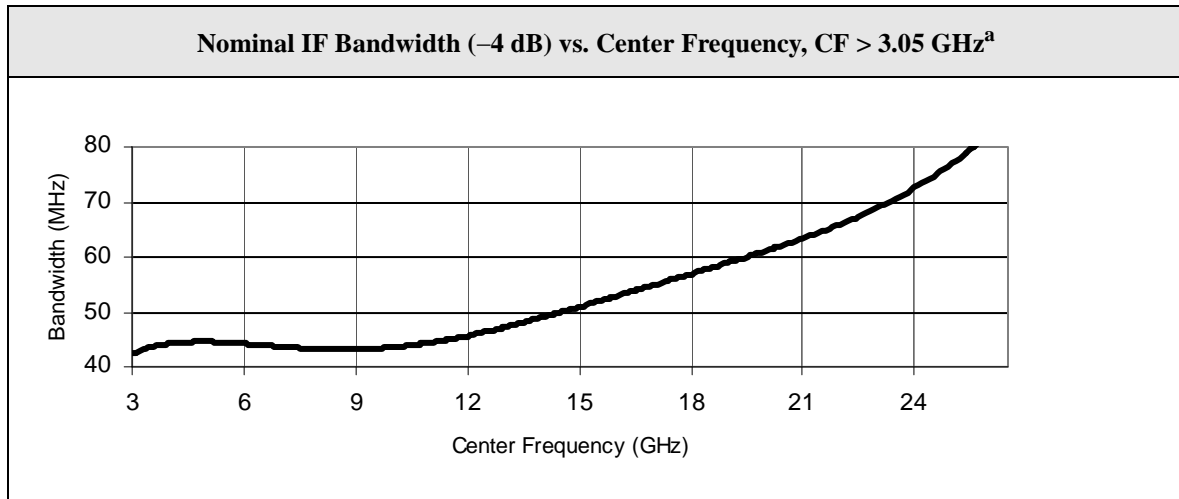

a. Preselector is On.

## Amplitude and Phase

Description	Specifications	Supplemental Information
<b>Full Scale Level<sup>a</sup></b> Dither Off <sup>b</sup> , 0 dB input attenuation <sup>c</sup> , 0 dB IF gain <sup>c</sup>	-16 dBm	
IF Gain Control	-12 dB to +12 dB	2 dB steps
Overload Level <sup>d</sup>		
For E4440A/43A/45A		
Band 0		+4 dBfs (nominal)
		Preselector On
		Preselector Off <sup>e</sup>
Band 1		+5 dBfs (nominal)
Band 2		+6 dBfs (nominal)
Band 3		+5 dBfs (nominal)
Band 4		+5 dBfs (nominal)
		+19 dBfs (nominal)
For E4446A/48A		
Band 0		+2 dBfs (nominal)
		<b>Preselector Off<sup>e</sup></b>
Band 1		+5 dBfs (nominal)
Band 2		+5 dBfs (nominal)
Band 3		+5 dBfs (nominal)
Band 4		+10 dBfs (nominal)
Band 5		+8 dBfs (nominal)
Band 6		+12 dBfs (nominal)
Band 7		+20 dBfs (nominal)

- The full scale level is the reference for specifications with dBfs (decibels relative to full scale) units. It is a level that is sure to be free of overload
- The full scale level decreases by nominally 2 dB when dither is on.
- The full scale level increases proportionally to input attenuation and decreases proportionally to IF gain. Full scale level (dBm) = -16 dBm + RF attenuation - IF gain where RF attenuation = 0, 2, 4, ..., 70 dB and IF gain = -12 to +12 dB.

- d. For maximum dynamic range, signal levels may be controlled so that they approach the clipping level of the ADC in the wideband IF. That clipping level varies from nominally 2 dB above the Full Scale Level in the 10 MHz – 3 GHz band, to much higher levels in higher bands. The ratio of the clipping level to the Full Scale Level varies with band number and whether the preselector is off or on. At its highest, the ratio is about 20 dB at 26.5 GHz with the preselector off.
- e. Option 123 is installed and enabled.

80 MHz Bandwidth Digitizer - Option 122  
Amplitude and Phase

Description	Specifications		Supplemental Information	
<b>Absolute amplitude accuracy<sup>a b</sup></b>				
For E4440A/43A/45A				
At 50 MHz <sup>c</sup> 20 to 30 °C 0 to 55 °C	±0.30 dB ±0.42 dB			
For E4446A/48A				
At 50 MHz <sup>c</sup> 20 to 30 °C 0 to 55 °C	±0.32 dB ±0.42 dB			
Attenuator Switching <sup>d</sup>	See <a href="#">Chapter 1</a>		Mechanical attenuator only	
Input Coupling <sup>e</sup>	AC coupling only for E4440A/43A/45A  DC coupling only for E4446A/48A		High pass filter corner frequency at –3 dB is 4 MHz (nominal)	
<b>RF Frequency Response</b>			<b>Typical<sup>f</sup> performance vs. Span</b>	
Relative to 50 MHz, measured at center of span, 10 dB input atten				
	<b>Span ≤ 36 MHz</b>	<b>Span &gt; 36 MHz</b>	<b>Span ≤ 36 MHz</b>	<b>Span &gt; 36 MHz</b>
For E4440A/43A/45A				
50 MHz to 3 GHz, 20 to 30 °C	±0.52 dB	±0.51 dB	±0.22 dB	±0.11 dB
50 MHz to 3 GHz, 0 to 55 °C	±0.71 dB	±0.64 dB		
Preselector On <sup>g</sup>				
3.05 to 6.6 GHz			±0.40 dB	
> 6.6 to 13.2 GHz			±1.20 dB	
> 13.2 to 19.2 GHz			±0.70 dB	
> 19.2 to 26.5 GHz			±2.00 dB	
Preselector is Off <sup>g</sup>				
3.0 to 6.6 GHz			±0.15 dB	±0.70 dB
> 6.6 to 13.2 GHz			±0.25 dB	±0.90 dB
> 13.2 to 19.2 GHz			±0.50 dB	±0.90 dB

Description	Specifications	Supplemental Information	
> 19.2 to 26.5 GHz For E4446A/48A		±0.80 dB	±1.00 dB
50 MHz to 3 GHz, 20 to 30 °C	±0.75 dB    ±0.85 dB	±0.35 dB	±0.35 dB
50 MHz to 3 GHz, 0 to 55 °C	±0.90 dB    ±1.00 dB		
Preselector is Off <sup>g</sup>			
3.0 to 6.6 GHz		±0.85 dB	±2.30 dB
> 6.6 to 13.2 GHz		±1.15 dB	±2.50 dB
> 13.2 to 19.2 GHz		±1.00 dB	±3.35 dB
> 19.2 to 26.5 GHz		±1.70 dB	±2.35 dB
> 26.5 to 31.15 GHz		±0.95 dB (nominal)	±1.50 dB (nominal)
> 31.15 to 41 GHz		±1.00 dB (nominal)	±1.50 dB (nominal)
> 41 to 50 GHz		±2.30 dB (nominal)	

- a. Absolute Amplitude at CF = Absolute Amplitude at 50 MHz + Attenuation Switching + RF Frequency Response + IF Frequency Response.
- b. Changes in the impedance seen by the **321.4 MHz Aux Output** port on the rear panel can impact the amplitude accuracy of the PSA if the impedance on this port is changed, the user should perform an **Align Now All** to ensure the amplitude accuracy of the PSA.
- c. Center of span, 10 dB input attenuation, flat top window.
- d. The wideband IF path uses the electromechanical attenuator.
- e. The effects of input Coupling are included within IF and RF Frequency Response.
- f. This “typical” is the performance observed at the worst center frequency and worst offset frequency within the ranges shown in 80% of the instruments observed with 95% confidence. Agilent measures 100% of PSA analyzers for this performance in the factory production process. These performance results are not warranted.
- g. When Preselector is On, Band 1 starts at 3.05 GHz. When Preselector is Off (Option 123 is installed and enabled), Band 1 starts at 3.0 GHz.

80 MHz Bandwidth Digitizer - Option 122  
Amplitude and Phase

Description			Specifications	Supplemental Information	
<b>IF Frequency Response<sup>a</sup></b>					
Relative to center frequency					
Freq (GHz)	Span	Preselector		Typical	RMS (nominal) <sup>b</sup>
For E4440A/43A/45A					
≤ 3.0	≤ 30 MHz	n/a	±0.47 dB	±0.13 dB	0.08 dB
> 3.0 to 3.05	≤ 30 MHz	On <sup>c</sup>	±0.57 dB	±0.28 dB	0.13 dB
> 3.0 to 3.05	≤ 30 MHz	Off <sup>c</sup>	±0.40 dB	±0.16 dB	0.06 dB
≤ 3.0	≤ 60 MHz	n/a	±0.65 dB	±0.30 dB	0.14 dB
> 3.0 to 3.05	≤ 60 MHz	On <sup>c</sup>	±0.73 dB	±0.30 dB	0.21 dB
> 3.0 to 3.05	≤ 60 MHz	Off <sup>d</sup>	±0.43 dB	±0.17 dB	0.09 dB
< 0.10	≤ 80 MHz	n/a	±1.09 dB	±0.50 dB	0.24 dB
0.10 to 3.00	≤ 80 MHz	n/a	±0.73 dB	±0.30 dB	0.18 dB
> 3.0 to 3.05	≤ 80 MHz	On <sup>c</sup>	±0.93 dB	±0.40 dB	0.25 dB
> 3.0 to 3.05	≤ 80 MHz	Off <sup>d</sup>	±0.63 dB	±0.19 dB	0.11 dB
> 3.05 to 6.6	≤ 30 MHz	On <sup>c</sup>		±1.10 dB	0.41 dB
> 3.05 to 6.6	≤ 30 MHz	Off <sup>d</sup>	±0.40 dB	±0.16 dB	0.06 dB
> 6.6 to 26.5	≤ 30 MHz	On <sup>c</sup>		±1.30 dB	0.57 dB
> 6.6 to < 10	≤ 30 MHz	Off <sup>d</sup>	±0.58 dB	±0.28 dB	0.11 dB
10 to 26.5	≤ 30 MHz	Off <sup>d</sup>	±0.56 dB	±0.16 dB	0.06 dB
> 3.05 to 6.6	≤ 60 MHz	Off <sup>d</sup>	±0.43 dB	±0.17 dB	0.09 dB
> 6.6 to 26.5	≤ 60 MHz	Off <sup>d</sup>	±0.96 dB	±0.30 dB	0.13 dB
> 3.05 to 6.6	≤ 80 MHz	Off <sup>d</sup>	±0.63 dB	±0.19 dB	0.11 dB
> 6.6 to 26.5	≤ 80 MHz	Off <sup>d</sup>	±1.13 dB	±0.40 dB	0.15 dB
For E4446A/48A					
≤ 3.0	≤ 30 MHz	Off <sup>d</sup>	±0.95 dB	±0.45 dB	0.15 dB
≤ 3.0	≤ 60 MHz	Off <sup>d</sup>	±1.15 dB	±0.60 dB	0.15 dB



Description			Specifications	Supplemental Information	
< 0.10	≤ 80 MHz	Off <sup>d</sup>	±1.05 dB	±0.70 dB	0.15 dB
0.10 to 3.0	≤ 80 MHz	Off <sup>d</sup>	±1.60 dB	±0.85 dB	0.20 dB
> 3.0 to 6.6	≤ 30 MHz	Off <sup>d</sup>	±0.40 dB	±0.15 dB	0.05 dB
> 6.6 to 13.2	≤ 30 MHz	Off <sup>d</sup>	±0.70 dB	±0.30 dB	0.05 dB
> 13.2 to 19.2	≤ 30 MHz	Off <sup>d</sup>	±0.45 dB	±0.20 dB	0.05 dB
> 19.2 to 26.5	≤ 30 MHz	Off <sup>d</sup>	±0.70 dB	±0.30 dB	0.10 dB
> 26.5 to 31.15	≤ 30 MHz	Off <sup>d</sup>	±0.65 dB	±0.25 dB	0.05 dB
> 31.15 to 41	≤ 30 MHz	Off <sup>d</sup>	±0.70 dB	±0.25 dB	0.05 dB
> 41 to 50	≤ 30 MHz	Off <sup>d</sup>	±1.20 dB	±0.40 dB	0.10 dB
> 3.0 to 6.6	≤ 60 MHz	Off <sup>d</sup>	±0.80 dB	±0.30 dB	0.10 dB
> 6.6 to 13.2	≤ 60 MHz	Off <sup>d</sup>	±1.35 dB	±0.65 dB	0.15 dB
> 13.2 to 19.2	≤ 60 MHz	Off <sup>d</sup>	±0.75 dB	±0.35 dB	0.10 dB
> 19.2 to 26.5	≤ 60 MHz	Off <sup>d</sup>	±1.25 dB	±0.50 dB	0.10 dB
> 26.5 to 31.15	≤ 60 MHz	Off <sup>d</sup>	±1.00 dB	±0.40 dB	0.10 dB
> 31.15 to 41	≤ 60 MHz	Off <sup>d</sup>	±1.15 dB	±0.40 dB	0.10 dB
> 41 to 50	≤ 60 MHz	Off <sup>d</sup>	±1.60 dB	±0.55 dB	0.10 dB
> 3.0 to 6.6	≤ 80 MHz	Off <sup>d</sup>	±1.00 dB	±0.50 dB	0.15 dB
> 6.6 to 13.2	≤ 80 MHz	Off <sup>d</sup>	±1.85 dB	±0.85 dB	0.20 dB
> 13.2 to 19.2	≤ 80 MHz	Off <sup>d</sup>	±0.80 dB	±0.35 dB	0.10 dB
> 19.2 to 26.5	≤ 80 MHz	Off <sup>d</sup>	±1.65 dB	±0.70 dB	0.15 dB
> 26.5 to 31.15	≤ 80 MHz	Off <sup>d</sup>	±1.20 dB	±0.50 dB	0.10 dB
> 31.15 to 41	≤ 80 MHz	Off <sup>d</sup>	±1.35 dB	±0.50 dB	0.10 dB
> 41 to 50	≤ 80 MHz	Off <sup>d</sup>	±2.30 dB	±0.75 dB	0.15 dB

- The effects of RF Coupling at low frequencies and the effects of low-pass filter roll-off above 3.05 GHz are both included within the IF Frequency Response.
- The listed performance is the rms of the amplitude deviation from the center frequency amplitude, where the rms is computed over the range of offset frequencies and center frequencies shown.
- With Preselector On, the IF frequency response performance is degraded at this frequency range. For better performance it is recommended to turn off the Preselector (Option 123 installed and enabled).
- Option 123 is installed and enabled.

80 MHz Bandwidth Digitizer - Option 122  
Amplitude and Phase

Description			Specification	Supplemental Information	
<b>IF Phase Linearity</b>					
Relative to mean phase linearity					
For E4440A/43A/45A					
<b>Freq (GHz)</b>	<b>Span (MHz)</b>	<b>Preselector</b>		<b>Typical<sup>a</sup></b>	<b>RMS (nominal)<sup>b</sup></b>
≤ 3.0	≤ 30	n/a		±1.2°	0.3°
< 0.3	≤ 60	n/a		±3.2°	1.1°
0.3 to 3.0	≤ 60	n/a		±2.5°	0.6°
< 0.3	≤ 80	n/a		±10.0°	2.3°
0.3 to 3.0	≤ 80	n/a		±4.0°	0.9°
> 3.0 to 6.6	≤ 30	On		±7.0° (nominal)	2.0°
> 6.6 to 20	≤ 30	On		±10.0° (nominal)	2.1°
> 3.0 to 20	≤ 30	Off <sup>c</sup>		±0.8°	0.2°
> 20 to 26.5	≤ 30	Off <sup>c</sup>		±0.8° (nominal)	0.2°
> 3.0 to 20	≤ 60	Off <sup>c</sup>		±1.2°	0.3°
> 20 to 26.5	≤ 60	Off <sup>c</sup>		±1.2° (nominal)	0.3°
> 3.0 to 20	≤ 80	Off <sup>c</sup>		±2.5°	0.4°
> 20 to 26.5	≤ 80	Off <sup>c</sup>		±2.5° (nominal)	0.4°
For E4446A/48A					
≤ 3.0	≤ 30	Off <sup>c</sup>		±2.8°	0.6°
< 0.3	≤ 60	Off <sup>c</sup>		±6.3°	1.4°
0.3 to 3.0	≤ 60	Off <sup>c</sup>		±5.7°	1.0°
< 0.3	≤ 80	Off <sup>c</sup>		±12.0°	2.4°
0.3 to 3.0	≤ 80	Off <sup>c</sup>		±10.7°	1.7°
> 3.0 to 20	≤ 30	Off <sup>c</sup>		2.5°	0.2°
> 20 to 26.5	≤ 30	Off <sup>c</sup>		2.0° (nominal)	0.2°
> 26.5 to 31.15	≤ 30	Off <sup>c</sup>		±1.4° (nominal)	0.2°

Description			Specification	Supplemental Information	
> 31.15 to 41	≤ 30	Off <sup>c</sup>		±2.1° (nominal)	0.2°
> 41 to 44	≤ 30	Off <sup>c</sup>		±2.1° (nominal)	0.2°
> 3.0 to 20	≤ 60	Off <sup>c</sup>		±4.4°	0.4°
> 20 to 26.5	≤ 60	Off <sup>c</sup>		±3.2° (nominal)	0.6°
> 26.5 to 31.15	≤ 60	Off <sup>c</sup>		±3.7° (nominal)	0.4°
> 31.15 to 41	≤ 60	Off <sup>c</sup>		±3.1° (nominal)	0.3°
> 41 to 44	≤ 60	Off <sup>c</sup>		±2.8° (nominal)	0.4°
> 3.0 to 20	≤ 80	Off <sup>c</sup>		±5.8°	0.5°
> 20 to 26.5	≤ 80	Off <sup>c</sup>		±5.8° (nominal)	0.7°
> 26.5 to 31.15	≤ 80	Off <sup>c</sup>		±7.0° (nominal)	0.6°
> 31.15 to 41	≤ 80	Off <sup>c</sup>		±6.3° (nominal)	0.5°
> 41 to 44	≤ 80	Off <sup>c</sup>		±6.2° (nominal)	0.6°

- a. This “typical” is the performance observed at the worst center frequency and worst offset frequency within the ranges shown in 80% of the instruments observed with 95% confidence. Agilent measures 100% of PSA analyzers for this performance in the factory production process. These performance results are not warranted.
- b. The listed performance is the rms of the phase deviation relative to the mean phase deviation from a linear phase condition, where the rms is computed over the range of offset frequencies and center frequencies shown.
- c. Option 123 is installed and enabled.

80 MHz Bandwidth Digitizer - Option 122  
Amplitude and Phase

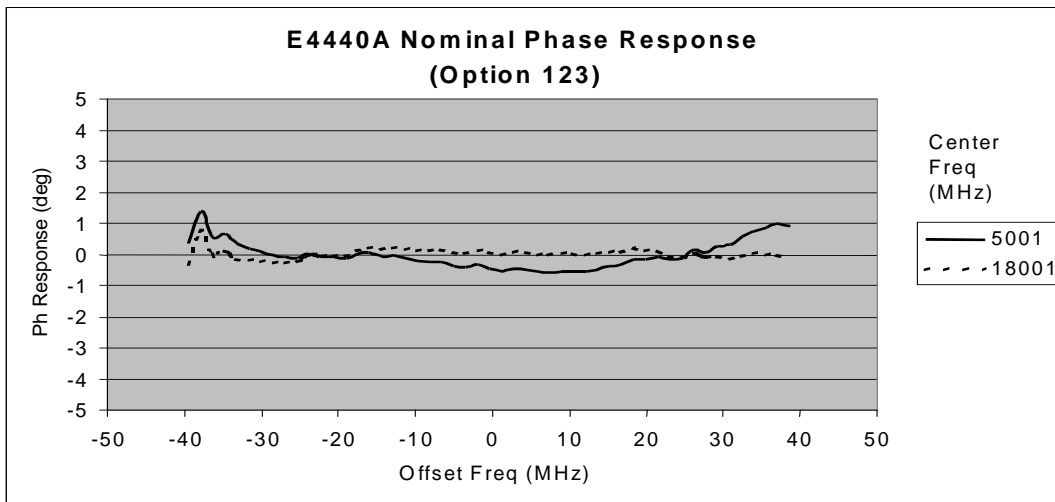
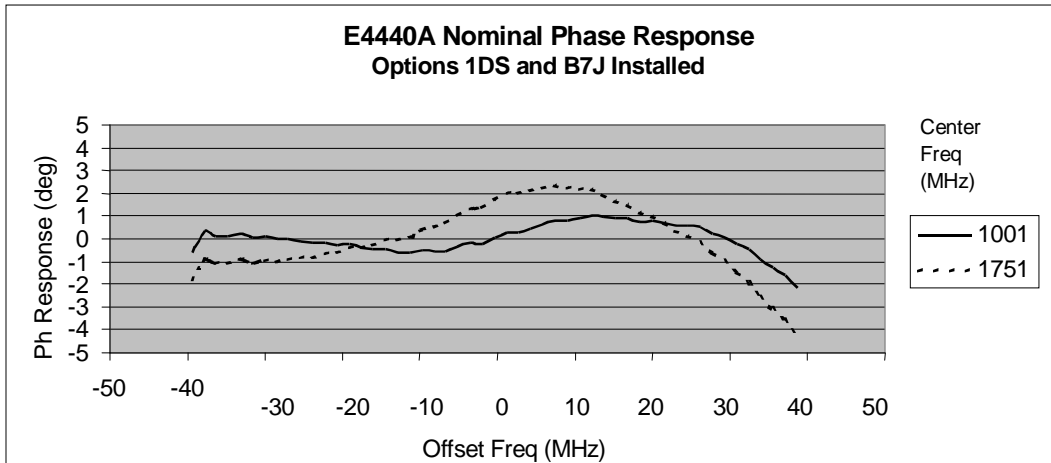
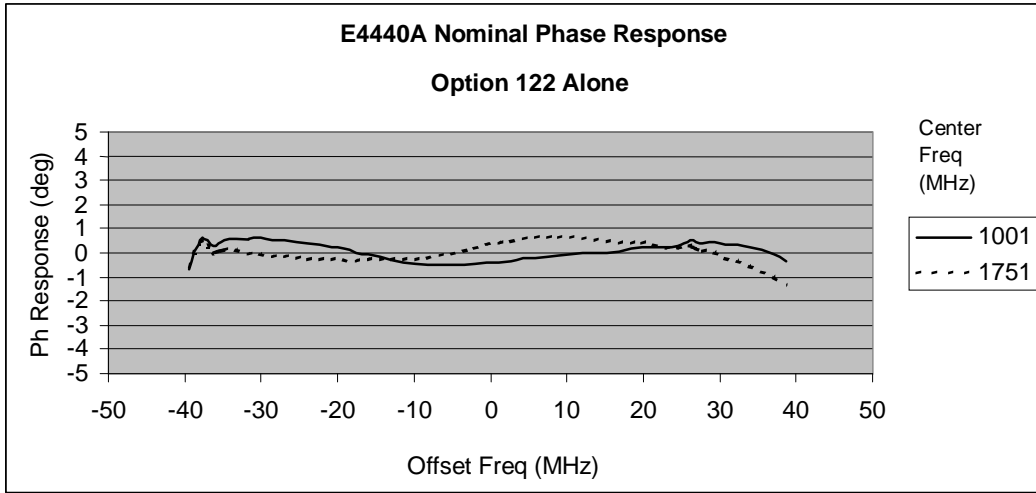

## Amplitude and Phase, Continued

Description	Specification	Supplemental Information		
<b>EVM</b>				
EVM measurement floor for an 802.11g OFDM signal, using 89601A software equalization, channel estimation and data EQ				
2.4 GHz		0.35% (nominal)		
6.0 GHz		0.56% (nominal)		
EVM measurement floor for a 62.5 Msymbol/sec QPSK signal, non-equalized, with 80 MHz occupied bandwidth		(nominal)		
		<i>Options</i>	<i>Option</i>	<i>No</i>
		<i>1DS, B7J<sup>a</sup></i>	<i>1DS<sup>b</sup></i>	<i>Options</i>
750 MHz		2.2%	1.5%	1.1%
2.5 GHz		2.1%	2.2%	2.0%
Preselector Off <sup>c</sup>				
3.05 GHz		1.6% (nominal)		
7.5 GHz		1.9% (nominal)		
10 GHz		1.5% (nominal)		
12.5 GHz		1.5% (nominal)		
18 GHz		1.6% (nominal)		
EVM measurement floor for a 50 Msymbol/sec QPSK signal, non-equalized, with 80 MHz occupied bandwidth, Root Raised Cosine filter (Alpha = 0.35). For E4446A/48A only		<i>Options</i>		
		<i>110 and B7J<sup>d</sup></i>		
17.5 GHz		2.4% (nominal)		
24 GHz		2.2% (nominal)		
29 GHz		4.2% (nominal)		
36 GHz		2.8% (nominal)		
43 GHz		3.1% (nominal)		

- a. The PSA is installed with Options 1DS and B7J but Option 1DS is Off.
- b. The PSA is installed with Option 1DS but not B7J. Option 1DS is Off.
- c. If the microwave preselector is required for measurements then an external source and the wide bandwidth digitizer external calibration wizard (*Option 235*) should be used. A complete description of the calibration wizard software can be found in *Application Note 1443*.
- d. The PSA is installed with Options 110 and B7J but Option 110 is Off.

## Dynamic Range

Description				Specifications	Supplemental Information
<b>Third Order Intermodulation Distortion</b>					Verified with 1 MHz separation
Two tones of equal magnitude, 0 dB IF Gain					
For E4440A/43A/45A					
<b>Freq</b>	<b>Span<sup>a</sup></b>	<b>Tone</b>	<b>Level<sup>b</sup></b>		
(GHz)	(MHz)	(dBfs)	(dBm)		
≤ 3.05	≤ 30	-9	-25	-75 dBc	-80 dBc (typical)
≤ 3.05	≤ 60	-9	-25	-74 dBc	-78 dBc (typical)
≤ 3.05	≤ 80	-9	-25		-78 dBc (nominal)
≤ 3.05	≤ 30	-6	-22	-72 dBc	-77 dBc (typical; equivalent to +16.5 dBm TOI)
≤ 3.05	≤ 60	-6	-22	-70 dBc	-74 dBc (typical)
≤ 3.05	≤ 80	-6	-22		-74 dBc (nominal)
Preselector On					
> 3.05	≤ 30	-6	-22		-68 dBc (nominal)
Preselector Off <sup>c</sup>					
> 3.0	≤ 30	-6	-22		-70 dBc (nominal)
For E4446A/ 48A					
<b>Freq</b>	<b>Span<sup>a</sup></b>	<b>Tone</b>	<b>Level<sup>b</sup></b>		
(GHz)	(MHz)	(dBfs)	(dBm)		
≤ 3.05	≤ 30	-9	-25	-75 dBc	-80 dBc (typical)
≤ 3.05	≤ 60	-9	-25	-74 dBc	-78 dBc (typical)
≤ 3.05	≤ 80	-9	-25		-73dBc (nominal)
≤ 3.05	≤ 30	-6	-22	-72 dBc	- 77dBc (typical; equivalent to + 16.5 dBm TOI)
≤ 3.05	≤ 60	-6	-22	-68 dBc	-74 dBc (typical)
≤ 3.05	≤ 80	-6	-22		-76 dBc (nominal)
Preselector On					

Description				Specifications	Supplemental Information
> 3.05 <sup>d</sup>	≤ 30	-4	-20		-65 dBc (nominal)
Preselector Off <sup>c</sup>					
> 3.0 <sup>d</sup>	≤ 30	-4	-20		-66 dBc (nominal)
<b>Spurious (Input Related) Responses</b>					Excludes second harmonic of RF input; see <a href="#">“Second Harmonic Distortion”</a> on page 74
Includes: aliased harmonic distortion, second-order IF intermodulation products, images about the center frequency. Preselector On.					
For E4440A/43A/45A					
<b>Freq</b>	<b>Span</b>	<b>Level</b>			
(GHz)	(MHz)	(dBfs)			
≤ 3.05	≤ 30	0	-73 dBc		-82 dBc (typical)
≤ 3.05	≤ 60	0	-65 dBc		-76 dBc (typical)
> 3.05	≤ 30	0			-68 dBc (nominal)
For E4446A/48A					
<b>Freq</b>	<b>Span</b>	<b>Level</b>			
(GHz)	(MHz)	(dBfs)			
≤ 3.05	≤ 30	0	-64 dBc		-74 dBc (typical)
≤ 3.05	≤ 60	0	-54 dBc		-65 dBc (typical)
> 3.05	≤ 30	0			-62 dBc (nominal)

- Specifications apply for the “best practices” case of using the central portion of the 36 and 80 MHz bandwidths. Noise and distortion performance degrade by about 4 dB at the edges of these bandwidths.
- Tone level; at mixer = RF Input level minus attenuation.
- Option 123 is installed and enabled.
- Up to 33 GHz. Above 33 GHz, the noise floor dominates the dynamic range specs.

80 MHz Bandwidth Digitizer - Option 122  
Dynamic Range

Description			Specifications	Supplemental Information
<b>Input Noise Density</b>				Excluding residuals;
<b>Freq (GHz)</b>	<b>Span (MHz)</b>	<b>IF Gain (dB)</b>		Preselector On, unless otherwise stated.
For E4440A/43A/45A				Non-option 123
≤ 3.05	≤ 30	-12	-136 dBfs/Hz	-140 dBfs/Hz <sup>a</sup> (nominal)
≤ 3.05	≤ 60	-12	-133 dBfs/Hz	
≤ 3.05	≤ 30	0	-130 dBfs/Hz	-134 dBfs/Hz (typical)
≤ 3.05	≤ 30	0	-130 dBfs/Hz	-137 dBfs/Hz @ 1 GHz (typical)
≤ 3.05	≤ 60	0	-130 dBfs/Hz	
3.0 to 6.6 <sup>b</sup>	≤ 30	0	-130 dBfs/Hz	-133 dBfs/Hz (typical)
For E4440A/43A/45A (Opt 110 preamp installed but Off)				Non-option 123.
≤ 3.05	≤ 30	-12	-135 dBfs/Hz	-139 dBfs/Hz <sup>a</sup> (nominal)
≤ 3.05	≤ 60	-12	-132 dBfs/Hz	
≤ 3.05	≤ 30	0	-129 dBfs/Hz	-133 dBfs/Hz (typical)
≤ 3.05	≤ 30	0	-129 dBfs/Hz	-136 dBfs/Hz @ 1 GHz (typical)
≤ 3.05	≤ 60	0	-129 dBfs/Hz	
3.0 to 6.6 <sup>b</sup>	≤ 30	0	-128 dBfs/Hz	-131 dBfs/Hz (typical)
				The following are nominal:
<b>Freq (GHz)</b>				Preselector On   Preselector Off <sup>b</sup>
3.05 to 6.6			≤30 MHz Span	≤60 MHz Span
			-135 dBfs/Hz	-135 dBfs/Hz
> 6.6 to 13.2			-132 dBfs/Hz	-128 dBfs/Hz
> 13.2 to 19.2			-132 dBfs/Hz	-123 dBfs/Hz
> 19.2 to 26.5			-128 dBfs/Hz	-116 dBfs/Hz
For E4446A/48A				
≤ 3.05	≤ 30	-12	-133 dBfs/Hz	-138 dBfs/Hz <sup>a</sup> (nominal)
≤ 3.05	≤ 60	-12	-130 dBfs/Hz	-138 dBfs/Hz (nominal)
≤ 3.05	≤ 30	0	-127 dBfs/Hz	-132 dBfs/Hz (typical)



Description			Specifications	Supplemental Information
≤ 3.05	≤ 60	0	-127 dBfs/Hz	-137 dBfs/Hz (nominal)
3.0 to 6.6 <sup>b</sup>	≤ 30	0	-125 dBfs/Hz	-128 dBfs/Hz (typical)
<b>Freq (GHz)</b>				The following are nominal:
				Preselector Off <sup>b</sup>
				≤60 MHz Span
3.0 to 6.6				-127 dBfs/Hz
> 6.6 to 13.2				-127 dBfs/Hz
> 13.2 to 19.2				-123 dBfs/Hz
> 19.2 to 26.5				-116 dBfs/Hz
> 26.5 to 31.15				-116 dBfs/Hz
> 31.15 to 41				-109 dBfs/Hz
> 41 to 50				-101 dBfs/Hz

- a. Specifications apply for the “best practices” case of using the central portion of the 36 and 80 MHz bandwidths. Noise and distortion performance degrade by about 4 dB at the edges of these bandwidths.
- b. Preselector is Off (Option 123 is installed and enabled).

80 MHz Bandwidth Digitizer - Option 122  
Dynamic Range

Description	Specifications	Supplemental Information
<p><b>Input Sensitivity (Noise level)</b></p> <p>Input terminated, log averaging, 0 dB input attenuation, freq <math>\leq</math> 3.05 GHz, maximum IF gain. Preselector On.</p> <p>For E4440A/43A/45A (Opt 1DS preamp installed but Off)</p> <p>For E4440A/43A/45A (Opt 110 preamp installed but Off)</p> <p>For E4446A/48A (Opt 1DS or 110 preamp installed but Off)</p>	<p style="text-align: center;">-152 dBm<sup>a b</sup></p> <p style="text-align: center;">-151 dBm<sup>a b</sup></p> <p style="text-align: center;">-149 dBm<sup>a b</sup></p>	<p>Excluding residuals.</p>

- a. This sensitivity is specified in a 1 Hz RBW, averaged on a log scale, much as is the Displayed Average Noise Level in chapter 1. The sensitivity in terms of noise density is 2.25 dB worse.
- b. Specifications apply for the “best practices” case of using the central portion of the 36 and 80 MHz bandwidths. Noise and distortion performance degrade by about 4 dB at the edges of these bandwidths.

Description	Specification	Supplemental Information																					
<p><b>Residual Responses</b></p> <p>Input terminated, 0 dB RF attenuation</p> <p>For E4440A/43A/45A</p> <p>Relative to Full-Scale<sup>a</sup></p> <table style="width: 100%; border-collapse: collapse;"> <tr> <td style="width: 20%;">Center Freq.</td> <td style="width: 20%;">Span</td> <td style="width: 60%;"></td> </tr> <tr> <td><math>\leq</math> 3.0 GHz,</td> <td><math>\leq</math> 80 MHz</td> <td style="text-align: center;">-90 dBfs</td> </tr> <tr> <td><math>&gt;</math>3.05 GHz and <math>&lt;</math>6.6 GHz</td> <td><math>\leq</math> 30 MHz</td> <td style="text-align: center;">-85 dBfs</td> </tr> <tr> <td><math>&gt;</math>3.0 GHz and <math>&lt;</math>6.6 GHz</td> <td><math>\leq</math> 80 MHz</td> <td style="text-align: center;">-75 dBfs (nominal, preselector off<sup>b</sup>)</td> </tr> </table> <p>For E4446A/48A</p> <p>Relative to Full-Scale<sup>a</sup></p> <table style="width: 100%; border-collapse: collapse;"> <tr> <td style="width: 20%;">Center Freq.</td> <td style="width: 20%;">Span</td> <td style="width: 60%;"></td> </tr> <tr> <td><math>\leq</math> 3.0 GHz,</td> <td><math>\leq</math> 80 MHz</td> <td style="text-align: center;">-90 dBfs</td> </tr> <tr> <td><math>&gt;</math> 3.05 GHz and <math>&lt;</math> 6.6 GHz</td> <td><math>\leq</math>30 MHz</td> <td style="text-align: center;">-85 dBfs</td> </tr> </table>	Center Freq.	Span		$\leq$ 3.0 GHz,	$\leq$ 80 MHz	-90 dBfs	$>$ 3.05 GHz and $<$ 6.6 GHz	$\leq$ 30 MHz	-85 dBfs	$>$ 3.0 GHz and $<$ 6.6 GHz	$\leq$ 80 MHz	-75 dBfs (nominal, preselector off <sup>b</sup> )	Center Freq.	Span		$\leq$ 3.0 GHz,	$\leq$ 80 MHz	-90 dBfs	$>$ 3.05 GHz and $<$ 6.6 GHz	$\leq$ 30 MHz	-85 dBfs		<p>Verified with IF Gain = -6 dB</p> <p>Preselector On</p> <p>Preselector On</p>
Center Freq.	Span																						
$\leq$ 3.0 GHz,	$\leq$ 80 MHz	-90 dBfs																					
$>$ 3.05 GHz and $<$ 6.6 GHz	$\leq$ 30 MHz	-85 dBfs																					
$>$ 3.0 GHz and $<$ 6.6 GHz	$\leq$ 80 MHz	-75 dBfs (nominal, preselector off <sup>b</sup> )																					
Center Freq.	Span																						
$\leq$ 3.0 GHz,	$\leq$ 80 MHz	-90 dBfs																					
$>$ 3.05 GHz and $<$ 6.6 GHz	$\leq$ 30 MHz	-85 dBfs																					

Description	Specification	Supplemental Information
> 3.0 GHz and ≤ 30 MHz < 6.6 GHz		-80 dBfs (nominal, preselector off <sup>b</sup> )
> 3.0 GHz and ≤ 80 MHz < 6.6 GHz		-72 dBfs (nominal, preselector off <sup>b</sup> )
<b>Frequency Stability</b> Noise Sidebands Center Frequency = 1 GHz, IF Gain = -12 dB For E4440A/43A/45A		
<b>Offset Frequency</b>		
100 Hz		-91 dBc/Hz (nominal)
1 kHz		-100 dBc/Hz (nominal)
10 kHz	-106 dBc/Hz	
100 kHz	-119 dBc/Hz	
1 MHz <sup>c</sup>	-135 dBc/Hz	
For E4446A/48A		
<b>Offset Frequency</b>		
100 Hz		-91 dBc/Hz (nominal)
1 kHz		-100 dBc/Hz (nominal)
10 kHz	-103 dBc/Hz	
100 kHz	-116 dBc/Hz	
1 MHz <sup>c</sup>	-135 dBc/Hz	

- a. The full scale level increases proportionally to input attenuation and decreases proportionally to IF gain. Full scale level (dBm) = -16 dBm + RF attenuation - IF gain where RF attenuation = 0, 2, 4, ..., 70 dB and IF gain = -12 to +12 dB.
- b. Option 123 is installed and enabled.
- c. The noise specified at this offset includes both contributors: the phase noise of the LO and the relative level of broadband input noise, with minimum IF gain and a signal at full scale, approximately -4 dBm at the input mixer.

---

## Data Acquisition

Description	Specifications	Supplemental Information
<b>Time Record Length</b>		
Spectrum Measurement	32 to 180,000 samples	32 to $10^6$ samples (nominal)
Waveform Measurement		
<b>Deep Time Capture</b>		
Analysis BW > 20 MHz	$1.2 \times 10^8$ samples	
Analysis BW $\leq$ 20 MHz	$6 \times 10^7$ samples	
<b>ADC Resolution</b>	14 Bits	

## Wideband IF Triggering

Description	Specification	Supplemental Information
<b>Trigger Types</b>	Free Run (immediate), Video (IF envelope), External Front, External Rear, Frame (periodic)	
<b>Frame (periodic) Trigger</b>		
Period		
Range	0 to > 500 ms	
Resolution	1 ns	
Offset Delay		
Range	0 to 10 s	
Resolution	10 ns	
Repeatability (when synchronized to an external source)		±10 ps jitter (nominal $\sigma$ )
<b>External Trigger</b>		
Trigger Delay		
Range	-100 ms to +500 ms	
Resolution	10 ns	
Repeatability		
Spectrum Mode (any span)		±1.5 ns (nominal $\sigma$ )
Waveform		
Analysis BW ≥ 6.25 MHz		±1.5 ns (nominal $\sigma$ )
Analysis BW < 6.25 MHz		±25 ns (nominal $\sigma$ )
Slope control, Input Impedance, Level Accuracy	See <a href="#">Chapter 1</a>	
<b>Video (IF Envelope) Trigger</b>		
Trigger Delay		
Range	0 to 500 ms	
Resolution	1 $\mu$ s	
Amplitude Range	0 to -80 dBfs	Usable range limited by noise

80 MHz Bandwidth Digitizer - Option 122  
**Wideband IF Triggering**

Description	Specification	Supplemental Information
<b>Trigger Hold off</b>  Range Resolution  <b>Auto Trigger</b>  Time Interval Range  <b>Time Averaging</b>  Maximum block size for frame-triggered averaging Maximum number of averages	0 to 500 ms  10 ns  1 ms to 10 s  16384 samples  > 500,000	Analysis BW $\leq$ 20 MHz



Description	Specification	Supplemental Information																					
<p><b>IF Frequency Response</b></p> <p>Relative to center frequency</p> <table border="1"> <thead> <tr> <th data-bbox="224 470 305 529">Freq (GHz)</th> <th data-bbox="386 470 467 529">Span (MHz)</th> <th data-bbox="565 470 695 495">Preselector</th> </tr> </thead> <tbody> <tr> <td data-bbox="224 554 315 579">3.0 – 20</td> <td data-bbox="386 554 509 579">≤ 36 MHz</td> <td data-bbox="565 554 607 579">On</td> </tr> <tr> <td data-bbox="224 604 315 630">3.0 – 20</td> <td data-bbox="386 604 509 630">≤ 64 MHz</td> <td data-bbox="565 604 607 630">On</td> </tr> <tr> <td data-bbox="224 655 315 680">3.0 – 20</td> <td data-bbox="386 655 509 680">≤ 80 MHz<sup>b</sup></td> <td data-bbox="565 655 607 680">On</td> </tr> <tr> <td data-bbox="224 705 315 730">3.0 – 20</td> <td data-bbox="386 705 509 730">≤ 36 MHz</td> <td data-bbox="565 705 623 730">Off<sup>c</sup></td> </tr> <tr> <td data-bbox="224 756 315 781">3.0 – 20</td> <td data-bbox="386 756 509 781">≤ 64 MHz</td> <td data-bbox="565 756 623 781">Off<sup>c</sup></td> </tr> <tr> <td data-bbox="224 806 315 831">3.0 – 20</td> <td data-bbox="386 806 509 831">≤ 80 MHz<sup>b</sup></td> <td data-bbox="565 806 623 831">Off<sup>c</sup></td> </tr> </tbody> </table>	Freq (GHz)	Span (MHz)	Preselector	3.0 – 20	≤ 36 MHz	On	3.0 – 20	≤ 64 MHz	On	3.0 – 20	≤ 80 MHz <sup>b</sup>	On	3.0 – 20	≤ 36 MHz	Off <sup>c</sup>	3.0 – 20	≤ 64 MHz	Off <sup>c</sup>	3.0 – 20	≤ 80 MHz <sup>b</sup>	Off <sup>c</sup>		<p>See “Nominal IF Frequency Response” on page 314 for peak response.</p> <p><b>Standard Deviation (nominal)<sup>a</sup></b></p> <p>0.018 dB</p> <p>0.039 dB</p> <p>0.093 dB</p> <p>0.015 dB</p> <p>0.032 dB</p> <p>0.067 dB</p>
Freq (GHz)	Span (MHz)	Preselector																					
3.0 – 20	≤ 36 MHz	On																					
3.0 – 20	≤ 64 MHz	On																					
3.0 – 20	≤ 80 MHz <sup>b</sup>	On																					
3.0 – 20	≤ 36 MHz	Off <sup>c</sup>																					
3.0 – 20	≤ 64 MHz	Off <sup>c</sup>																					
3.0 – 20	≤ 80 MHz <sup>b</sup>	Off <sup>c</sup>																					
<p><b>IF Phase Linearity</b></p> <p>Relative to mean phase linearity</p> <table border="1"> <thead> <tr> <th data-bbox="224 1052 305 1110">Freq (GHz)</th> <th data-bbox="386 1052 467 1110">Span (MHz)</th> <th data-bbox="565 1052 695 1077">Preselector</th> </tr> </thead> <tbody> <tr> <td data-bbox="224 1136 315 1161">3.0 – 20</td> <td data-bbox="386 1136 509 1161">≤ 36 MHz</td> <td data-bbox="565 1136 607 1161">On</td> </tr> <tr> <td data-bbox="224 1186 315 1211">3.0 – 20</td> <td data-bbox="386 1186 509 1211">≤ 64 MHz</td> <td data-bbox="565 1186 607 1211">On</td> </tr> <tr> <td data-bbox="224 1236 315 1262">3.0 – 20</td> <td data-bbox="386 1236 509 1262">≤ 80 MHz<sup>b</sup></td> <td data-bbox="565 1236 607 1262">On</td> </tr> <tr> <td data-bbox="224 1287 315 1312">3.0 – 20</td> <td data-bbox="386 1287 509 1312">≤ 36 MHz</td> <td data-bbox="565 1287 623 1312">Off<sup>c</sup></td> </tr> <tr> <td data-bbox="224 1337 315 1362">3.0 – 20</td> <td data-bbox="386 1337 509 1362">≤ 64 MHz</td> <td data-bbox="565 1337 623 1362">Off<sup>c</sup></td> </tr> <tr> <td data-bbox="224 1388 315 1413">3.0 – 20</td> <td data-bbox="386 1388 509 1413">≤ 80 MHz<sup>b</sup></td> <td data-bbox="565 1388 623 1413">Off<sup>c</sup></td> </tr> </tbody> </table>	Freq (GHz)	Span (MHz)	Preselector	3.0 – 20	≤ 36 MHz	On	3.0 – 20	≤ 64 MHz	On	3.0 – 20	≤ 80 MHz <sup>b</sup>	On	3.0 – 20	≤ 36 MHz	Off <sup>c</sup>	3.0 – 20	≤ 64 MHz	Off <sup>c</sup>	3.0 – 20	≤ 80 MHz <sup>b</sup>	Off <sup>c</sup>		<p><b>Standard Deviation (nominal)<sup>a</sup></b></p> <p>0.3 °</p> <p>0.8 °</p> <p>1.0 °</p> <p>0.1 °</p> <p>0.15 °</p> <p>0.4 °</p>
Freq (GHz)	Span (MHz)	Preselector																					
3.0 – 20	≤ 36 MHz	On																					
3.0 – 20	≤ 64 MHz	On																					
3.0 – 20	≤ 80 MHz <sup>b</sup>	On																					
3.0 – 20	≤ 36 MHz	Off <sup>c</sup>																					
3.0 – 20	≤ 64 MHz	Off <sup>c</sup>																					
3.0 – 20	≤ 80 MHz <sup>b</sup>	Off <sup>c</sup>																					

- a. The listed performance is the rms of the amplitude deviation from the center frequency amplitude, where the rms is computed over the range of offset frequencies and center frequencies shown, using an Agilent E8267C source.
- b. For Option 122 only.
- c. Option 123 is installed and enabled.



Description	Specification	Supplemental Information
<p><b>EVM</b></p> <p>EVM measurement floor for an 802.11g OFDM signal, using 89600A software equalization, channel estimation and data EQ</p> <p>2.4 GHz</p> <p>6.0 GHz</p> <p>EVM measurement floor for an 62.5 Msymbol/sec QPSK signal at 18.5 GHz. Adaptive Equalizer off.</p>		<p>0.35 % (nominal)</p> <p>0.56 % (nominal)</p> <p>1.50 %</p>

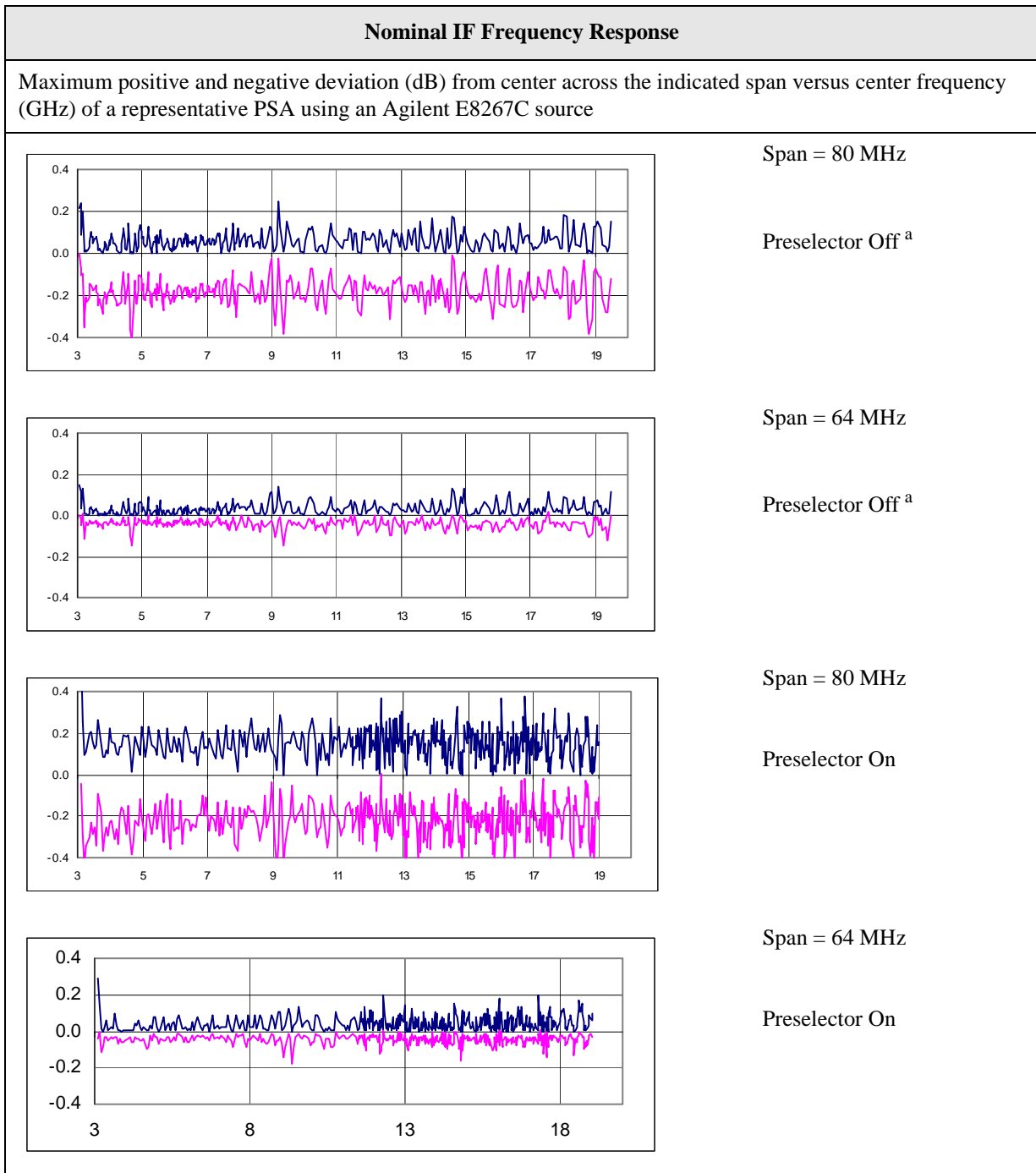

a. Option 123 is required.

## **Switchable MW Preselector Bypass Specifications**

This chapter contains specifications for the PSA series, Option 123, Switchable Microwave (MW) Preselector Bypass. When the preselector is bypassed, many performance characteristics of the analyzer are improved: >3.05 GHz amplitude accuracy, and wideband IF amplitude and phase flatness. The primary performance degradation is that images are no longer filtered.

## **Applicability of Specifications for this option**

When the Preselector Bypass option is installed and enabled, some aspects of the analyzer performance changes. This chapter shows some of those changes. The remaining changes are documented in other chapters.

### **Specifications in other chapters**

In [Chapter 18](#) , “[80 MHz Bandwidth Digitizer - Option 122](#),” the following specifications are affected when Option 123 is on (preselector bypassed):

- Frequency Span for Center Frequency > 3.05 GHz
- RF Frequency Response from 3.05 to 50 GHz
- IF Frequency Response
- IF Phase Linearity
- Third Order Intermodulation Distortion, Freq > 3.05 GHz

## Option 123, Switchable MW Preselector Bypass

### Frequency

Description	Specifications	Supplemental Information
<b>Frequency Range</b>		
E4440A	3.05 to 26.5 GHz	
E4443A	3.05 to 6.7 GHz	
E4445A	3.05 to 13.2 GHz	
E4446A	3.05 to 44 GHz	
E4447A	3.05 to 42.98 GHz	
E4448A	3.05 to 50 GHz	

### Image Responses

Description	Specifications	Supplemental Information
<b>Image Responses</b>		
Spacing		
Wide IF Path ( <i>Option 122</i> )		
Span $\leq$ 36 MHz	600.0 MHz	
Span $>$ 36 MHz	644.0 MHz	
Narrow IF Path	642.8 MHz	
Relative Level		0 dBc (nominal)

## Amplitude

### E4443A, E4445A, E4440A

Description	Specifications		Supplemental Information
<b>Displayed Average Noise Level (DANL)</b> Input terminated Sample or Average detector Averaging type = Log Normalized to 0 dB input attenuation, 1 Hz RBW			
	<b>20 to 30 °C</b>	<b>0 to 55 °C</b>	<b>Typical</b>
Preamp ( <i>Option 110</i> ) Off or Not Installed			
>3.05 to 6.6 GHz	-150 dBm		-153 dBm
6.6 to 13.2 GHz	-142 dBm		-146 dBm
13.2 to 19.2 GHz	-137 dBm		-140 dBm
19.2 to 26.5 GHz	-131 dBm		-134 dBm
Preamp Off ( <i>Option 110</i> installed)			<b>Typical</b>
>3.05 to 6.6 GHz	-148 dBm	-147 dBm	-151 dBm
6.6 to 13.2 GHz	-140 dBm	-139 dBm	-143 dBm
13.2 to 16 GHz	-136 dBm	-135 dBm	-140 dBm
16 to 19.2 GHz	-136 dBm	-135 dBm	-139 dBm
19.2 to 26.5 GHz	-129 dBm	-128 dBm	-130 dBm
Preamp On ( <i>Option 110</i> )			<b>Typical</b>
>3.05 to 6.6 GHz	-161 dBm	-159 dBm	-162 dBm
6.6 to 13.2 GHz	-152 dBm	-150 dBm	-155 dBm
13.2 to 16 GHz	-149 dBm	-146 dBm	-150 dBm
16 to 19.2 GHz	-146 dBm	-142dBm	-147 dBm
19.2 to 26.5 GHz	-138 dBm	-135 dBm	-140 dBm

Description	Specifications		Supplemental Information
<b>Frequency Response</b> 10 dB input attenuation			
Maximum error relative to reference condition (50 MHz)	<b>20 to 30 °C</b>	<b>0 to 55 °C</b>	<b>Typical</b> (at worst observed frequency)
>3.05 to 6.6 GHz	±0.9 dB	±1.5 dB	±0.25 dB
6.6 to 13.2 GHz	±1.0 dB	±2.0 dB	±0.4 dB
13.2 to 19.2 GHz	±1.3 dB	±2.0 dB	±0.5 dB
19.2 to 26.5 GHz	±2.3 dB	±3.0 dB	±0.9 dB
Additional frequency response error, FFT mode	See chapter 1, Amplitude Section, Frequency Response		
<b>Preamp On (Option 110)</b> 0 dB input attenuation			<b>Nominal</b>
>3.05 to 6.6 GHz			±1.0 dB
6.6 to 13.2 GHz			±1.0 dB
13.2 to 19.2 GHz			±1.0 dB
19.2 to 26.5 GHz			±1.5 dB

Switchable MW Preselector Bypass Specifications  
Amplitude

**E4447A, E4446A, E4448A**

Description	Specifications		Supplemental Information
<b>Displayed Average Noise Level (DANL)</b>			
Input terminated Sample or Average detector Averaging type = Log Normalized to 0 dB input attenuation, 1 Hz RBW			<b>Typical</b>
	<b>20 to 30 °C</b>	<b>0 to 55 °C</b>	
Preamp ( <i>Option 110</i> ) Off or Not Installed			
>3.05 to 6.6 GHz	-145 dBm	-144 dBm	-147 dBm
6.6 to 13.2 GHz	-145 dBm	-144 dBm	-149 dBm
13.2 to 19 GHz	-145 dBm	-144 dBm	-148 dBm
19 to 22.5 GHz	-136 dBm	-135 dBm	-142 dBm
22.5 to 26.8 GHz	-133 dBm	-132 dBm	-137 dBm
26.8 to 31.15 GHz	-136 dBm	-134 dBm	-139 dBm
31.15 to 35 GHz	-126 dBm	-125 dBm	-131 dBm
35 to 38 GHz	-126 dBm	-125 dBm	-131 dBm
38 to 41 GHz	-126 dBm	-125 dBm	-131 dBm
41 to 44 GHz	-119 dBm	-117 dBm	-123 dBm
44 to 45 GHz	-119 dBm	-117 dBm	-123 dBm
45 to 49 GHz	-113 dBm	-110 dBm	-117 dBm
49 to 50 GHz	-113 dBm	-110 dBm	-117 dBm
Preamp On ( <i>Option 110</i> )	<b>20 to 30 °C</b>	<b>0 to 55 °C</b>	
>3.05 to 6.6 GHz	-159 dBm	-157 dBm	-162 dBm
6.6 to 13.2 GHz	-157 dBm	-155 dBm	-160 dBm
13.2 to 19 GHz	-155 dBm	-153 dBm	-158 dBm
19 to 22.5 GHz	-146 dBm	-144 dBm	-150 dBm
22.5 to 26.8 GHz	-142 dBm	-140 dBm	-145 dBm
26.8 to 31.15 GHz	-141 dBm	-140 dBm	-142 dBm
31.15 to 35 GHz	-132 dBm	-130 dBm	-133 dBm



Description	Specifications		Supplemental Information
35 to 38 GHz	-132 dBm	-130 dBm	-133 dBm
38 to 41 GHz	-132 dBm	-130 dBm	-133 dBm
41 to 44 GHz	-123 dBm	-120 dBm	-127 dBm
44 to 45 GHz	-123 dBm	-120 dBm	-127 dBm
45 to 49 GHz	-112 dBm	-110 dBm	-118 dBm
49 to 50 GHz	-112 dBm	-110 dBm	-118 dBm

Description	Specifications		Supplemental Information
<b>Frequency Response</b> 10 dB input attenuation  Maximum error relative to reference condition (50 MHz)	<b>20 to 30 °C</b>	<b>0 to 55 °C</b>	<b>Typical</b> (at worst observed frequency)
>3.05 to 6.6 GHz	±1.0 dB	±2.0 dB	±0.5 dB
6.6 to 13.2 GHz	±1.0 dB	±3.0 dB	±0.5 dB
13.2 to 19.2 GHz	±1.3 dB	±3.0 dB	±0.5 dB
19.2 to 26.8 GHz	±1.5 dB	±3.0 dB	±0.6 dB
26.8 to 31.15 GHz	±1.5 dB	±3.5 dB	±0.6 dB
31.15 to 41 GHz	±1.5 dB	±3.0 dB	±0.7 dB
41 to 50 GHz	±2.5 dB	±4.5 dB	±1.0 dB
Additional frequency response error, FFT mode	See <a href="#">“Frequency Response” on page 56</a>		

Switchable MW Preselector Bypass Specifications  
**Amplitude**

Description	Specifications	Supplemental Information
Preamp On ( <i>Option 110</i> ) 0 dB input attenuation		<b>Nominal</b>
>3.05 to 6.6 GHz		±2.0 dB
6.6 to 13.2 GHz		±1.5 dB
13.2 to 19.2 GHz		±1.5 dB
19.2 to 26.8 GHz		±2.0 dB
26.8 to 31.15 GHz		±2.0 dB
31.15 to 41 GHz		±2.0 dB
41 to 50 GHz		±2.0 dB

## Dynamic Range

Description	Specifications	Supplemental Information
<b>Second Harmonic Distortion</b> Source Freq = 1.5 to 13.25 GHz		<b>Intercept</b> +30 dBm (nominal)
<b>Third Order Intermodulation Distortion</b> 3.05 to 6.6 GHz 6.6 to 7.7 GHz 7.7 to 21.5 GHz 21.5 to 26.5 GHz		<b>Intercept</b> +23 dBm (nominal) +16 dBm (nominal) +20 dBm (nominal) +23 dBm (nominal)
<b>1 dB Gain Compression Point (Two-tone)</b> 3.05 to 26.5 GHz		<b>Power at mixer<sup>a</sup></b> +8 dBm (nominal)

a. Mixer level = Input Level – Input Attenuation

## First LO Emission Level

### E4443A, E4445A, E4440A

Description	Specifications	Supplemental Information
First LO Emission Level w/Preselector bypassed		$\leq (-27 \text{ dBm} - \text{input attenuation})$ (nominal) $F_{\text{Emission}} = \text{Center frequency} + 321.4 \text{ MHz}$

### E4447A, E4446A, E4448A

Description	Specifications	Supplemental Information
First LO Emission Level w/Preselector bypassed		$\leq (-3 \text{ dBm} - \text{input attenuation})$ (nominal) $F_{\text{Emission}} = \text{Center frequency} + 321.4 \text{ MHz}$

Switchable MW Preselector Bypass Specifications  
**Dynamic Range**



---

## Applicability of Specification for this Option

When the Y-axis Video Output option is installed and enabled, it does not affect any other specifications.

### Operating Conditions

Description	Specifications	Supplemental Information
<b>Operating Conditions</b>		
Display Scale Types	All (Log and Lin)	"Lin" is linear in voltage
Log Scales	All (0.1 to 20 dB/div)	
Modes	Spectrum Analyzer only	
FFT & Sweep	FFTs may not be on. Select swept mode zero span	
Gating	Gating must be off	
<i>Option 122</i> 80 MHz Bandwidth Digitizer	<i>Option 122</i> must be absent or disabled by setting the IF Path to Narrow	

**Output Signal**

Description	Specifications	Supplemental Information
<p><b>Output Signal</b></p> <p>Replication of the RF Input Signal envelope, as scaled by the display settings</p> <p>Differences between display effects and video output</p> <p>Detectors other than Average</p> <p>Average Detector</p> <p>Trace Averaging</p>	<p>The output signal represents the input envelope excluding display detection</p> <p>The effect of average detection in smoothing the displayed trace is approximated by the application of a low-pass filter</p> <p>Trace averaging affects the displayed signal but does not affect the video output</p>	<p>Nominal bandwidth:</p> $LPFBW = \frac{Npoints - 1}{SweepTime \cdot \pi}$

## Amplitude

Description	Specifications	Supplemental Information
<b>Amplitude Range</b>		Range of represented signals
Minimum	Bottom of screen	
Maximum	Top of Screen + Overrange	
Overrange		Smaller of 2 dB or 1 division, (nominal)
<b>Output Scaling<sup>a</sup></b>	0 to 1.0 V open circuit, representing bottom to top of screen	
Offset		±1 % of full scale (nominal)
Gain accuracy		±1 % of output voltage (nominal)
<b>Output Impedance</b>		140 Ω (nominal)

- a. The errors in the output can be described as offset and gain errors. An offset error is a constant error, expressed as a fraction of the full-scale output voltage. The gain error is proportional to the output voltage. Here's an example. The reference level is -10 dBm, the scale is log, and the scale is 5 dB/division. Therefore, the top of the display is -10 dBm, and the bottom is -60 dBm. Ideally, a -60 dBm signal gives 0 V at the output, and -10 dBm at the input gives 1 V at the output. The maximum error with a -60 dBm input signal is the offset error, ±1 % of full scale, or ±10 mV; the gain accuracy does not apply because the output is nominally at 0 V. If the input signal is -20 dBm, the nominal output is 0.8 V. In this case, there is an offset error (±10 mV) plus a gain error (±1 % of 0.8 V, or ±8 mV), for a total error of ±18 mV.



---

## Delay

Description	Specifications	Supplemental Information
Delay from signal at RF Input to Video Output		$1.67 \mu\text{s} + 2.56/\text{RBW} + 0.159/\text{VBW}$ (nominal)

## Continuity and Compatibility

Description	Specifications	Supplemental Information
<b>Output Tracks Video Level</b>		
During sweep	yes	Except band breaks in swept spans
Between sweeps	See supplemental information	Before sweep interruption <sup>a</sup> Alignments <sup>b</sup> Quick cals <sup>c d</sup>
External trigger, no trigger <sup>d</sup>	Yes	
<b>HP 8566/7/8 Compatibility</b>		Recorder output labeled “Video”
Continuous output		Alignment differences <sup>e</sup>
Output impedance		Two variants <sup>f</sup>
Gain calibration		LL and UR not supported <sup>g</sup>
RF Signal to Video Output Delay		See footnote <sup>h</sup>

- a. There is an interruption in the tracking of the video output before each sweep. During this interruption, the video output holds instead of tracks for a time period given by approximately  $1.8/\text{RBW}$ .
- b. There is an interruption in the tracking of the video output during alignments. During this interruption, the video output holds instead of tracking the envelope of the RF input signal. Alignments may be set to Off or Alert to prevent their interrupting video output tracking.
- c. Frequent “quick cals” can also set the video output to hold between sweeps. These alignments are brief but are not disabled by turning Alignments to Off or Alert.
- d. If video output interruptions for “quick cals” are unacceptable, setting the analyzer to External Trigger without a trigger present can prevent these from occurring, but will prevent there being any on-screen updating. Video output is always active even if the analyzer is not sweeping.
- e. The HP 8566 family did not have alignments and interruptions that interrupted video outputs, as discussed above.
- f. Early HP 8566-family spectrum analyzers had a  $140\ \Omega$  output impedance; later ones had  $190\ \Omega$ .
- g. The HP 8566 family had LL (lower left) and UR (upper right) controls that could be used to calibrate the levels from the video output circuit. These controls are not available in Option 124.
- h. The delay between the RF input and video output shown above is much higher than the delay in the HP 8566 family spectrum analyzers. The latter has a delay of approximately  $0.554/\text{RBW} + 0.159/\text{VBW}$ .

---

## **22 W-LAN Measurement Personality**

This chapter contains specifications for the PSA series, Option 217, WLAN measurement personality.

## OFDM Analysis (802.11a, 802.11g OFDM)

### Frequency

Description	Specification	Supplemental Information
<b>Frequency Range</b>		
E4443A	36 MHz to 6.7 GHz	
E4445A	36 MHz to 13.2 GHz	
E4440A	36 MHz to 26.5 GHz	
E4446A	36 MHz to 44 GHz	
E4448A	36 MHz to 50 GHz	
Frequency Span (analysis bandwidth)		
with <i>Option 122</i>	10 Hz to 80 MHz	
with <i>Option 140</i>	10 Hz to 40 MHz	
Frequency Setting Methods		
	Center frequency	
	Channel number	

### Amplitude

Description	Specification	Supplemental Information
<b>Amplitude Range</b>		
E4443A, E4445A, E4440A E4446A, E4448A		-50 dBm to +11 dBm (nominal) (depends on input attenuation and IF gain settings)

## Signal Acquisition

Description	Specification	Supplemental Information
Supported Standards	802.11a, 802.11g OFDM	
Modulation Formats	BPSK, QPSK, 16QAM, 64QAM	(auto detect or manual override)
Capture length (20 MHz span)	5.12 seconds	
Result length	auto detect or adjustable	
Triggering	free-run/video/external frame	Single or continuous
Measurement region	Length and offset adjustable within result length	

## Display Formats

Description	Specification	Supplemental Information
<b>Demodulation results</b>		
	I/Q constellation	
Numeric Results	Error vector	Time, spectrum
	RMS Error vector	Time, spectrum
	Transmit power	Average, peak
	EVM	Average, max
	IQ offset	
	Gain imbalance	
	Quadrature error	
	Center frequency error	
	Symbol clock error	
Spectrum	Demod bits	
	Spectrum emission mask	
	Spectrum flatness	
	Spectrum FFT	
CCDF	Graph	
	Average power	
	Peak power	

---

## Adjustable Parameters

Description	Specification	Supplemental Information
<b>Data Format</b>	802.11a, 802.11g OFDM	
<b>Single Button Presets</b>	802.11a, 802.11g ERP-OFDM, 802.11g DSSS-OFDM	
<b>Sub-carrier spacing</b>	312.5 kHz	User settable
<b>Pilot tracking</b>	Phase, amplitude, timing	
<b>Equalizer training</b>	channel estimation sequence, channel estimation sequence and data	

## Accuracy

Description	Specification	Supplemental Information
<b>Absolute Amplitude Accuracy</b>	20 to 30 °C	Typical unless otherwise stated.
WLAN measurement personality mode		
Center frequency = 2.442 GHz (For E4443A/45A/40A)	± 1.48 dB	± 0.74 dB (span = 40 MHz)
Center frequency = 2.442 GHz (For E4446A/48A)	± 2.52 dB	±1.27 dB (span = 40 MHz)
Center frequency = 5.240 GHz (For E4443A/45A/40A)	± 1.78 dB	± 0.71 dB (span = 40 MHz, preselector off) <sup>a</sup>
Center frequency = 5.240 GHz (For E4446A/48A)		±1.41 dB (span = 40 MHz, preselector off) <sup>a</sup>
Spectrum analysis mode		
Center frequency = 2.442 GHz (For E4443A/45A/40A)	± 0.86 dB	± 0.17 dB
Center frequency = 2.442 GHz (For E4446A/48A)	± 0.98 dB	±0.21 dB
Center frequency = 5.240 GHz (For E4443A/45A/40A)	± 1.19 dB	± 0.26 dB (preselector off) <sup>a</sup>
Center frequency = 5.240 GHz (For E4446A/48A)	± 2.28 dB	±0.56 dB ( preselector off) <sup>a</sup>
Relative power accuracy (For E4443A/45A/40A)	± 0.30 dB	
Relative power accuracy (For E4446A/48A)		±0.30 dB (nominal)

a. Option 123 is installed and enabled.

Description	Specification	Supplemental Information
<b>Modulation Accuracy</b>		
Residual EVM (20 averages)		
802.11g signal, 54 Mbps data rate, payload data = PN9 sequence		
Equalizer training = channel estimation sequence and data		<-48 dB (0.40 %) (nominal)



Description	Specification	Supplemental Information
Equalizer training = channel estimation sequence		<-45 dB (0.56 %) (nominal)
Spectral flatness uncertainty		± 0.75 dB (nominal)
Center frequency leakage		<-48 dB (nominal)
Frequency lock range		±625kHz (±2 × sub-carrier spacing, nominal)
<b>Frequency Accuracy</b>		
Transmit center frequency accuracy		±5 Hz (nominal)
Symbol clock frequency readout error		< 0.9 ppm (nominal)

## DSSS/CCK/PBSS Analysis (802.11b, 802.11g)

### Frequency

Description	Specification	Supplemental Information
<b>Frequency Range</b>		
E4443A	36 MHz to 6.7 GHz	
E4445A	36 MHz to 13.2 GHz	
E4440A	36 MHz to 26.5 GHz	
E4446A	36 MHz to 44 GHz	
E4448A	36 MHz to 50 GHz	
<b>Frequency Span (analysis bandwidth)</b>		
with <i>Option 122</i>	10 Hz to 80 MHz	
with <i>Option 140</i>	10 Hz to 40 MHz	
<b>Frequency Setting Methods</b>		
	Center frequency	
	Channel number	

### Amplitude

Description	Specification	Supplemental Information
<b>Amplitude Range</b>		
E4443A, E4445A, E4440A, E4446A, E4448A		-50 dBm to +11 dBm (nominal) (depends on input attenuation and IF gain settings)

## Signal Acquisition

Description	Specification	Supplemental Information
<b>Supported Standards</b>  <b>Modulation Formats</b>  <b>Preamble</b> Capture Length (22 MHz span) Result length Triggering Measurement region	802.11b, 802.11g DSSS/CCK/PBCC  Barker1, Barker2, CCK5.5, CCK11, PBCC5.5, PBCC11, PBCC22, PBCC33  Auto detect (short, long)  4.65 seconds  auto detect or adjustable  free-run/video/external frame  Length and offset adjustable within result length	(auto detect or manual override)

## Display Formats

Description	Specification	Supplemental Information
<b>Demodulation Results</b>	I/Q constellation Error vector	Time
<b>Numeric Results</b>	Transmit power EVM, 100-chip peak EVM Magnitude error Phase error IQ offset Gain imbalance Quadrature error Center frequency error Chip clock error Demod bits	Average, peak Average, max Average, max Average, max
<b>Spectrum</b>	Spectrum emission mask Spectrum flatness Power-on ramp time Power-down ramp time CCDF	

## Adjustable Parameters

Description	Specification	Supplemental Information
Data Format	802.11b including optional short preamble and optional PBCC modes, 802.11g including PBCC22 and PBCC33 modes	
Single Button Presets	802.11b DSSS/CCK/PBCC, 802.11g ERP-DSSS/CCK, 802.11g ERP-PBCC	
Tracking	Phase	
Equalizer	On/Off	
Equalizer Filter Length	3-99 chips	
Descrambler Mode	On/Off, preamble only, preamble, header only	

## Accuracy

Description	Specification	Supplemental Information
<b>Absolute Amplitude Accuracy</b>	20 to 30 °C	Typical unless otherwise stated.
WLAN measurement personality mode Center frequency = 2.442 GHz (For E4443A/45A/40A)	± 1.48 dB	± 0.74 dB (span = 40 MHz)
Center frequency = 2.442 GHz (For E4446A/48A)	± 2.52 dB	±1.27 dB (span = 40 MHz)
Spectrum analysis mode Center frequency = 2.442 GHz (For E4443A/45A/40A)	± 0.86 dB	± 0.17 dB
Center frequency = 2.442 GHz (For E4446A/48A)	± 0.98 dB	±0.21 dB
<b>Relative Power Accuracy</b> (For E4443A/45A/40A)	± 0.30 dB	
<b>Relative Power Accuracy</b> (For E4446A/48A)		± 0.30 dB (nominal)
<b>Modulation Accuracy</b>		
Residual EVM (10 averages, ref filter = transmit filter)		
Data rate = 11 Mbps, payload data = PN9 sequence		
Equalizer on		< 0.4 % (–48 dB) (nominal)
Equalizer off		< 1.0 % (–40 dB) (nominal)

Description	Specification	Supplemental Information
<b>Frequency Lock Range</b>		$\pm 2.5$ MHz (nominal)
<b>Frequency Accuracy</b>		$\pm 5$ Hz (nominal)
Transmit Center Frequency Accuracy		
Chip clock frequency readout error		$< 6$ % (nominal)
Transmit RF carrier suppression (center frequency leakage)		$< -41$ dB (nominal)
Transmit power up ramp time resolution error		$< 1.6$ $\mu$ s (nominal)
Transmit power down ramp time resolution error		$< 1.6$ $\mu$ s (nominal)

## Conformance for 802.11a and 802.11g ERP-OFDM/DSSS-OFDM Standard

Section 17.3.	Test Name	PICS Item	Test Limit		Link to Option 217 Specification	Specifications
9.1	Transmit power	OF4.1 (OF4.1.1-OF4.1.3)	Center freq 5.15–5.25GHz 5.25–5.35GHz 5.725–5.825 GHz	Maximum Tx power 40mW (2.5mW/MHz) 200mW (12.5mW/MHz) 800 mW (50 mW/MHz)	Amp accuracy	Hard
9.2	Transmit spectrum mask	OF4.2	0 dBr < 18 MHz BW ( $\pm 9$ M offset) –20 dBr at $\pm 11$ M offset –28 dBr at $\pm 20$ M offset –40 dBr at $\pm 30$ M offset Note: dBr (relative to max PSD of signal)		Dynamic range Relative accuracy	Hard (or N/A)
9.3	Transmit spurious	OF4.3	Conformance to national regulations		Not in option 217. Use Power Suite spurious function	N/A
9.4	Transmit center frequency tolerance	OF4.4	$\pm 20$ ppm for 802.11a $\pm 25$ ppm for 802.11g CF = 5.180GHz, $\pm 103.6$ kHz (11a) CF = 2.412GHz, $\pm 60.3$ kHz (11g)		Freq error	Nominal
9.5	Symbol clock frequency tolerance	OF4.5	$\pm 20$ ppm for 802.11a ( $\pm 5$ kHz) $\pm 25$ ppm for 802.11g ( $\pm 6.25$ kHz) Symbol rate = 250Msym/s		Symbol clock error	Nominal
9.6.1	Transmit center frequency leakage	OF4.6.1	< –15 dB relative to overall Tx power		IQ offset	Nominal



W-LAN Measurement Personality  
**Conformance for 802.11a and 802.11g ERP-OFDM/DSSS-OFDM Standard**

Section 17.3.	Test Name	PICS Item	Test Limit		Link to Option 217 Specification	Specifi- cations
9.6.2	Transmit spectral flatness	OF4.6.2	$\pm 2$ dB for $\pm 16$ sub-carriers and within $+2/-4$ dB for all sub-carriers.		Relative accuracy	Nominal
9.6.3	Transmit constellation error (EVM)	OF4.6.3 - OF4.6.10	Data Rate (Mbps)	RMS EVM (dB)	Residual EVM EVM accuracy	Nominal
			6	-5		
			9	-8		
			12	-10		
			18	-13		
			24	-16		
			36	-19		
			48	-22		
			54	-25		

## Conformance for 802.11b and 802.11g ERP-DSSS/CCK/PBCC Standard

Section 18.4.	Test Name	PICS Item	Test Limit	Link to Option 217 Spec.	Specifications
7.1	Transmit power	HRDS14 HRDS21	< 1000 mW	Amp accuracy	Hard
7.2	Transmit power control	HRDS14 HRDS21	Power control provided for Tx power > 100 mW	N/A	N/A
7.3	Transmit spectrum mask	HRDS22	-0 dBr < 22MHz BW ( $\pm$ 11M offset) -30 dBr from $\pm$ 11M to $\pm$ 22M offset -50 dBr at $\pm$ 22M offset Note: dBr (relative to max PSD of signal)	Dynamic range Relative accuracy	Hard (or N/A)
7.4	Transmit center frequency tolerance	HRDS23	$\pm$ 25 ppm CF = 2.412GHz, $\pm$ 60.3 kHz	Freq error	Nominal
7.5	Chip clock frequency tolerance	HRDS24	$\pm$ 25 ppm ( $\pm$ 275 Hz) Chip rate = 11Mcps	Chip clock error	Nominal
7.6	Transmit power-on and power-off ramp	HRDS25 HRDS26	Power-on ramp: $\leq$ 2 $\mu$ s for 10% to 90% of max power Power-down ramp: $\leq$ 2 $\mu$ s for 90% to 10% of max power	Time resolution Time accuracy	Nominal
7.6	RF carrier suppression	HRDS27	< -15 dB relative to peak PSD	IQ offset	Nominal
7.7	Transmit modulation accuracy	HRDS28	802.11b 1000-chip Peak EVM < 0.35 EVM (RMS) < 0.16	Residual EVM EVM accuracy	Nominal

---

## **23 External Source Control - Option 215**

This chapter contains specifications for the PSA series, Option 215, External Source Control.

Description	Specification	Supplemental Information
<p><b>Frequency</b></p> <p>Operating range</p> <p><b>Span Limitations</b></p> <p>Span limitations due to source range</p> <p>Span limitations due to analyzer band crossing</p> <p><b>Offset Sweep</b></p> <p>Sweep offset setting range</p> <p>Sweep offset setting resolution</p> <p><b>Harmonic Sweep</b></p> <p>Harmonic sweep setting range</p> <p><b>Sweep Direction<sup>d</sup></b></p>	<p>3 Hz to 50 GHz</p> <p>1 Hz</p>	<p>PSA frequency bands</p> <p>Band 0: 3 Hz to 3.05 GHz            Band 1: 2.85 to 6.6 GHz            Band 2: 6.2 to 13.2 GHz            Band 3: 12.8 to 19.2 GHz            Band 4: 18.7 to 26.8 GHz            Band 5: 26.4 to 31.15 GHz            Band 6: 31.0 to 50 GHz</p> <p>See note <sup>a</sup></p> <p>See note <sup>b</sup></p> <p>Limited by the source and SA operating range</p> <p>N= 0.1 to 10<sup>c</sup></p> <p>Normal, Reversed</p>

- a. The available span will be limited by the requirement that the start and stop frequencies be one point-spacing inside of the source range limitations. A point-spacing is given by the Span divided by (Points – 1) where Points is the number of sweep points. For example: Span = 100 MHz, Points = 101, point-spacing is 1 MHz. A source with a 0.1 MHz to 4 GHz range could only support start frequencies of 1.1 MHz or more, and stop frequencies of 3.999 GHz or less.
- b. The available span will be limited by the requirement that the start and stop frequencies be within the same harmonic mixing band of the spectrum analyzer. As shown in the table of PSA frequency bands, for frequencies up through 26 GHz, a span of 200 MHz or less is always possible without changing harmonic mixing bands. Wider spans are available at most frequencies, including as an example from near 0 Hz to 3.05 GHz, or another example from 2.85 to 6.6 GHz.
- c. Limited by the frequency range of the source to be controlled.
- d. The analyzer always sweeps in a positive direction, but the source may be configured to sweep in the opposite direction. This can be useful for analyzing negative mixing products in a mixer under test, for example.

Description	Specification	Supplemental Information															
<p><b>Dynamic Range</b></p> <p>10 MHz to 3 GHz, Input terminated, sample detector, average type = log, 20 °C to 30 °C</p> <table border="1"> <thead> <tr> <th>PSA span</th> <th>PSA RBW</th> <th>Specification</th> </tr> </thead> <tbody> <tr> <td>1 MHz</td> <td>2 kHz</td> <td>108.9 dB</td> </tr> <tr> <td>10 MHz</td> <td>6.8 kHz</td> <td>103.6 dB</td> </tr> <tr> <td>100 MHz</td> <td>20 kHz</td> <td>98.9 dB</td> </tr> <tr> <td>1000 MHz</td> <td>68 kHz</td> <td>93.6 dB</td> </tr> </tbody> </table> <p><b>Amplitude Accuracy</b></p>	PSA span	PSA RBW	Specification	1 MHz	2 kHz	108.9 dB	10 MHz	6.8 kHz	103.6 dB	100 MHz	20 kHz	98.9 dB	1000 MHz	68 kHz	93.6 dB		<p>Dynamic Range = <math>-10 \text{ dBm} - \text{DANL} - 10 \times \log(\text{RBW})^a</math></p> <p>Multiple contributors: <sup>b</sup></p> <p>Linearity <sup>c</sup></p> <p>Source and Analyzer Flatness <sup>d</sup></p> <p>YTF Instability <sup>e</sup></p> <p>VSWR effects <sup>f</sup></p>
PSA span	PSA RBW	Specification															
1 MHz	2 kHz	108.9 dB															
10 MHz	6.8 kHz	103.6 dB															
100 MHz	20 kHz	98.9 dB															
1000 MHz	68 kHz	93.6 dB															

- a. The dynamic range is given by this computation:  $-10 \text{ dBm} - \text{DANL} - 10 \times \log(\text{RBW})$  where DANL is the displayed average noise level specification, normalized to 1 Hz RBW, and the RBW used in the measurement is in hertz units. The dynamic range can be increased by reducing the RBW at the expense of increased sweep time. The sweep time increase will be approximately 3.2 times Span divided by RBW<sup>2</sup>. The sweep time may not exceed 2000 s, which means the RBW cannot be less than the square root of span divided by 625 s.
- b. The following footnotes discuss the biggest contributors to amplitude accuracy.
- c. One amplitude accuracy contributor is the linearity with which amplitude levels are detected by the PSA. This is called "scale fidelity" by most spectrum analyzer users, and "dynamic amplitude accuracy" by most network analyzer users. This small term is documented in the Amplitude section of the Specifications Guide. It is negligibly small in most cases.
- d. The amplitude accuracy versus frequency in the source and the analyzer can contribute to amplitude errors. This error source is eliminated when using normalization in low band (0 to 3.05 GHz). In high band, unless the preselector bypass option is installed and used, the gain instability of the YIG-tuned prefilter in the PSA keeps normalization errors nominally in the 0.25 to 0.5 dB range.
- e. In the worst case, the center frequency of the YIG-tuned prefilter can vary enough to cause very substantial errors, much higher than the nominal 0.25 to 0.5 dB nominal errors discussed in the previous footnote. In this case, or as a matter of good practice, the prefilter should be centered. See the user's manual for instructions on centering the preselector.
- f. VSWR interaction effects, caused by RF reflections due to mismatches in impedance, are usually the dominant error source. These reflections can be minimized by using 10 dB or more attenuation in the PSA, and using well-matched attenuators in the measurement configuration.

Description	Specification	Supplemental Information
<b>Power sweep range</b>		0 to $\pm 30 \text{ dB}$ (Nominal) <sup>a</sup>

- a. Relative to the original power level and limited by the source to be controlled.

Description	Specification	Supplemental Information
<p><b>Measurement Time</b></p> <p>RBW setting of the PSA determined by the default for Option 215</p> <p>101 Sweep points</p> <p>601 Sweep points</p> <p>101 Sweep points</p> <p>601 Sweep points</p>		<p>Nominal <sup>a</sup></p> <p>ESG or PSG <sup>b</sup></p> <p>2.9 s</p> <p>9.5 s</p> <p>MXG<sup>c</sup></p> <p>1.1 s</p> <p>1.9 s</p>

- a. These measurement times were observed with a span of 100 MHz and the automatically selected setting of RBW, which is 20 kHz. The measurement times will not change significantly with span when the RBW is automatically selected. If the RBW is decreased, the measurement time will go up by approximately 3.2 times Span divided by RBW<sup>2</sup>.
- b. Based on ESG firmware version C.03.72 or PSG firmware version C.04.04.
- c. Based on MXG firmware version A.01.41.









## Applicability of Specifications for this Option

This chapter of the specifications guide describes the unique performance of the CISPR 16-1-1 compliant EMI Receiver, the combination of PSA and RF Preselector (N9039A). When the RF Preselector is installed and enabled, aspects of the base PSA spectrum analyzer performance are affected as described by this chapter.

**Figure 24-1** EMI Receiver Block Diagram

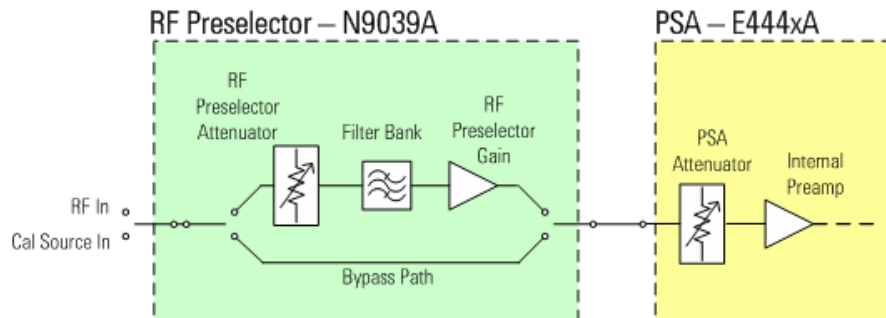

The EMI Receiver has two paths: preselected (up to 1 GHz) and bypass (available through 26.5 GHz).

- Input attenuator in PSA is fixed at 10 dB when making preselected measurements using the N9039A. The RF preselector has 57.5 dB of available attenuation in front of the PSA.
- The RF Preselector Gain is set to OFF by default.
- RF Preselector Gain is used solely for preselected sweeps to increase sensitivity.
- Any signal sent through the RF preselector has a minimum of 10 dB gain. When the RF Preselector Gain is set to ON, an additional 15 dB gain is available. This gain is available in the preselected path alone.
- Standard PSA features are available in bypass path.
- Optional PSA amplifiers (1DS or 110) are disabled in preselected sweeps using the N9039A.

The RF Preselector has two inputs:

RF Input for EMI measurements

Cal Source Input for user alignments with a designated external source

## Requirements for PSA based EMI Receiver

- The PSA needs to be upgraded to revision A.10.00 or later.
- The PSA must have Option 239, EMI Receiver personality, installed.

### Conditions Required to Meet Specifications

- The PSA, RF Preselector and Source are within their calibration cycle.
- After all the components have been at operating temperature at least 2 hours.
- The PSA has met the conditions required to meet its specifications (refer to PSA core specifications)
- A minimum of 30 minutes of warm-up time for all three components are required before an RF Preselector user alignment is initiated.
- The user alignment for RF Preselector must be run:
  - Within the last 120 hours
  - Any time the ambient temperature changes more than 3 °C

## Frequency

Specification Name	Information
<b>Frequency Specifications</b>	
Frequency Range	9 kHz to 1 GHz
Frequency Reference	See “ <a href="#">Frequency Reference</a> ” on page 23 in the core specifications.
Frequency Readout Accuracy	See “ <a href="#">Frequency Readout Accuracy</a> ” on page 24 in the core specifications.
Frequency Counter Count Accuracy	See “ <a href="#">Frequency Counter Count Accuracy</a> ” on page 24 in the core specifications.
Delta Count Accuracy	See “ <a href="#">Delta Count Accuracy</a> ” on page 24 in the core specifications.
Resolution	See “ <a href="#">Resolution</a> ” on page 24 in the core specifications.
Frequency Span	See “ <a href="#">Frequency Span</a> ” on page 25 in the core specifications.
	Bypass path for the EMI Receiver has both swept and FFT based measurements available. Preselected path has swept based measurements.
Sweep Time	See “ <a href="#">Sweep Time vs. Span</a> ” on page 358 in this section.
Sweep Trigger <sup>a</sup>	See “ <a href="#">Sweep Trigger</a> ” on page 26 in the core specifications.
Gated FFT <sup>b</sup>	See “ <a href="#">Gated FFT</a> ” on page 26 in the core specifications.
Gated Sweep <sup>c</sup>	See “ <a href="#">Gated Sweep</a> ” on page 27 in the core specifications.

- a. In bypass path the EMI receiver has all trigger types available. In preselected path the EMI receiver has all trigger types available while in zero span. In non-zero span external triggers are used to synchronize the preselector and PSA.
- b. The Gated FFT is not available in the preselected sweeps.
- c. The Gated Sweep is not available in the preselected sweeps.

Specification Name	Information
Number of Frequency Display Trace Points (buckets)	See “Number of Frequency Display Trace Points (buckets)” section of the core specifications.
Resolution Bandwidth (RBW)	See “Resolution Bandwidth (RBW)” section of the core specifications.
EMI Resolution Bandwidths <sup>a</sup>	See “EMI Resolution Bandwidths” section of the core specifications.
Analysis Bandwidth <sup>b</sup>	See “Analysis Bandwidth” section of the core specifications.
Input Mixer Level	See “Input Mixer Level” section of the core specifications.

- a. Meets all CISPR 16-1-1 (2006) and MIL-STD-461D/E resolution bandwidth standards.
- b. Not available in the preselected sweeps. In preselected path the EMI receiver uses standard IF bandwidths.

**Table 24-1 Data Points as a Function of CISPR Band**

CISPR Band	Frequency Range	CISPR RBW	Default Data Points <sup>a</sup>
Band A	9 – 150 kHz	200 Hz	706
Band B	150 kHz – 30 MHz	9 kHz	3318
Band C	30 – 300 MHz	120 kHz	2251
Band D	300 MHz – 1 GHz	120 kHz	5835
Band C/D	30 MHz – 1 GHz	120 kHz	8085
Band E <sup>b</sup>	1 – 18 GHz	1 MHz	8192

- a. Every data point captures an IF bucket.
- b. Maximum number of data points allowed by PSA

EMI Receiver Specifications: PSA and N9039A RF Preselector  
**Frequency**

Description	Specifications	Supplemental Information	
<b>Sweep Time vs. Span</b>  Band A: 9-150 kHz Band B: 150 kHz-30 MHz Band C/D: 30-1000 MHz		Auto-coupled sweep conditions, Nominal values	
		Bypass <sup>a</sup>	Preselected <sup>b</sup>
		5.775 s	5.775 s
		715.4 ms	1.055 s
158.8 ms	630.6 ms		

a. Nominally follows the PSA sweep time rules

b. Default number of sweep points based on "Data points as a function of CISPR Band" table.

---

## Amplitude

Specification Name	Information
<b>Amplitude Specifications</b>	
<b>Display Range</b>	See the “Display Range” section of the core specifications
Log Scale	
Linear Scale	
<b>Marker Readout</b>	See the “Marker Readout” section of the core specifications
Available Detectors	See the “Available Detectors” section of the core specifications
EMI Detectors	See the “EMI Detectors” section of the core specifications

EMI Receiver Specifications: PSA and N9039A RF Preselector  
Amplitude

Description	Specifications	Supplemental Information
<b>Maximum Safe Input Level</b>		Applies with or without preamp
<b>Preselected Path<sup>a</sup></b>		
Average Total Power	+30 dBm (1 W)	With RF Preselector Gain On or Off
RF Preselector attenuation $\geq 10$ dB		
Peak Pulse Power	+50 dBm (100 W)	With RF Preselector Gain On or Off
RF Preselector attenuation $\geq 10$ dB		Max. Pulse Energy = $100\text{W} \times 0.01\text{ms} = 1 \text{ mWs}$
DC volts <sup>b</sup>	$\pm 7.0$ Vdc	
<b>Bypass Path</b>		
Average Total Power	+30 dBm (1 W)	
Applies with preamp ( <i>Option IDS</i> )	+30 dBm (1 W)	
Applies with preamp ( <i>Option 110</i> )	+25 dBm	
Peak Pulse Power	+50 dBm (100 W)	
<10 ms pulse width, <1 % duty cycle, and PSA attenuation $\geq 30$ dB		
DC volts		
DC Coupled	$\pm 0.2$ Vdc	
AC Coupled (E4443A, E4445A, E4440A)	$\pm 7.0$ Vdc	

- a. The RF preselected path is protected by a limiter (30 dBm)
- b. When using the EMI Presets and conducted bands to 30 MHz, the PSA input is DC coupled. For radiated bands, above 30 MHz the PSA input is AC coupled only if for models E4440A, E4443A and E4445A. AC coupling is not available on the E4446A, E4447A and E4448A.



Description	Specification	Supplemental Information
<p><b>Overload Detection</b></p> <p>Preselected Path</p> <p>Bypass Path</p> <p>20 MHz to 26.5 GHz</p>	<p>Meets the CISPR specifications<sup>a</sup></p>	<p>See “Gain Compression” in core specifications</p>

a. CISPR 16-1-1 (2006-03)

Description	Specifications	Supplemental Information
<p><b>Measurement Range<sup>a</sup></b></p> <p>Preselected Path</p> <p>RF Preselector Attenuation Range</p> <p><b>Bypass Path</b></p>	<p>Displayed Average Noise Level to +30 dBm (137 dB<math>\mu</math>V)</p> <p>0 and 10 to 57.5 dB, in 2.5 dB steps</p>	<p>With RF Preselector Gain ON or OFF</p> <p>See “Measurement Range” in core specifications</p>

a. Power at EMI Receiver input

EMI Receiver Specifications: PSA and N9039A RF Preselector  
**Amplitude**

Description	Specifications	Supplemental Information
<p><b>Gain Compression</b></p> <p>1 dB gain compression point (pulse)</p> <p><b>Preselected Path</b></p> <p>RF Preselector attenuation = 0 dB            RF Preselector Gain = OFF</p> <p>9 kHz – 1 MHz</p> <p>1 – 20 MHz</p> <p>20 – 28 MHz</p> <p>28 – 200 MHz</p> <p>200 – 820 MHz</p> <p>820 MHz – 1 GHz</p> <p><b>Bypass Path</b></p> <p>20 MHz to 26.5 GHz</p>		<p>Peak pulse power at EMI Receiver input (nominal)</p> <p>–9 dBm</p> <p>–6 dBm</p> <p>–1 dBm</p> <p>0 dBm</p> <p>+3 dBm</p> <p>+2 dBm</p> <p>The 1 dB gain compression point (pulse) is nominally the same with 1 dB gain compression (two-tone) of core specifications</p>

Description	Specifications	Supplemental Information
<b>Displayed Average Noise Level (DANL)<sup>a b</sup></b>		
<b>Preselected Path</b>		
	DANL Contribution	
RF Preselector Gain = OFF	5 to 50 °C	
9 to 150 kHz	13.0 dB	
150 kHz to 30 MHz	8.0 dB	
30 to 300 MHz	6.0 dB	
300 MHz to 1.0 GHz	5.0 dB	
RF Preselector Gain = ON		
9 to 150 kHz		-3.0 dB (nominal)
150 kHz to 30 MHz		-3.0 dB (nominal)
30 to 300 MHz		-3.0 dB (nominal)
300 MHz to 1.0 GHz		-3.0 dB (nominal)
<b>Bypass Path</b>		
		DANL Contribution
9 to 150 kHz		0.5 dB (nominal)
150 kHz to 30 MHz		0.5 dB (nominal)
30 to 300 MHz		0.5 dB (nominal)
300 MHz to 1.0 GHz		1.0 dB (nominal)
1 to 10 GHz		2.0 dB (nominal)
10 to 23 GHz		3.0 dB (nominal)
23 to 26.5 GHz		5.5 dB (nominal)

a. Preselector Displayed Average Noise Level (DANL) is described as DANL contribution. When the RF Preselector is configured with a PSA the RF Preselector DANL contribution must be combined with the relevant PSA DANL to determine the EMI Receiver DANL. The following equation should be used to calculate the EMI Receiver DANL:

$$\text{EMI Receiver DANL} = \text{PSA DANL} + \text{RF Preselector DANL Contribution}$$

For Example: Assume the PSA is an E4440A, and the test frequency is 50 MHz.

$$\text{E4440A DANL at 50 MHz} = -154 \text{ dBm}$$

$$\text{RF Preselector DANL Contribution} = 6 \text{ dB}$$

$$\text{EMI Receiver DANL} = -154 \text{ dBm} + 6 \text{ dB}$$

$$= -148 \text{ dBm}$$

EMI Receiver Specifications: PSA and N9039A RF Preselector  
**Amplitude**

b. Verification conditions to measure DANL Contribution:

- RF Preselector Attenuation = 10 dB
- RBW = 1 kHz
- VBW = 30 Hz
- Span = 0 Hz
- Detector = Average Detector

Description	Specifications		Supplemental Information
<b>Absolute Amplitude Accuracy</b> for RF Input <sup>a b</sup>	20 to 30 °C	5 to 50 °C	
<b>Preselected Path</b>			
RF Preselector Gain = OFF			
RF Preselector Attenuation			
<b>0 dB</b>			
9 kHz to 1 GHz			±0.85 dB (nominal)
10 dB			
9 to 150 kHz	±1.20 dB	±1.55 dB	±0.50 dB (typical)
150 kHz to 30 MHz	±1.20 dB	±1.70 dB	±0.55 dB (typical)
30 to 300 MHz	±1.25 dB	±1.70 dB	±0.65 dB (typical)
300 MHz to 1 GHz	±1.40 dB	±2.00 dB	±0.75 dB (typical)
12.5 to 40 dB			
9 to 150 kHz	±1.25 dB	±1.95 dB	±0.65 dB (typical)
150 kHz to 30 MHz	±1.25 dB	±2.00 dB	±0.65 dB (typical)
30 to 300 MHz	±1.25 dB	±1.65 dB	±0.65 dB (typical)
300 MHz to 1 GHz	±1.45 dB	±2.00 dB	±0.75 dB (typical)
42.5 to 57.5 dB			
9 to 150 kHz	±1.55 dB		±0.80 dB (typical)
150 kHz to 30 MHz	±1.40 dB		±0.70 dB (typical)
30 to 300 MHz	±1.60 dB		±0.80 dB (typical)
300 MHz to 1 GHz	±1.70 dB		±0.90 dB (typical)
RF Preselector Gain = ON			
RF Preselector Attenuation			
<b>0 dB</b>			

Description	Specifications		Supplemental Information
9 kHz to 1 GHz 10 dB			±0.90 dB (nominal)
9 to 150 kHz	±1.20 dB	±1.55 dB	±0.55 dB (typical)
150 kHz to 30 MHz	±1.25 dB	±1.70 dB	±0.60 dB (typical)
30 to 300 MHz	±1.45 dB	±1.90 dB	±0.75 dB (typical)
300 MHz to 1 GHz	±1.45 dB	±2.00 dB	±0.75 dB (typical)
12.5 to 57.5 dB 9 kHz to 1 GHz			±0.90 dB (nominal)
<b>Bypass Path</b>			
PSA Attenuation			
<b>10 dB</b>			
9 kHz to 1 GHz	±1.00 dB	±1.45 dB	±0.30 dB (typical)
1 to 3 GHz			±0.60 dB (nominal)
3 to 6.6 GHz			±1.70 dB (nominal)
6.6 to 26.5 GHz			±2.90 dB (nominal)
Preamp On (1DS)			
100 kHz to 1.0 GHz			±0.45 dB (nominal)
1 to 3 GHz			±0.80 dB (nominal)
Preamp On (110) <sup>c</sup>			
10 MHz to 3.0 GHz			±0.75 dB (nominal)
3 to 6.6 GHz			±1.00 dB (nominal)
6.6 to 19 GHz			±1.80 dB (nominal)
19 to 26.5 GHz			±2.40 dB (nominal)

- a. Conditions required for absolute amplitude accuracy
  1. 5 day user alignment cycle
  2. plus or minus 3 degrees of last user alignment temperature
  3. S/N Ratio > 20 dB
- b. Source input absolute amplitude accuracy nominally equals RF input absolute amplitude accuracy
- c. For frequencies greater than 3 GHz PSA attenuation = 0 dB

EMI Receiver Specifications: PSA and N9039A RF Preselector  
**Amplitude**

Description	Specifications	Supplemental Information	
<b>RF Preselector Gain &amp; Noise Figure<sup>a</sup></b>		Gain (nominal)	Noise Figure (nominal)
RF Preselector Gain = OFF		10 dB	13 dB
RF Preselector Gain = ON		25 dB	10 dB

a. The difference from RF Preselector Gain = OFF to RF Preselector Gain = ON is 15 dB

Description	Specifications	Supplemental Information	
<b>RF Input VSWR</b> 9 kHz to 1 GHz			
<b>Preselected Path</b>			
RF Preselector Gain = OFF			
RF Preselector atten. = 0 dB	2.0:1	1.79:1 (typical)	
RF Preselector atten. ≥ 10 dB	1.2:1	1.16:1 (typical)	
RF Preselector Gain = ON			
RF Preselector atten. = 0 dB		1.70:1 (nominal)	
RF Preselector atten. ≥ 10 dB		1.17:1 (nominal)	
<b>Bypass Path</b>		Nominally follows the PSA specification	

Description	Specifications	Supplemental Information
<p><b>General Spurious Responses<sup>a</sup></b></p> <p>Preselected Path</p> <p>Mixer Level<sup>b</sup> = -10 dBm</p> <p>9 kHz to 1 GHz</p> <p>Bypass Path</p> <p><b>IF and LO Related Spurious</b></p> <p><b>Preselected Path</b></p> <p>Image Responses</p> <p>10 MHz to 1 GHz</p> <p>Multiples and Out-of-band Responses</p> <p>10 MHz to 1 GHz</p> <p>Bypass Path</p>	<p>Meets CISPR Specification<sup>c</sup></p> <p>Meets CISPR Specification<sup>c</sup></p> <p>Meets CISPR Specification<sup>c</sup></p>	<p>-77 dBc (nominal)</p> <p>Nominally matches PSA spurious specification + 3 dB</p> <p>-77 dBc (nominal)</p> <p>-77 dBc (nominal)</p> <p>Nominally matches PSA spurious specification + 3 dB</p>

a. Preselected Path, RF Preselector Attenuation = 10 dB

b. Mixer level = RF Preselector Input Level – RF Preselector Attenuation + RF Preselector Gain –10 dB

c. CISPR 16-1-1 (2006-03)

EMI Receiver Specifications: PSA and N9039A RF Preselector  
**Amplitude**

Description	Specifications	Supplemental Information
<b>Second Harmonic Distortion</b> <b>Preselected Path</b> RF Preselector Gain ON or OFF Source Frequency 7 to 500 MHz  <b>Bypass Path</b>		+60 dBm (nominal)  Nominally meets PSA specifications



Description	Specifications	Supplemental Information
<b>RF Preselector Third Order Intercept</b> a b c  Tone separation >15 kHz  <b>Preselected Path</b>  (5 to 50 °C)  RF Preselector Gain = OFF  10 to 30 MHz 30 to 300 MHz 300 MHz to 1.0 GHz  RF Preselector Gain = ON  10 to 30 MHz 30 to 300 MHz 300 MHz to 1.0 GHz  <b>Bypass Path<sup>d</sup></b>		
		+9.0 dBm (typical)
		+7.0 dBm (typical)
		+11.0 dBm (typical)
		-2.0 dBm (nominal)
		0.0 dBm (nominal)
		-2.0 dBm (nominal)
		Nominally meets PSA specifications

- RF Preselector TOI is verified with two tones, each at -15 dBm for RF Preselector Gain = OFF (-25 dBm for RF Preselector Gain = ON) at the RF Preselector input, with 0 dB RF Preselector attenuation, spaced by 100 kHz.
- The TOI is given by the input power to the preselector (in dBm) - (distortion/2) where distortion is the relative level of the distortion tones in dBc.
- The EMI Receiver TOI in the preselected path, referenced to the EMI Receiver input is given by the equation below:

$$TOI_{EMIRceiver}(dBm) = - \left( 10 \cdot \log \left[ 10^{\frac{-TOI_{PSA}}{10}} + 10^{\frac{-TOI_{RFPreselel}}{10}} \right] \right)$$

- Bypass path TOI is referenced to the EMI receiver input. PSA input attenuation is set to 0 dB.

EMI Receiver Specifications: PSA and N9039A RF Preselector  
**Amplitude**

Description	Specifications	Supplemental Information
<p><b>Residual Responses<sup>a</sup></b></p> <p><b>Preselected Path</b></p> <p>RF Preselector Gain = OFF            200 kHz to 1 GHz</p> <p>RF Preselector Gain = ON            200 kHz to 1 GHz</p> <p><b>Bypass Path</b></p> <p>200 kHz to 26.5 GHz</p>		<p>-93 dBm (nominal)</p> <p>-84 dBm (nominal)</p> <p>-97 dBm (nominal)</p>

a. EMI Receiver input terminated, RF Preselector Attenuation = 0 dB

---

## N9039A RF Preselector Specifications

Description	Specifications	Supplemental Information
Calibration Cycle	1 year	

Description	Specifications	Supplemental Information
Model and Option listings <b>RF IN / OUT</b> <i>Option BAB</i>		Type N Connector APC 3.5 Connector

EMI Receiver Specifications: PSA and N9039A RF Preselector  
**N9039A RF Preselector Specifications**

Description	Range	Specifications
<b>Pre-selection Filters</b>		<b>–6 dB bandwidth (nominal)</b>
	9 to 150 kHz	284 kHz, fixed lowpass
	150 kHz to 1 MHz	1.5 MHz, fixed bandpass
	1 to 2 MHz	2.5 MHz, fixed bandpass
	2 to 5 MHz	6.9 MHz, fixed bandpass
	5 to 8 MHz	9.0 MHz, fixed bandpass
	8 to 11 MHz	9.2 MHz, fixed bandpass
	11 to 14 MHz	8.9 MHz, fixed bandpass
	14 to 17 MHz	9.2 MHz, fixed bandpass
	17 to 20 MHz	8.7 MHz, fixed bandpass
	20 to 24 MHz	9.0 MHz, fixed bandpass
	24 to 28 MHz	8.8 MHz, fixed bandpass
	28 to 32 MHz	8.8 MHz, fixed bandpass
	28 to 55 MHz	5.1 MHz, tracking bandpass
	55 to 100 MHz	6.5 MHz, tracking bandpass
	100 to 155 MHz	10 MHz, tracking bandpass
	155 to 235 MHz	16.8 MHz, tracking bandpass
235 to 350 MHz	22.5 MHz, tracking bandpass	
350 to 470 MHz	41 MHz, tracking bandpass	
470 to 620 MHz	64 MHz, tracking bandpass	
620 to 820 MHz	49 MHz, tracking bandpass	
820 to 1 GHz	69 MHz, tracking bandpass	

Description	Specifications	Supplemental Information
<b>Inputs and Outputs</b>		
<b>Front Panel</b>		
RF IN	Type N APC 3.5	female (Standard) male (Option BAB)
RF OUT	Type N APC 3.5	female (Standard) male (Option BAB)
CAL SOURCE IN	Type N	female
USB 2.0 Ports		female
Master (2 ports) Connector	USB Type "A"	
Output Current		0.5 A (nominal)
<b>Rear Panel</b>		
EXTERNAL TRIGGER OUT	BNC	female
PULSE TRIGGER 2 OUT	BNC	female
Monitor Out		
Connector	VGA compatible, 15-pin mini D-SUB	
Format		XGA (60 Hz vertical sync rates, non-interlaced) Analog RGB
Resolution	1024 x 768	
USB 2.0 Ports		
Master (4 ports)		
Connector	USB Type "A"	female
Output Current		0.5 A (nominal)
Slave (1 port)		
Connector	USB Type "B"	female
Output Current		0.5 A (nominal)
GPIB Interface		
Connector	IEEE-488 bus connector	
GPIB Codes		SH1, AH1, T6, SR1, RL1, PP0, DC1, C1,C2, C3 and C28, DT1, L4, C0
LAN TCP/IP Interface	RJ45 Ethertwist	100BaseT

EMI Receiver Specifications: PSA and N9039A RF Preselector  
**N9039A RF Preselector Specifications**

Description	Specifications	Supplemental Information
<b>Temperature Range</b>  Operating  Storage  <b>Altitude</b>	5 to 50 °C  -40 to 70 °C  4600 meters (approx. 15,000 feet)	

Description	Specifications	Supplemental Information
<b>Environmental and Military Specifications</b>		Samples of this product have been type tested in accordance with the Agilent Environmental Test Manual and verified to be robust against the environmental stresses of Storage, Transportation and End-use; those stresses include but are not limited to temperature, humidity, shock, vibration, altitude and power line conditions. Test Methods are aligned with IEC 60068-2 and levels are similar to MIL-PRF-28800F Class 3

Description	Specification
<b>EMC</b>	Complies with European EMC Directive 2004/108/EC  IEC/EN 61326-1 or IEC/EN 61326-2-1  CISPR Pub 11 Group 1, class A  AS/NZS CISPR 11  ICES/NMB-001  This ISM devise complies with ICES-001. Cet appareil ISM est conforme a la norme NMB-001 du Canada.  The N9039A based EMI measurement receiver has been tested as fully compliant to CISPR 16-1-1 2003 and 2006 by World Cal. Inc., a well recognized independent calibration facility

Acoustic Noise Emission/Geraeuschemission <sup>a</sup>	
LpA <65 dB	LpA <60 dB
Operator position	Am Arbeitsplatz
Normal position	Normaler Betrieb
Per ISO 7779	Nach DIN 45635 t.19

- a. The Agilent N9039A meets the Agilent Quiet office/lab/test space sound pressure and sound power specification when ventilation input temperature is below +28 degrees C. It complies with German Acoustic regulations:

Acoustic noise emission Geraeuschemission

Description	Specification
<b>Safety</b>	Complies with European Low Voltage Directive 2006/95/EC — IEC/EN 61010-1 2nd Edition — Canada: CSA C22.2 No. 61010-1 — USA: UL 61010-1 2nd Edition 1

Description	Specification	Supplemental Information
<b>Power Requirements</b>		
Voltage (low range)	100/120 V	
Frequency	50/60 Hz	
Voltage (high range)	220/240 V	
Frequency	50/60 Hz	
Maximum Power Consumption	250 W	

EMI Receiver Specifications: PSA and N9039A RF Preselector  
**N9039A RF Preselector Specifications**

Description	Specifications	Supplemental Information
<b>Dimensions</b>		
Height	177 mm (7.0 in)	Without feet (add 15 mm with feet)
Width	425 mm (16.7 in)	Without side handles (add 12 mm with handles)
Length	551 mm (21.7 in)	

Description	Specifications	Supplemental Information
<b>Weight</b>		
Net		18 kg (40 lbs)
Shipping		21 kg (46 lbs)

Description	Specifications	Supplemental Information
<b>Displays</b>		
Resolution	1024 x 768	XGA
Size		213 mm (8.4 in) diagonal (nominal)



---

## **25**      **Measuring Receiver Personality**

This chapter contains specifications for the N5531S measuring receiver system using the PSA Series, Option 233, Built-in measuring receiver personality.

## Additional Definitions and Requirements

This chapter contains specifications and supplemental information for the N5531S measuring receiver system (comprised of a PSA spectrum analyzer with Option 233, a P-Series, or an EPM/EPM-P Series<sup>1</sup> power meter, and an N5532A/B sensor module).

Available for all PSA models: E4443A/45A/40A/47A/46A/48A.

The following conditions must be met for the analyzer to meet the specifications included in this chapter.

### PSA Conditions Required to Meet Specifications

- The system components are within their calibration cycle.
- RF Tuned Level using the “High Accuracy Mode”
- Fast Mode set to "Off" when performing modulation measurements.
- For center frequencies < 20 MHz, DC coupling applied.
- At least 2 hours of storage or operation at the operating temperature of 20 to 30 °C.
- The PSA has been turned on at least 30 minutes with **Auto Align On** selected or if **Auto Align Off** is selected, **Align All Now** must be run:
  - Within the last 24 hours, and
  - Any time the ambient temperature changes more than 3 °C, and
  - After the analyzer has been at operating temperature at least 2 hours.
- For analog modulation measurements, a direct connection between the PSA and the device under test (DUT) is required to achieve the best performance and meet the specifications for all test frequencies.
- The following options are required as stated in the specifications.
  - Option 123 microwave pre-selector bypass must be installed to meet TRFL specifications above 3 GHz.
  - Option 107 (Audio input 100 kΩ) is required with option 233 (Built-in measuring receiver personality) for the audio analysis.
  - Option 1DS (pre-amplifier below 3GHz) or option 110 (pre-amplifier up to 50GHz) is needed to achieve better sensitivity as indicated in the specifications guide.

---

1. For the E4416A, E4417A, E4418B, and E4419B power meters to work with the N5531S measuring receiver, a LAN/GPIB gateway is required.

## Frequency Modulation

Description				Specification	Supplemental Information
<b>Input Power Range</b>				-18 to +30 dBm	
<b>Operating Rate Range<sup>a</sup></b>					
100 kHz ≤ f <sub>c</sub> < 10 MHz				20 Hz to 10 kHz	
10 MHz ≤ f <sub>c</sub> < 50 GHz				50 Hz to 200 kHz	
<b>Peak Frequency Deviations<sup>a</sup></b>					
100 kHz < f <sub>c</sub> < 10 MHz				40 kHz maximum	Peak Deviation = IFBW/2 – Modulation Rate.  IFBW <sub>max</sub> = 5 MHz in “Auto” mode; IFBW <sub>max</sub> = 10 MHz in “Manual” mode
10 MHz < f <sub>c</sub> < 50 GHz				400 kHz maximum	
<b>FM Deviation Accuracy<sup>b</sup></b>					
Frequency Range	Modulation Rate	Peak Deviation	β <sup>c</sup>		
250 kHz to 10 MHz	20 Hz to 10 kHz	200 Hz to 40 kHz	> 0.2 > 1.2	±1.5% of reading ±1% of reading	
10 MHz to 6.6 GHz	50 Hz to 200 kHz	250 Hz to 400 kHz	> 0.2 > 0.45	±1.5% of reading ±1% of reading	
6.6 to 13.2 GHz	50 Hz to 200 kHz	250 Hz to 400 kHz	> 0.2 > 8	±2.5% of reading ±1% of reading	
13.2 to 31.15 GHz	50 Hz to 200 kHz	250 Hz to 400 kHz	> 0.2 > 16	±3.8% of reading ±1% of reading	
31.15 to 50 GHz	50 Hz to 200 kHz	250 Hz to 400 kHz	> 0.2 > 32	±8.5% of reading ±1% of reading	

- The modulation rates and the peak deviations that the system is capable of measuring are governed by the instrument’s IFBW (Information Bandwidth) setting. Their relationship is described by the equation: Peak deviation (in Hz) = IFBW/2 – modulation rate.
- When the carrier frequency f<sub>c</sub> is less than 10 MHz, to avoid the image signal that appears in the IF corresponding to the negative of the signal frequency, the f<sub>c</sub> and IFBW must be chosen to satisfy IFBW < 2 × (f<sub>c</sub> – 100 kHz).
- β is the ratio of frequency deviation to modulation rate (deviation/rate)

Measuring Receiver Personality  
**Frequency Modulation**

Description			Specification	Supplemental Information
<b>Modulation Distortion Floor</b>				See “Modulation Distortion” on page 389.
<b>AM Rejection (50 Hz to 3 kHz BW)</b>				
Frequency Range	Modulation Rates	AM Depths		
150 kHz to 3 GHz	400 Hz or 1 kHz	≤ 50%	< 10 Hz peak deviation	
3 to 6.6 GHz	400 Hz or 1 kHz	≤ 50%		< 10 Hz
6.6 to 13.2 GHz	400 Hz or 1 kHz	≤ 50%		< 20 Hz
13.2 to 26.5 GHz	400 Hz or 1 kHz	≤ 50%		< 40 Hz
26.5 to 50 GHz	400 Hz or 1 kHz	≤ 50%		< 75 Hz

Description	Specification	Supplemental Information
<p><b>Residual FM (50 Hz to 3 kHz BW)<sup>a</sup></b>            RF Frequency</p> <p>100 kHz to 6.6 GHz</p> <p>6.6 to 13.2 GHz</p> <p>13.2 to 31.15 GHz</p> <p>31.15 to 50 GHz</p> <p><b>Detectors</b></p> <p><b>Auto Carrier Frequency Triggering<sup>b</sup></b></p>	<p>&lt; 1.5 Hz (rms)</p> <p>&lt; 3 Hz (rms)</p> <p>&lt; 6 Hz (rms)</p> <p>&lt; 12 Hz (rms)</p> <p>Free run, Video, RF Burst, External (Front or Rear)</p>	<p>Available: +peak, -peak, ±peak/2, peak hold, rms</p>

- a. Follow this procedure to verify this specification:
- Input a clean CW signal (0 dB) from a signal source to the measuring receiver. (The recommended source is Agilent E8257D with option UNR or UNX.)
  - Lock the signal source 10 MHz reference to the PSA 10 MHz reference output.
  - Select "FM Deviation" on the measuring receiver.
  - Manually tune the frequency to the input signal.
  - Set the PSA parameters as follows, (1) IF BW = 6 kHz, (2) Detector Type = RMS, (3) High Pass Filter = 50 Hz, (4) Low Pass Filter = 3 kHz.
- b. PSA firmware revision ≥ A.11.08, or Option 23A.

## Amplitude Modulation

Description	Specification	Supplemental Information
<b>Input Power Range</b>	-18 to +30 dBm	
<b>Operating Rate Range<sup>a</sup></b>		
100 kHz ≤ $f_c$ < 10 MHz	20 Hz to 10 kHz	
10 MHz ≤ $f_c$ < 50 GHz	50 Hz to 100 kHz	

- a. When the carrier frequency  $f_c$  is less than 10 MHz, to avoid the image signal that appears in the IF corresponding to the negative of the signal frequency, the  $f_c$  and IFBW must be chosen to satisfy  $\text{IFBW} < 2 \times (f_c - 100 \text{ kHz})$ .

Description	Specification	Supplemental Information
<b>Depth Range</b>	5 to 99%	Capable of measuring AM depth range of 0 to 99%.
<b>AM Depth Accuracy<sup>a</sup></b>		
Frequency Range	Modulation Rate	Depths
100 kHz to 10 MHz	50 Hz to 10 kHz	5 to 99%
		±0.75% of reading
10 MHz to 3 GHz	50 Hz to 100 kHz	20 to 99%
		±0.5% of reading
		5 to 20%
		±2.5% of reading
3 to 26.5 GHz	50 Hz to 100 kHz	20 to 99%
		±1.5% of reading
		5 to 20%
		±4.5% of reading
26.5 to 31.15 GHz	50 Hz to 100 kHz	20 to 99%
		±1.9% of reading
		5 to 20%
		±6.8% of reading
31.15 to 50 GHz	50 Hz to 100 kHz	20 to 99%
		±6% of reading
		5 to 20%
		±26% of reading

- a. For peak measurement only: AM accuracy may be affected by distortion generated by the measuring receiver. In the worst case this distortion can decrease accuracy by 0.1% of reading for each 0.1% of distortion.

Description			Specification	Supplemental Information
<b>Flatness<sup>a</sup></b>				
Frequency Range	Modulation Rate	Depths		
10 MHz to 3 GHz	90 Hz to 10 kHz	5 to 99%	±0.30% of reading	
3 to 26.5 GHz	90 Hz to 10 kHz	5 to 99%	±0.40% of reading	
26.5 to 50 GHz	90 Hz to 10 kHz	5 to 99%	±0.60% of reading	
<b>Modulation Distortion Floor</b>				See <a href="#">“Modulation Distortion” on page 389.</a>

- a. Flatness is the relative variation in indicated AM depth versus rate for a constant carrier frequency and depth.

Measuring Receiver Personality  
Amplitude Modulation

Description			Specification	Supplemental Information
<b>FM Rejection (50 Hz to 3 kHz BW)</b>				
Frequency Range	Modulation Rate	Peak FM Deviations		
250 kHz to 10 MHz	400 Hz or 1 kHz	< 5 kHz	< 0.14% AM depth	
10 MHz to 50.0 GHz	400 Hz or 1 kHz	< 50 kHz	< 0.36% AM depth	
<b>Residual AM (50 Hz to 3 kHz BW)</b>			< 0.01% (rms) <sup>a b</sup>	
<b>Detectors</b>				Available: +peak, -peak, ±peak/2, peak hold, rms
<b>Auto Carrier Frequency Triggering<sup>c</sup></b>			Free run, Video, RF Burst, External (Front or Rear)	

- a. Preamp must be on to meet this specification for frequency range of 26.5 to 50 GHz.
- b. Follow this procedure to verify this specification:
  - Input a clean CW signal (0 dBm) from a signal source to the measuring receiver. (The recommended source is Agilent E8257D with option UNR or UNX.)
  - Lock the signal source 10 MHz reference to the PSA 10 MHz reference output.
  - Select “AM Depth” on the measuring receiver.
  - Manually tune the frequency to the input signal.
  - Set the PSA parameters as follows: (1) IF BW = 6 kHz, (2) Detector type = RMS, (3) High Pass Filter = 50 Hz, (4) Low Pass Filter = 3 kHz, (5) Set “RF Input Ranging” to “Man”, and decrease the input attenuation at 2 dB/step until “SigHi” message appears. Then back off 2 dB for the “SigHi” message to disappear.
 Option 123 (Preselector bypass) must be installed and preselector is set to OFF to meet specifications above 3 GHz.
- c. PSA firmware revision ≥ A.11.08, or Option 23A.



## Phase Modulation

Description	Specification	Supplemental Information
<b>Input Power Range</b>	-18 to +30 dBm	
<b>Operating Rate Range</b> $100 \text{ kHz} \leq f_c < 50 \text{ GHz}$	200 Hz to 20 kHz	
<b>Maximum Peak Phase Deviation</b> $f_c < 10 \text{ MHz}$	450 radians <sup>a</sup>	
$f_c \geq 10 \text{ MHz}$	12,499 radians <sup>b</sup> 24,999 radians <sup>b</sup>	In "Auto" mode In "Manual" mode

- a. When the carrier frequency  $f_c$  is less than 10 MHz, to avoid the image signal that appears in the IF corresponding to the negative of the signal frequency, the  $f_c$  and IFBW must be chosen to satisfy  $\text{IFBW} < 2 \times (f_c - 100 \text{ kHz})$ . The specification of 450 radians applies for  $f_c = 200 \text{ kHz}$ ,  $\text{IFBW} = 200 \text{ kHz}$ , and a modulation rate of 200 Hz. The specification for maximum peak phase deviation will linearly improve as the allowed IFBW increase. As  $f_c$  increases, the IFBW can increase up to the maximum allowed IFBW in "Auto" or "Manual" modes.
- b. When the carrier frequency ( $f_c$ ) is equal to or greater than 10 MHz, the maximum peak deviation that the instrument is capable of measuring depends on the IFBW setting and the modulation rate of the signal-under-test. The relationship is described by the equation:

$$\text{Max peak deviation (in radians)} = [\text{IFBW}/(2 \times \text{modulation rate in Hz})] - 1.$$

The maximum IFBW used in "Auto" mode is 5 MHz, therefore, Max peak deviation (in radians) =  $(2.5 \times 10^6 / \text{modulation rate in Hz}) - 1$ . In "Manual" mode, the maximum IFBW can be set to 10 MHz, hence, Max peak deviation (in radians) =  $(5 \times 10^6 / \text{modulation rate in Hz}) - 1$ .

Measuring Receiver Personality  
Phase Modulation

Description		Specification	Supplemental Information
<b>ΦM Accuracy</b>			
Frequency range	Deviations		
100 kHz to 6.6 GHz	> 0.7 rad	±1% of reading	
	> 0.3 rad	±3% of reading	
6.6 to 13.2 GHz	> 2.0 rad	±1% of reading	
	> 0.6 rad	±3% of reading	
13.2 to 26.5 GHz	> 4.0 rad	±1% of reading	
	> 1.2 rad	±3% of reading	
26.5 to 31.5 GHz	> 4.0 rad	±1% of reading	
	> 1.3 rad	±3% of reading	
31.5 to 50 GHz	> 8.0 rad	±1% of reading	
	> 2.4 rad	±3% of reading	
<b>Modulation Distortion Floor</b>			See “Modulation Distortion” on page 389.

Description	Specification	Supplemental Information
<b>AM Rejection (50 Hz to 3 kHz BW)</b>		
For 50% AM at 1 kHz rate	< 0.03 rad (peak)	
<b>Residual PM (50 Hz to 3 kHz BW)<sup>a</sup></b>		
Frequency range		
100 kHz to 6.6 GHz	< 0.0017 rad (rms)	
6.6 to 13.2 GHz	< 0.0033 rad (rms)	
13.2 to 31.15 GHz	< 0.0066 rad (rms)	
31.15 to 50 GHz	< 0.0130 rad (rms)	
<b>Detectors</b>		Available: +peak, -peak, ±peak/2, peak hold, rms
<b>Auto Carrier Frequency Triggering<sup>b</sup></b>	Free run, Video, RF Burst, External (Front or Rear)	

- a. Follow this procedure to verify this specification:
  - Input a clean CW signal (0 dB) from a signal source to the measuring receiver. (The recommended source is Agilent E8257D with option UNR or UNX.)
  - Lock the signal source 10 MHz reference to the PSA 10 MHz reference output.
  - Select "PM Deviation" on the measuring receiver.
  - Manually tune the frequency to the input signal.
  - Set the PSA parameters as follows, (1) IF BW = 6 kHz, (2) Detector Type = RMS, (3) High Pass Filter = 50 Hz, (4) Low Pass Filter = 3 kHz.
- b. PSA firmware revision ≥ A.11.08, or Option 23A.

## Modulation Rate<sup>1</sup>

Description	Specification	Supplemental Information
<b>Frequency Range</b> (for demodulated signals)		
<b>AM</b>		
100 kHz ≤ f <sub>c</sub> < 10 MHz	20 Hz to 10 kHz	
10 MHz ≤ f <sub>c</sub> < 50 GHz	20 Hz to 100 kHz	
<b>FM</b>		
100 kHz ≤ f <sub>c</sub> < 10 MHz	20 Hz to 10 kHz	
10 MHz ≤ f <sub>c</sub> < 50 GHz	20 Hz to 200 kHz	
<b>ΦM</b>		
100 kHz ≤ f <sub>c</sub> < 10 MHz	20 Hz to 10 kHz	
10 MHz ≤ f <sub>c</sub> < 50 GHz	20 Hz to 200 kHz	
<b>Modulation Rate Accuracy</b>		
Modulation (peak)		
<b>AM<sup>a</sup></b>		
Depth ≥ 20%, Rate ≤ 100 kHz	±(0.06 Hz + Modulation Rate × Internal Reference Accuracy) <sup>b</sup>	
β <sup>c</sup> ≥ 0.01, Rate ≤ 200 kHz	±(0.06 Hz + Modulation Rate × Internal Reference Accuracy) <sup>b</sup>	
β <sup>c</sup> ≥ 0.01, Rate ≤ 20 kHz	±(0.06 Hz + Modulation Rate × Internal Reference Accuracy) <sup>b</sup>	
<b>Displayed Resolution</b>	1 MHz	
<b>Measurement Rate</b>		2 readings/second

- Follow this procedure to verify this specification: Set an input signal at -10 dBm with 50% AM. Set the PSA as follows: (1) Auto Input Range, (2) Auto IF BW, (3) LP to be greater than the modulation rate, (4) HP=300 Hz or less than the modulation rate, (5) Average = 5 Repeat.
- Refer to the [Frequency Reference](#) section in the PSA base specifications.
- β is the ratio of frequency deviation to modulation rate (deviation/rate).

1. With 20 Hz high pass filter

## Modulation Distortion<sup>1</sup>

Description	Specification	Supplemental Information
<b>Modulation Rate</b>	200 Hz to 300 kHz	Using 50 Hz HP filter
<b>Display Range</b>	0.01% to 100% (-80 to 0 dB)	
<b>Displayed Resolution</b>	0.01% (0.01 dB)	
<b>Accuracy</b>	±1 dB of reading	
<b>Sensitivity</b> Modulation		
		See " <a href="#">Residual Noise and Distortion</a> " below for minimum modulation levels.

Description			Specification	Supplemental Information
<b>Residual Noise and Distortion</b>				
<b>AM</b>				
Frequency Range	Modulation Rate	Depths		HP = 50 Hz, LP = 3 kHz
0.1 to 10 MHz	20 Hz to 1 kHz	> 1 %	< 0.8 %	
		> 3 %	< 0.3 %	
10 MHz to 26.5 GHz	20 Hz to 1 kHz	> 1 %	< 1.0 %	
		> 3 %	< 0.4 %	
26.5 to 50 GHz	20 Hz to 1 kHz	> 1 %	< 6.2 %	
		> 3 %	< 2.0 %	
		> 5 %	< 1.5 %	

1. The PSA-based measuring receiver measures distortion plus noise as per the standard method of distortion analyzers (accepted by the Institute of High Fidelity and others, refer to "Standard Methods of Measurement For Audio Amplifiers", The Institute of High Fidelity, Inc., New York (1978), p. 9). The distortion analyzer method is simple and adequate for most situations. When using this method, it is important to understand that the measurement result is not "total harmonic distortion" except under the condition that the distortion is not too excessive but that it does predominate over any other signal impurities.

Measuring Receiver Personality  
**Modulation Distortion**

Description			Specification	Supplemental Information
$\Phi M$				PM
Frequency Range	Modulation Rate	Deviation (rad)		
1 MHz to 6.6 GHz	20 to 500 Hz	> 0.8	< 0.3%	HP = 300 Hz, LP = 3 kHz
		$\geq 2.5$	< 0.1%	
	500 Hz to 1 kHz	> 0.4	< 0.3%	
		$\geq 1.0$ rad	< 0.1%	
6.6 to 13.2 GHz	20 to 500 Hz	> 1.8	< 0.3%	
		$\geq 5.5$	< 0.1%	
	500 Hz to 1 kHz	> 0.8	< 0.3%	
		$\geq 2.5$	< 0.1%	
13.2 to 31.15 GHz	20 to 500 Hz	> 3.5	< 0.3%	
		$\geq 10.0$	< 0.1%	
	500 Hz to 1 kHz	> 1.2	< 0.3%	
		$\geq 4$	< 0.1%	
31.15 to 50 GHz	20 to 500 Hz	> 7.5	< 0.3%	
		$\geq 19$	< 0.1%	
	500 Hz to 1 kHz	> 3.0	< 0.3%	
		$\geq 8.0$	< 0.1%	

Description			Specification	Supplemental Information
<b>FM</b>				
Frequency Range	Modulation Rate	Deviation		
1 MHz to 6.6 GHz	20 Hz to 1 kHz	500 Hz to 2.0 kHz	< 0.3%	HP = 300 Hz, LP = 3 kHz
		≥ 2.0 kHz	< 0.1%	
6.6 to 13.2 GHz	20 Hz to 1 kHz	> 2.3 kHz	< 0.3%	
		≥ 4.5 kHz	< 0.1%	
13.2 to 31.15 GHz	20 Hz to 1 kHz	> 2.7 kHz	< 0.3%	
		≥ 6.0 kHz	< 0.1%	
31.15 to 50 GHz	20 Hz to 1 kHz	> 4.0 kHz	< 0.3%	
		≥ 12.0 kHz	< 0.1%	

---

## Modulation SINAD

Description	Specification	Supplemental Information
<b>Modulation Rate</b>	200 Hz to 300 kHz	Using 50 Hz HP filter
<b>Display Range</b>	0.00 to 80 dB	
<b>Displayed Resolution</b>	0.01 dB	
<b>Accuracy<sup>a</sup></b>	±1 dB of reading	

- a. Measured distortion must be greater than 3% for the accuracy specification to apply. For distortions less than 3%, the noise floor of the analyzer will begin to affect the accuracy of the measurement.



Description			Specification	Supplemental Information
<b>Residual Noise and Distortion</b>				
<b>AM</b>				
Frequency Range	Modulation Rate	Depths		
0.1 to 10 MHz	20 Hz to 1 kHz	> 1 %	41.03 dB	HP = 50 Hz, LP = 3 kHz
		> 3 %	50.45 dB	
10 MHz to 26.5 GHz	20 Hz to 1 kHz	> 1 %	40.00 dB	
		> 3 %	47.95 dB	
26.5 to 50 GHz	20 Hz to 1 kHz	> 1 %	24.15 dB	
		> 3 %	33.97 dB	
		> 5 %	36.47 dB	
<b>ΦM</b>				
Frequency Range	Modulation Rate	Deviation (rad)		
1 MHz to 6.6 GHz	20 to 500 Hz	> 0.8	50.46 dB	HP = 300 Hz, LP = 3 kHz
		≥ 2.5	60.00 dB	
	500 Hz to 1 kHz	> 0.4	50.46 dB	
		≥ 1.0	60.00 dB	
6.6 to 13.2 GHz	20 to 500 Hz	> 1.8	50.46 dB	
		≥ 5.5	60.00 dB	
	500 Hz to 1 kHz	> 0.8	50.46 dB	
		≥ 2.5	60.00 dB	
13.2 to 31.15 GHz	20 to 500 Hz	> 3.5	50.46 dB	
		≥ 10.0	60.00 dB	
	500 Hz to 1 kHz	> 1.2	50.46 dB	
		≥ 4.0	60.00 dB	
31.15 to 50 GHz	20 to 500 Hz	> 7.5	50.46 dB	
		≥ 19.0	60.00 dB	
	500 Hz to 1 kHz	> 3.0	50.46 dB	
		≥ 8.0	60.00 dB	

Measuring Receiver Personality  
**Modulation SINAD**

Description			Specification	Supplemental Information
<b>FM</b>				
Frequency Range	Modulation Rate	Deviation		
1 MHz to 6.6 GHz	20 Hz to 1 kHz	500 Hz to 2.0 kHz	50.46 dB	HP = 300 Hz, LP = 3 kHz
		≥ 2.0 kHz	60.00 dB	
6.6 to 13.2 GHz	20 Hz to 1 kHz	> 2.3 kHz	50.46 dB	
		≥ 4.5 kHz	60.00 dB	
13.2 to 31.15 GHz	20 Hz to 1 kHz	> 2.7 kHz	50.46 dB	
		≥ 6.0 kHz	60.00 dB	
31.15 to 50 GHz	20 Hz to 1 kHz	> 4.0 kHz	50.46 dB	
		≥ 12.0 kHz	60.00 dB	

## Modulation Filters

Description	Specification	Supplemental Information
<b>Filter Flatness</b>		
50 Hz High-Pass Filter	< ±1% at rates > 50 Hz	
300 Hz High-Pass Filter	< ±1% at rates > 300 Hz	
400 Hz High-Pass Filter <sup>a</sup>	< ±1% at rates > 400 Hz	
3 kHz Low-Pass Filter	< ±1% at rates < 3,030 Hz	
15 kHz Low-Pass Filter	< ±1% at rates < 15,030 Hz	
30 kHz Low-Pass Filter	< ±1% at rates < 30,000 Hz	
80 kHz Low-Pass Filter <sup>a</sup>	< ±1% at rates < 80,000 Hz	
300 kHz Low-Pass Filter	< ±1% at rates < 300,000 Hz	
<b>De-Emphasis Filters</b>	25 ms, 50ms, 75 ms, and 750 ms	De-emphasis filters are single-pole, low-pass filters with nominal -3 dB frequencies of: 6,366 Hz for 25 μs, 3,183 Hz for 50 μs, 2,122 Hz for 75 μs, and 212 Hz for 750 μs.
<b>Deviation from Ideal De-Emphasis Filter</b>	< 0.4 dB, or < 3°	Applicable to 25 μs, 50 μs, and 75 μs filters. With 3 kHz Low-Pass filter and IFBW Mode set to “minimal”.

a. PSA firmware revision ≥ A.11.08, or Option 23B.

## RF Frequency Counter

Description	Specification	Supplemental Information
<b>Range<sup>a</sup></b>	100 kHz to 50 GHz	In “Auto” mode  Frequency and Frequency Error (manual tuning)  Using manual ranging and changing RBW settings, sensitivity can be increased to approximately -100 dBm.
<b>Sensitivity<sup>b</sup></b>		
100 kHz $\leq f_c <$ 3.0 GHz	0.4 mV <sub>rms</sub> (-55 dBm)	
3.0 GHz $\leq f_c <$ 26.5 GHz	1.3 mV <sub>rms</sub> (-45 dBm)	
26.5 GHz $\leq f_c <$ 50 GHz	4.0 mV <sub>rms</sub> (-35 dBm)	
<b>Maximum Resolution</b>	0.001 Hz	
<b>Accuracy</b>	+ (readout freq. $\times$ freq. ref. accy +0.100 Hz)	
<b>Modes</b>		
<b>Sensitivity in Manual Tuning Mode</b>		

- a. When the N5532A/B Sensor module is used for the measurement, the frequency range may be limited by the sensor module’s maximum frequency.  
b. Instrument condition: RBW  $\leq$  1 kHz

## Audio Input<sup>1</sup>

Description	Specification	Supplemental Information
<b>Frequency Range</b>	20 Hz to 250 kHz	
<b>Input Impedance</b>		100 kΩ (nominal)
<b>Maximum Safe Input Level</b>	7 Vrms, or 20 Vdc	

## Audio Frequency Counter<sup>1</sup>

Description	Specification	Supplemental Information
<b>Frequency Range</b>	20 Hz to 250 kHz	
<b>Accuracy<sup>a</sup></b>		With HPF set to minimum setting of < 20 Hz
f < 1 kHz	$\pm(0.02 \text{ Hz} + f \times \text{Internal Reference Accuracy})^b$	
f ≥ 1 kHz	$\pm 3$ counts of the first 6 significant digits $\pm f \times (\text{Internal Reference Accuracy})^b$	
<b>Resolution</b>	0.01 Hz (8 digits)	
<b>Sensitivity</b>	≤5 mV	

- a. Follow this procedure to verify this specification: Set an input audio signal at 100 mV. Set the PSA as follows: (1) Auto Level, (2) Auto IF BW, (3) LP is greater than the audio frequency, (4) HP=300 Hz or less than the audio frequency, (5) Average = 5 Repeat.
- b. Refer to the [Frequency Reference](#) section in the PSA base specifications.

1. PSA Option 107 is required.

### Audio AC (RMS) Level <sup>1</sup>

Description	Specification	Supplemental Information
<b>Frequency Range</b>	20 Hz to 250 kHz	
<b>Measurement Level Range</b>	100 mV rms to 3V rms	
<b>Accuracy</b>	1% of reading	
<b>Detector Mode</b>		RMS

### Audio Distortion <sup>1</sup>

Description	Specification	Supplemental Information
<b>Display Range (20 Hz to 250 kHz BW)</b>	0.01% to 100% (-80 to 0 dB)	
<b>Accuracy (20 Hz to 250 kHz)</b>	±1 dB of reading	
<b>Residual Noise and Distortion</b>	< 0.3% (-50.4 dB)	
Total Noise		-73.2 dB characteristic performance
Total Distortion		-74.8 dB characteristic performance

### Audio SINAD <sup>1</sup>

Description	Specification	Supplemental Information
<b>Display Range (20 Hz to 250 kHz BW)</b>	0.00 to 80 dB	
<b>Display Resolution</b>	0.01 dB	
<b>Accuracy</b>		
20 Hz to 20 kHz	± 1 dB of reading	
20k Hz to 250 kHz	± 2 dB of reading	
<b>Residual Noise and Distortion</b>	50.4 dB (< 0.3%)	
Total Noise		73.2 dB characteristic performance
Total Distortion		74.8 dB characteristic performance

1. PSA Option 107 is required.

## Audio Filters<sup>1</sup>

Description	Specification	Supplemental Information
<b>Filter Flatness</b>		
50 Hz High-Pass Filter	< ±1 % at rates > 50 Hz	
300 Hz High-Pass Filter	< ±1 % at rates > 300 Hz	
400 Hz High-Pass Filter <sup>a</sup>	< ±1 % at rates > 400 Hz	
3 kHz Low-Pass Filter	< ±1 % at rates < 3,030 Hz	
15 kHz Low-Pass Filter	< ±1 % at rates < 15,030 Hz	
30 kHz Low-Pass Filter <sup>a</sup>	< ±1 % at rates < 30,000 Hz	
80 kHz Low-Pass Filter <sup>a</sup>	< ±1 % at rates < 80,000 Hz	
> 100 kHz Low-Pass Filter	< ±1 % at rates < 100 k Hz	
CCITT Weighting Filter <sup>a</sup>	CCITT Recommendation P53	
Deviation from the Ideal CCITT filter Response	±0.2 dB at 800 Hz ±1.0 dB, 300 Hz to 3 kHz ±2.0 dB, 50 to 300 Hz and 3 to 3.5 kHz ±3.0 dB, 3.5 to 5 kHz	
<b>De-Emphasis Filters</b>	25 μs, 50 μs, 75 μs, and 750 μs	De-emphasis filters are single-pole, low-pass filters with nominal –3 dB frequencies of: 6,366 Hz for 25 μs, 3,183 Hz for 50 μs, 2,122 Hz for 75 μs, and 212 Hz for 750 μs.
<b>Deviation from Ideal De-Emphasis Filter</b>	< 0.4 dB, or < 3°	Applicable to 25 μs, 50 μs, and 75 μs filters. With 3 kHz Low-Pass filter and IFBW Mode set to “minimal”.

a. PSA firmware revision ≥ A.11.08, or Option 23B.

1. PSA Option 107 is required.

## RF Power<sup>1 2</sup>

The Agilent N5531S measuring receiver system with the N5532A/B sensor modules performs RF power measurements from  $-10$  dBm ( $100 \mu\text{W}$ ) to  $+30$  dBm ( $1 \text{ W}$ ). The N5531S must be used with Agilent P-Series power meters (N1911A, N1912A), or EPM Series power meters (N1913A, N1914A). Alternatively, Agilent power meters E4416A, E4417A, E4418B, or E4419B can also be used with a LAN/GPIB gateway connecting the power meter to the PSA.

PSA Firmware Version  $\geq$ A.11.13 is required when using the N5532B power sensor.

PSA Firmware Version  $\geq$ A.11.21 is required when using the N1913A/N1914A power meters.

Description	Specification				Supplemental Information			
<b>RF Power Accuracy (dB)</b>					<b>Typicals</b>			
<b>Power Meter Range 1</b>	<b>Sensor module options</b>				<b>Sensor module options</b>			
+20 to +30 dBm	#504	#518	#526	#550	#504	#518	#526	#550
$100 \text{ kHz} \leq f_c \leq 10 \text{ MHz}$	$\pm 0.356$	–	–	–	$\pm 0.182$	–	–	–
$10 \text{ MHz} < f_c \leq 30 \text{ MHz}$	$\pm 0.356$	$\pm 0.361$	–	–	$\pm 0.182$	$\pm 0.185$	–	–
$30 \text{ MHz} < f_c \leq 2 \text{ GHz}$	$\pm 0.356$	$\pm 0.361$	$\pm 0.361$	$\pm 0.361$	$\pm 0.182$	$\pm 0.185$	$\pm 0.185$	$\pm 0.185$
$2 \text{ GHz} < f_c \leq 4.2 \text{ GHz}$	$\pm 0.356$	$\pm 0.392$	$\pm 0.422$	$\pm 0.367$	$\pm 0.182$	$\pm 0.201$	$\pm 0.217$	$\pm 0.188$
$4.2 \text{ GHz} < f_c \leq 18 \text{ GHz}$	–	$\pm 0.400$	$\pm 0.422$	$\pm 0.367$	–	$\pm 0.205$	$\pm 0.217$	$\pm 0.188$
$18 \text{ GHz} < f_c \leq 26.5 \text{ GHz}$	–	–	$\pm 0.480$	$\pm 0.387$	–	–	$\pm 0.247$	$\pm 0.199$
$26.5 \text{ GHz} < f_c \leq 50 \text{ GHz}$	–	–	–	$\pm 0.420$	–	–	–	$\pm 0.216$

1. For latest specification updates refer to N1911A/N1912A, N1913A/N1914A, E4416A/17A and E4418B/19B power meter User's Guides.
2. The N5531S RF Power Accuracy is derived from the Agilent power meter accuracy. The parameters listed in this section are components used to calculate the RF Power Accuracy. Application Note 1449-3 (P/N 5988-9215EN) does an excellent job of explaining how the components are combined to derive an overall accuracy number. The resulting calculation yields  $\pm 0.190$  to  $\pm 0.297$  dB when measuring a  $+10$  dBm signal and ignoring DUT mismatch. Assuming 1.5:1 DUT SWR, the calculation would return a typical accuracy of  $\pm 0.213$  to  $\pm 0.387$  dB (depending on the frequency range and power under test). Absolute and relative accuracy specifications do not include mismatch uncertainty.



Description	Specification				Supplemental Information			
<b>Power Meter Range 2</b>	<b>Sensor module options</b>				<b>Typicals</b>			
0 to < +20 dBm	#504	#518	#526	#550	#504	#518	#526	#550
100 kHz ≤ f <sub>c</sub> ≤ 10 MHz	±0.190	–	–	–	±0.097	–	–	–
10 MHz < f <sub>c</sub> ≤ 30 MHz	±0.190	±0.200	–	–	±0.097	±0.101	–	–
30 MHz < f <sub>c</sub> ≤ 2 GHz	±0.190	±0.200	±0.200	±0.200	±0.097	±0.101	±0.101	±0.101
2 GHz < f <sub>c</sub> ≤ 4.2 GHz	±0.190	±0.255	±0.301	±0.212	±0.097	±0.130	±0.154	±0.108
4.2 GHz < f <sub>c</sub> ≤ 18 GHz	–	±0.267	±0.301	±0.212	–	±0.136	±0.154	±0.108
18 GHz < f <sub>c</sub> ≤ 26.5 GHz	–	–	±0.380	±0.247	–	–	±0.195	±0.126
26.5 GHz < f <sub>c</sub> ≤ 50 GHz	–	–	–	±0.297	–	–	–	±0.152
<b>Power Meter Range 3</b>	<b>Sensor module options</b>				<b>Sensor module options</b>			
–5 to < 0 dBm	#504	#518	#526	#550	#504	#518	#526	#550
100 kHz ≤ f <sub>c</sub> ≤ 10 MHz	±0.207	–	–	–	±0.105	–	–	–
10 MHz < f <sub>c</sub> ≤ 30 MHz	±0.207	±0.216	–	–	±0.105	±0.110	–	–
30 MHz < f <sub>c</sub> ≤ 2 GHz	±0.207	±0.216	±0.216	±0.216	±0.105	±0.110	±0.110	±0.110
2 GHz < f <sub>c</sub> ≤ 4.2 GHz	±0.207	±0.268	±0.311	±0.227	±0.105	±0.136	±0.159	±0.116
4.2 GHz < f <sub>c</sub> ≤ 18 GHz	–	±0.279	±0.311	±0.227	–	±0.142	±0.159	±0.116
18 GHz < f <sub>c</sub> ≤ 26.5 GHz	–	–	±0.388	±0.241	–	–	±0.199	±0.123
26.5 GHz < f <sub>c</sub> ≤ 50 GHz	–	–	–	±0.333	–	–	–	±0.170
<b>Power Meter Range 4</b>	<b>Sensor module options</b>				<b>Sensor module options</b>			
–10 to < –5 dBm	#504	#518	#526	#550	#504	#518	#526	#550
100 kHz ≤ f <sub>c</sub> ≤ 10 MHz	±0.421	–	–	–	±0.216	–	–	–
10 MHz < f <sub>c</sub> ≤ 30 MHz	±0.421	±0.425	–	–	±0.216	±0.219	–	–
30 MHz < f <sub>c</sub> ≤ 2 GHz	±0.421	±0.425	±0.425	±0.425	±0.216	±0.219	±0.219	±0.219
2 GHz < f <sub>c</sub> ≤ 4.2 GHz	±0.421	±0.452	±0.477	±0.431	±0.216	±0.233	±0.246	±0.221
4.2 GHz < f <sub>c</sub> ≤ 18 GHz	–	±0.458	±0.477	±0.431	–	±0.236	±0.246	±0.221
18 GHz < f <sub>c</sub> ≤ 26.5 GHz	–	–	±0.528	±0.438	–	–	±0.273	±0.225
26.5 GHz < f <sub>c</sub> ≤ 50 GHz	–	–	–	±0.491	–	–	–	±0.253

Measuring Receiver Personality  
RF Power

Description	Specification	Supplemental Information
<b>RF Power Resolution</b>		
Display resolution	0.001 dB	

Description	Specification	Supplemental Information
<b>Instrumentation Accuracy</b>		
Logarithmic	$\pm 0.02$ dB	
Linear	$\pm 0.5\%$	
<b>Input SWR</b>		
<b>N5532A/B Option 504</b>		
100 kHz to 2 GHz	$< 1.10:1$ ( $\rho = 0.048$ )	
2 GHz to 4.2 GHz	$< 1.28:1$ ( $\rho = 0.123$ )	
<b>N5532A/B Option 518</b>		
10 MHz to 2 GHz	$< 1.10:1$ ( $\rho = 0.048$ )	
2 GHz to 18 GHz	$< 1.28:1$ ( $\rho = 0.123$ )	
<b>N5532A/B Option 526</b>		
30 MHz to 2 GHz	$< 1.10:1$ ( $\rho = 0.048$ )	
2 GHz to 18 GHz	$< 1.28:1$ ( $\rho = 0.123$ )	
18 GHz to 26.5 GHz	$< 1.40:1$ ( $\rho = 0.167$ )	
<b>N5532A/B Option 550</b>		
30 MHz to 2 GHz	$< 1.10:1$ ( $\rho = 0.048$ )	
2 GHz to 18 GHz	$< 1.28:1$ ( $\rho = 0.123$ )	
18 GHz to 26.5 GHz	$< 1.40:1$ ( $\rho = 0.167$ )	
26.5 GHz to 33 GHz	$< 1.55:1$ ( $\rho = 0.216$ )	
33 GHz to 40 GHz	$< 1.70:1$ ( $\rho = 0.259$ )	
40 GHz to 50 GHz	$< 1.75:1$ ( $\rho = 0.272$ )	

Description	Specification	Supplemental Information
<b>Zero Set and Measurement Noise<sup>a</sup></b> <b>N5532A/B Options 504, 518, 526 and 550</b>	±680 nW	
<b>Zero Drift of Sensors</b> <b>N5532A/B Options 504, 518, 526 and 550</b>	<±100 nW	(1 hour, at constant temperature after 24 hour warm-up)
<b>RF Power Ranges of N5531S with N5532A/B Sensor Modules</b>	-20 dBm (10 μW) to +30 dBm (1 W)	One range for power sensors
<b>Response Time (0 to 99% of reading)</b>		150 ms × number of averages (nominal)
<b>Displayed Units</b>	Watts, dBm, or Volts	

- a. Since Zero Set and Measurement Noise cannot be separated, the two components are combined as one error term.

**Power Reference (P-Series, EPM and EPM-P Series Specifications)**

Description	Specification	Supplemental Information
<b>Power Output</b>		Power output is traceable to the U.S. National Institute of Standards and Technology (NIST) and National Physical Laboratories (NPL), UK.
N1911A/N1912A	1.00 mW (0.0 dBm). Factory set to $\pm 0.4\%$	
N1913A/N1914A	1.00 mW (0.0 dBm). Factory set to $\pm 0.4\%$	
E4416A/E4417A	1.00 mW (0.0 dBm). Factory set to $\pm 0.4\%$	
E4418B/E4419B	1.00 mW (0.0 dBm). Factory set to $\pm 0.4\%$	
<b>Accuracy</b>		
N1911A/N1912A	$\pm 0.4\%$ for two years, $25 \pm 10^\circ\text{C}$	
N1913A/N1914A	$\pm 0.4\%$ for two years, $25 \pm 10^\circ\text{C}$	
E4416A/E4417A	$\pm 0.6\%$ for two years, $25 \pm 10^\circ\text{C}$	
E4418B/E4419B	$\pm 0.6\%$ for two years, $25 \pm 10^\circ\text{C}$	
<b>Frequency</b>		50 MHz (nominal)
<b>SWR</b>		
N1911A/N1912A		< 1.05:1 (typical)
N1913A/N1914A	1.08:1	< 1.05:1 (typical)
E4416A/E4417A		< 1.06:1 (nominal)
E4418B/E4419B		< 1.05:1 (nominal)
<b>Front Panel Connector</b>		Type N (f), 50 $\Omega$

## Tuned RF Level Specification Nomenclature

The tuned RF level measurement uncertainty is represented primarily by two regions. For high signal-to-noise (S/N) measurements, the uncertainty is dominated by the linearity of the measuring receiver. For low S/N measurements, the measurement uncertainty is dominated by the noise of the measuring receiver being added to the measured signal. The input power level at which the uncertainty switches from linearity dominated to noise dominated is labeled as “Residual Noise Threshold.” The minimum power level is defined as the noise floor of the measuring receiver system.

Additionally, there are 2 range-to-range change uncertainties known as “Range 2 Uncertainty” and “Range 3 Uncertainty”, respectively. Range 2 Uncertainty occurs when the measuring receiver switches from Range 1 to Range 2, and Range 3 Uncertainty from Range 2 to Range 3. They are additive uncertainties applied to all measurements whose input powers across “Range Switch Level”.

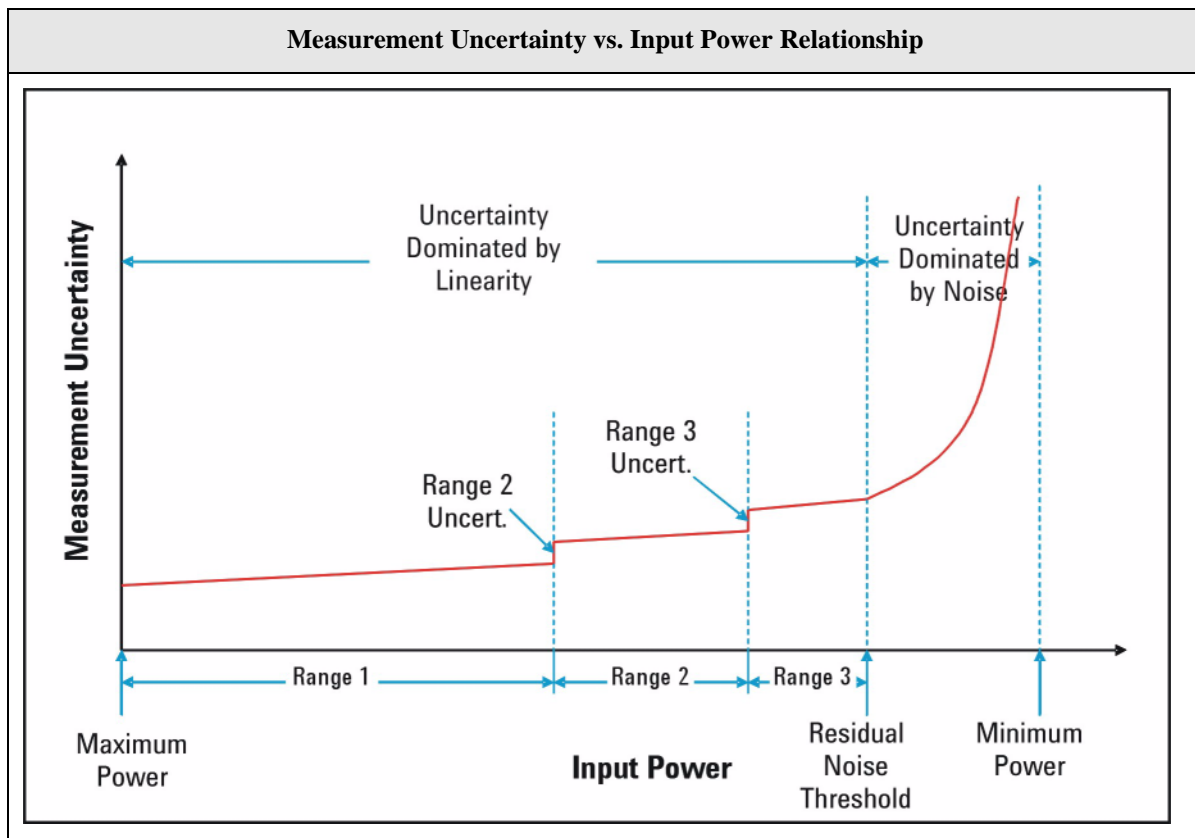

## Tuned RF Level

### Additional Definitions and Requirements

PSA Option 123 is required to perform “Tuned RF Level” measurements above 3 GHz

These specifications are valid when the measuring receiver input is a CW tone and operating temperature is within the range of 20 to 30 °C.

Absolute and relative accuracy specifications do not include mismatch uncertainty.

Specifications in the following tables apply when measuring stable frequency sources, and where the source and measuring receiver share a common frequency reference.

PSA Firmware Version  $\geq$ A.11.13 is required when using the N5532B power sensor.

PSA Firmware Version  $\geq$ A.11.21 is required when using the N1913A/N1914A power meters.

---

#### NOTE

For sources with frequency instability greater than 100 kHz, use the Tuned RF Level with Tracking measurement. When using the Tuned RF Level with Tracking measurement, the following additional amplitude error must be applied due to FFT frequency response as the signal drifts within the Tracking Range:

$\pm(0.15 \text{ dB} + 0.1 \text{ dB/MHz of span})$  to a max of  $\pm 0.40 \text{ dB}$ , where span is equivalent to the Tracking Range setting in the measurement.

The Tuned RF Level with Tracking measurement upper frequency limit = 3.05 GHz.

Minimum power =  $10 \cdot \log[\text{Integrated BW}/(75 \text{ Hz} \cdot 1.06)]$ , relative to the specified 75 Hz minimum power level.

---

Description	Specification				Supplemental Information
<b>Power Range</b>					
<b>Maximum power</b>					
Preamp off	+30 dBm				
Preamp on	+16 dBm				
<b>Minimum power (dBm)<sup>a</sup></b>	75 Hz IFBW		10 Hz IFBW <sup>b c</sup>		
<b>Frequency Range</b>					
<b>E4443A/45A/40A</b>	Preamp uninstalled	Preamp installed <sup>d</sup>	Preamp uninstalled	Preamp installed <sup>d</sup>	
100 kHz to 2 MHz	-110	-124/-110	-129	-140/-129	Band 0
2 to 10 MHz	-115	-131/-115	-134	-140/-134	Band 0
10 MHz to 3.05 GHz	-117	-134/-133	-136	-140/-140	Band 0
3.05 to 6.6 GHz	-117	-117/-127	-136	-136/-140	Band 1
6.6 to 13.2 GHz	-108	-108/-116	-127	-127/-135	Band 2
13.2 to 19.2 GHz	-100	-100/-110	-119	-119/-129	Band 3
19.2 to 26.5 GHz	-93	-93/-102	-112	-112/-121	Band 4

- a. With 30 kHz and 200 kHz IF bandwidths (IFBW), TRFL minimum power level will be degraded by a factor of  $10 \cdot \log(\text{IFBW}/75 \text{ Hz})$ , relative to the specified 75 Hz minimum power level. This will result in a degradation of 26 dB for the 30 kHz IF bandwidth and 34 dB for the 200 kHz IF bandwidth.
- b. With 10 Hz IFBW setting selected, the measurement automatically switches the IFBW to the 1 Hz setting for SNR values <10 dB.
- c. For instrument with serial number prefix below US/MY4615, the minimum power level in 10 Hz IFBW setting is 10 dB higher than the values shown here. However, if the PSA contains option 107, the values shown in the table still apply.
- d. In the frequency range of 100 kHz to 3.05 GHz, the minimum power specifications with “Preamp installed” are presented in two values: A/B, where value A is for the PSA installed with Option 1DS, and value B is for the PSA installed with Option 110. Furthermore, in the frequency range of 100 kHz and 10 MHz, Option 110 is turned off for these measurements. Option 1DS only covers frequency range of 100 kHz and 3.05 GHz, whereas Option 110 covers up to the maximum frequency of the PSA base instrument. Those two preamplifier options can not coexist in a same PSA instrument.

Measuring Receiver Personality  
Tuned RF Level

Description	Specification				Supplemental Information
<b>Minimum Power (dBm)<sup>a</sup> Frequency Range</b>	75 Hz IFBW		10 Hz IFBW <sup>b c</sup>		
	Preamp uninstalled	Preamp installed <sup>d</sup>	Preamp uninstalled	Preamp installed <sup>d</sup>	
<b>E4447A/46A/48A</b>					
100 kHz to 2 MHz	-110	-124/-110	-129	-140/-129	Band 0
2 to 10 MHz	-115	-131/-115	-134	-140/-134	Band 0
10 MHz to 3.05 GHz	-117	-134/-133	-136	-140/-140	Band 0
3.05 to 6.6 GHz	-114	-114/-126	-133	-133/-140	Band 1
6.6 to 13.2 GHz	-111	-111/-123	-130	-130/-140	Band 2
13.2 to 19.2 GHz	-109	-109/-118	-128	-128/-137	Band 3
19.2 to 26.5 GHz	-97	-97/-104	-116	-116/-123	Band 4
26.5 to 31.15 GHz	-98	-98/-103	-117	-117/-122	Band 5
31.15 to 41 GHz	-87	-87/-91	-106	-106/-110	Band 6
41 to 45 GHz	-81	-81/-81	-100	-100/-100	Band 7
45 to 50 GHz	-69	-69/-69	-88	-88/-88	Band 7

- a. With 30 kHz and 200 kHz IF bandwidths (IFBW), TRFL minimum power level will be degraded by a factor of  $10 \cdot \log(\text{IFBW}/75 \text{ Hz})$ , relative to the specified 75 Hz minimum power level. This will result in a degradation of 26 dB for the 30 kHz IF bandwidth and 34 dB for the 200 kHz IF bandwidth.
- b. With 10 Hz IFBW setting selected, the measurement automatically switches the IFBW to the 1 Hz setting for SNR values  $< 10$  dB.
- c. For instrument with serial number prefix below US/MY4615, the minimum power level in 10 Hz IFBW setting is 10 dB higher than the values shown here. However, if the PSA contains option 107, the values shown in the table still apply.
- d. In the frequency range of 100 kHz to 3.05 GHz, the minimum power specifications with “Preamp installed” are presented in two values: A/B, where value A is for the PSA installed with Option 1DS, and value B is for the PSA installed with Option 110. Furthermore, in the frequency range of 100 kHz and 10 MHz, Option 110 is turned off for these measurements. Option 1DS only covers frequency range of 100 kHz and 3.05 GHz, whereas Option 110 covers up to the maximum frequency of the PSA base instrument. Those two preamplifier options can not coexist in a same PSA instrument.



Description	Specification	Supplemental Information
<b>Linearity</b>	$\pm(0.009 \text{ dB} + 0.005 \text{ dB}/10 \text{ dB step}^a)$	Refer to “Relative Fidelity” on page 70 in the PSA base specifications for special circumstances.
<b>Relative Measurement Accuracy</b>		
Residual noise threshold <sup>b</sup> to Max power	$\pm(0.015 \text{ dB} + 0.005 \text{ dB}/10 \text{ dB step}^a)^c d$ (nom.)	
Minimum power to residual noise threshold	$\pm(\text{cumulative error}^e + 0.0012 \times (\text{Input Power} - \text{Residual Noise Threshold Power})^2)$	
<b>Residual Noise Threshold Power (dBm)</b>	Residual Noise Threshold Power = Minimum Power +30 dB	
<b>Range 2 Uncertainty<sup>f</sup></b>	$\pm 0.031 \text{ dB}$	
<b>Range 3 Uncertainty<sup>g</sup></b>	$\pm 0.031 \text{ dB}$	

- a. “Step” in this specification refers to the difference between relative measurements, such as might be experienced by stepping a stepped attenuator. Therefore, this accuracy is computed by adding the uncertainty for each full or partial 10 dB step to the other uncertainty term. For example, if the two levels whose relative level is to be determined differ by 15 dB, consider that to be a difference of two 10 dB steps. The accuracy specification would be  $\pm(0.009+2\times(0.005))$  or  $\pm 0.019 \text{ dB}$ .
- b. The residual noise threshold power is the power level at which the signal-to-noise ratio (SNR) becomes the dominant contributor to the measurement uncertainty. See the “Tuned RF Level Specification Nomenclature” section.
- c. Immediately following the system alignments, the measurement is made by manually setting frequency to that of the signal-under-test, “Accuracy” mode to “High”, and “Measure Control” to “Single”. For the E4446A/E4447A/E4448A, if the change of measured frequency crosses frequency bands, allow 10 minutes for thermal stability before taking the first measurement within the new band. (Refer to previous page in the column of “Supplemental Information” for definitions of frequency bands for the E4446A/E4447A/E4448A).
- d. This includes the linearity accuracy.
- e. In relative accuracy of TRFL measurements, the “cumulative error” is the error incurred when stepping from a higher power level to the Residual Noise Threshold Power level. The formula to calculate the cumulative error is  $\pm(0.015 \text{ dB} + 0.005 \text{ dB}/10 \text{ dB step})$ . For example, assume the higher level starting power is 0 dBm and the calculated Residual Noise Threshold Power is -99 dBm. The cumulative error would be  $\pm(0.015 + \lceil 99/10 \rceil \times 0.005 \text{ dB})$ , or  $\pm 0.065 \text{ dB}$ , where  $\lceil x \rceil$  is a ceiling function that means the smallest integer not less than x.
- f. Add this specification when the Measuring Receiver enters the “Range 2” state. Range 2 is entered when the “Range 1” signal-to-noise ratio (SNR) falls between 50 and 28 dB. The SNR value is tuning band dependent. A prompt of “Range 2” in the PSA display will indicate that the Measuring Receiver is in Range 2.
- g. Add this specification in addition to “Range 2 Uncertainty” when the Measuring Receiver software enters the “Range 3” state. Range 3 is entered when the “Range 2” SNR falls between 50 and 28 dB. The SNR value is tuning band dependent. A prompt of “Range 3” in the PSA display will indicate that the Measuring Receiver is in Range 3.

Measuring Receiver Personality  
Tuned RF Level

Description	Specification	Supplemental Information
<p><b>Absolute Measurement Accuracy</b></p> <p>Preamp Off</p> <p>+20 dBm to Max Power</p> <p>Residual Noise Threshold power to +20 dBm</p> <p>Minimum Power to Residual Noise Threshold power</p> <p>Preamp On</p> <p>Residual Noise Threshold power to +16 dBm</p> <p>Minimum Power to Residual Noise Threshold power</p> <p><b>Residual Noise Threshold Power (dBm)</b></p> <p><b>Range 2 Uncertainty<sup>c</sup></b></p> <p><b>Range 3 Uncertainty<sup>d</sup></b></p>	<p><math>\pm(\text{Power Meter Range 1 Uncert} + 0.005 \text{ dB}/10 \text{ dB Step})</math></p> <p><math>\pm(\text{Power Meter Range 2-4 Uncert} + 0.005 \text{ dB}/10 \text{ dB Step})</math></p> <p><math>\pm(\text{cumulative error}^a + 0.0012 \times (\text{Input Power} - \text{Residual Noise Threshold Power})^2)</math></p> <p><math>\pm(\text{Power Meter Range 2-4 Uncert} + 0.005 \text{ dB}/10 \text{ dB Step})</math></p> <p><math>\pm(\text{cumulative error}^b + 0.0012 \times (\text{Input Power} - \text{Residual Noise Threshold Power})^2)</math></p> <p>Residual Noise Threshold Power = Minimum Power +30 dB</p> <p><math>\pm 0.031 \text{ dB}</math></p> <p><math>\pm 0.031 \text{ dB}</math></p>	

- a. In absolute accuracy of TRFL measurements, the “cumulative error” is the error incurred when stepping from a higher power level to the Residual Noise Threshold power level. See [page 405](#) for a graphic. In order to calculate the cumulative error, you must determine the Residual Noise Threshold power and determine the Power Meter Range Uncertainty. The formula to calculate the cumulative error is:  $\pm(\text{power meter range uncertainty} + 0.005 \text{ dB}/10 \text{ dB step})$ .  
For example: the power sensor is option 504, starting power is 0 dBm and power will be stepped to -120 dBm. Therefore, the Power Meter Range Uncertainty is  $\pm 0.190 \text{ dB}$  from the table on [page 412](#). The Residual Noise Threshold Power is -106 dBm. This is calculated as follows: See Minimum Power specification on [page 408](#). Assume no preamp is installed, and that the measurement frequency is 10 MHz to 3 GHz. The Residual Noise Threshold Power is  $-136 + 30 \text{ dB} = -106 \text{ dBm}$  using the formula on [page 410](#).  
The cumulative error is then  $\pm(0.190 \text{ dB} + \lceil 106/10 \rceil \times 0.005 \text{ dB})$ , or  $\pm 0.245 \text{ dB}$ , where  $\lceil x \rceil$  is a ceiling function that means the smallest integer not less than x. That is 11 in this example.  
Note: even though the power level was stepped 120 dB (twelve 10 dB steps), the Residual Noise Threshold occurred at -106 dBm (eleven 10 dB steps).

- b. In absolute accuracy of TRFL measurements, the “cumulative error” is the error incurred when stepping from a higher power level to the Residual Noise Threshold power level. See [page 405](#) for a graphic. In order to calculate the cumulative error, you must determine the Residual Noise Threshold power and determine the Power Meter Range Uncertainty. The formula to calculate the cumulative error is:  $\pm(\text{power meter range uncertainty} + 0.005 \text{ dB}/10 \text{ dB step})$ .  
For example: the power sensor is option 504, starting power is 0 dBm and power will be stepped to -120 dBm. Therefore, the Power Meter Range Uncertainty is  $\pm 0.190 \text{ dB}$  from the table on [page 412](#). The Residual Noise Threshold Power is -110 dBm. This is calculated as follows: See Minimum Power specification on [page 408](#). Assume a preamp is installed and is On, and that the measurement frequency is 10 MHz to 3 GHz. The Residual Noise Threshold Power is  $-140 + 30 \text{ dB} = -110 \text{ dBm}$  using the formula on [page 410](#).  
The cumulative error is then  $\pm(0.190 \text{ dB} + \lceil 110/10 \rceil \times 0.005 \text{ dB})$ , or  $\pm 0.245 \text{ dB}$ , where  $\lceil x \rceil$  is a ceiling function that means the smallest integer not less than x. That is 11 in this example.
- c. Add this specification when the Measuring Receiver enters the “Range 2” state. Range 2 is entered when the “Range 1” signal-to-noise ratio (SNR) falls between 50 and 28 dB. The SNR value is tuning band dependent. A prompt of “Range 2” in the PSA display will indicate that the Measuring Receiver is in Range 2.
- d. Add this specification in addition to “Range 2 Uncertainty” when the Measuring Receiver software enters the “Range 3” state. Range 3 is entered when the “Range 2” SNR falls between 50 and 28 dB. The SNR value is tuning band dependent. A prompt of “Range 3” in the PSA display will indicate that the Measuring Receiver is in Range 3.

Measuring Receiver Personality  
Tuned RF Level

Description	Specification				Supplemental Information			
<b>Power Meter Range Uncertainty</b>					Typicals			
Power Meter Range 1 Uncertainty (dB)	Sensor module options				Sensor module options			
+20 to +30 dBm	#504	#518	#526	#550	#504	#518	#526	#550
100 kHz $\leq f_c \leq$ 10 MHz	$\pm 0.356$	–	–	–	$\pm 0.182$	–	–	–
10 MHz $< f_c \leq$ 30 MHz	$\pm 0.356$	$\pm 0.361$	–	–	$\pm 0.182$	$\pm 0.185$	–	–
30 MHz $< f_c \leq$ 2 GHz	$\pm 0.356$	$\pm 0.361$	$\pm 0.361$	$\pm 0.361$	$\pm 0.182$	$\pm 0.185$	$\pm 0.185$	$\pm 0.185$
2 GHz $< f_c \leq$ 4.2 GHz	$\pm 0.356$	$\pm 0.392$	$\pm 0.422$	$\pm 0.367$	$\pm 0.182$	$\pm 0.201$	$\pm 0.217$	$\pm 0.188$
4.2 GHz $< f_c \leq$ 18 GHz	–	$\pm 0.400$	$\pm 0.422$	$\pm 0.367$	–	$\pm 0.205$	$\pm 0.217$	$\pm 0.188$
18 GHz $< f_c \leq$ 26.5 GHz	–	–	$\pm 0.480$	$\pm 0.387$	–	–	$\pm 0.247$	$\pm 0.199$
26.5 GHz $< f_c \leq$ 50 GHz	–	–	–	$\pm 0.420$	–	–	–	$\pm 0.216$
Power Meter Range 2 Uncertainty (dB)	Sensor module options				Sensor module options			
0 to $< +20$ dBm	#504	#518	#526	#550	#504	#518	#526	#550
100 kHz $\leq f_c \leq$ 10 MHz	$\pm 0.190$	–	–	–	$\pm 0.097$	–	–	–
10 MHz $< f_c \leq$ 30 MHz	$\pm 0.190$	$\pm 0.200$	–	–	$\pm 0.097$	$\pm 0.101$	–	–
30 MHz $< f_c \leq$ 2 GHz	$\pm 0.190$	$\pm 0.200$	$\pm 0.200$	$\pm 0.200$	$\pm 0.097$	$\pm 0.101$	$\pm 0.101$	$\pm 0.101$
2 GHz $< f_c \leq$ 4.2 GHz	$\pm 0.190$	$\pm 0.255$	$\pm 0.301$	$\pm 0.212$	$\pm 0.097$	$\pm 0.130$	$\pm 0.154$	$\pm 0.108$
4.2 GHz $< f_c \leq$ 18 GHz	–	$\pm 0.267$	$\pm 0.301$	$\pm 0.212$	–	$\pm 0.136$	$\pm 0.154$	$\pm 0.108$
18 GHz $< f_c \leq$ 26.5 GHz	–	–	$\pm 0.380$	$\pm 0.247$	–	–	$\pm 0.195$	$\pm 0.126$
26.5 GHz $< f_c \leq$ 50 GHz	–	–	–	$\pm 0.297$	–	–	–	$\pm 0.152$

Description	Specification				Supplemental Information			
<b>Power Meter Range Uncertainty</b>					Typicals			
Power Meter Range 3 Uncertainty (dB)	Sensor module options				Sensor module options			
-5 to < 0 dBm	#504	#518	#526	#550	#504	#518	#526	#550
100 kHz ≤ f <sub>c</sub> ≤ 10 MHz	±0.207	–	–	–	±0.105	–	–	–
10 MHz < f <sub>c</sub> ≤ 30 MHz	±0.207	±0.216	–	–	±0.105	±0.110	–	–
30 MHz < f <sub>c</sub> ≤ 2 GHz	±0.207	±0.216	±0.216	±0.216	±0.105	±0.110	±0.110	±0.110
2 GHz < f <sub>c</sub> ≤ 4.2 GHz	±0.207	±0.268	±0.311	±0.227	±0.105	±0.136	±0.159	±0.116
4.2 GHz < f <sub>c</sub> ≤ 18 GHz	–	±0.279	±0.311	±0.227	–	±0.142	±0.159	±0.116
18 GHz < f <sub>c</sub> ≤ 26.5 GHz	–	–	±0.388	±0.241	–	–	±0.199	±0.123
26.5 GHz < f <sub>c</sub> ≤ 50 GHz	–	–	–	±0.333	–	–	–	±0.170
Power Meter Range 4 Uncertainty (dB)	Sensor module options				Sensor module options			
-10 to < -5 dBm	#504	#518	#526	#550	#504	#518	#526	#550
100 kHz ≤ f <sub>c</sub> ≤ 10 MHz	±0.421	–	–	–	±0.216	–	–	–
10 MHz < f <sub>c</sub> ≤ 30 MHz	±0.421	±0.425	–	–	±0.216	±0.219	–	–
30 MHz < f <sub>c</sub> ≤ 2 GHz	±0.421	±0.425	±0.425	±0.425	±0.216	±0.219	±0.219	±0.219
2 GHz < f <sub>c</sub> ≤ 4.2 GHz	±0.421	±0.452	±0.477	±0.431	±0.216	±0.233	±0.246	±0.221
4.2 GHz < f <sub>c</sub> ≤ 18 GHz	–	±0.458	±0.477	±0.431	–	±0.236	±0.246	±0.221
18 GHz < f <sub>c</sub> ≤ 26.5 GHz	–	–	±0.528	±0.438	–	–	±0.273	±0.225
26.5 GHz < f <sub>c</sub> ≤ 50 GHz	–	–	–	±0.491	–	–	–	±0.253

## Information about Residuals

- As the DANL (displayed average noise level) of a spectrum analyzer becomes very low, it can reveal “residuals”. These occur at discrete frequencies and arise from the various clocks and other components of the local oscillators. This is true for ALL modern spectrum analyzers. The residuals specification for the PSA Series is  $-100$  dBm. Please take this information into consideration when you measure the TRFL level below  $-100$  dBm. A user may apply a 50 ohm terminator to the PSA “RF input” connector and switch to the “spectrum analysis” mode to verify the PSA residuals.
- The power meter and sensor module (N5532A/B) combination may generate a residual of around  $-100$  dBm or lower at frequency of 50 MHz and its harmonics. Please take this information into consideration when you use the N5532A/B to measure the TRFL level below  $-100$  dBm at 50 MHz and its second or third harmonic.

Description	Specification	Supplemental Information
<b>Operating Frequency Range</b>		
E4443A/45A/40A/47A/46A/48A	100 kHz to 3 GHz	
E4443A/45A/40A/47A/46A/48A	3 to 6.7 GHz	Requires Option 123
E4445A/40A/47A/46A/48A	6.7 to 13.2 GHz	Requires Option 123
E4440A/47A/46A/48A	13.2 to 26.5 GHz	Requires Option 123
E4447A/46A/48A	26.5 to 42.98 GHz	Requires Option 123
E4446A/48A	42.98 to 44 GHz	Requires Option 123
E4448A	44 to 50 GHz	Requires Option 123
<b>Displayed Units</b>		
Absolute	Watts, dBm, or Volts	
Relative	Percent or dB	
<b>Displayed Resolution</b>	6 digits in watts or 5 digits in volts mode  0.001 dB in dBm or dB (relative) mode	
<b>Input SWR</b>	See “RF Power” on page 400.	

### Graphical Relative Measurement Accuracy Specifications (Nominal)

**E4440A, E4443A, E4445A**

IFBW = 10 Hz

PA On: Option 110 (Internal preamp) installed

Sensor Module (N5532A/B-504 or N5532A/B-526) Included

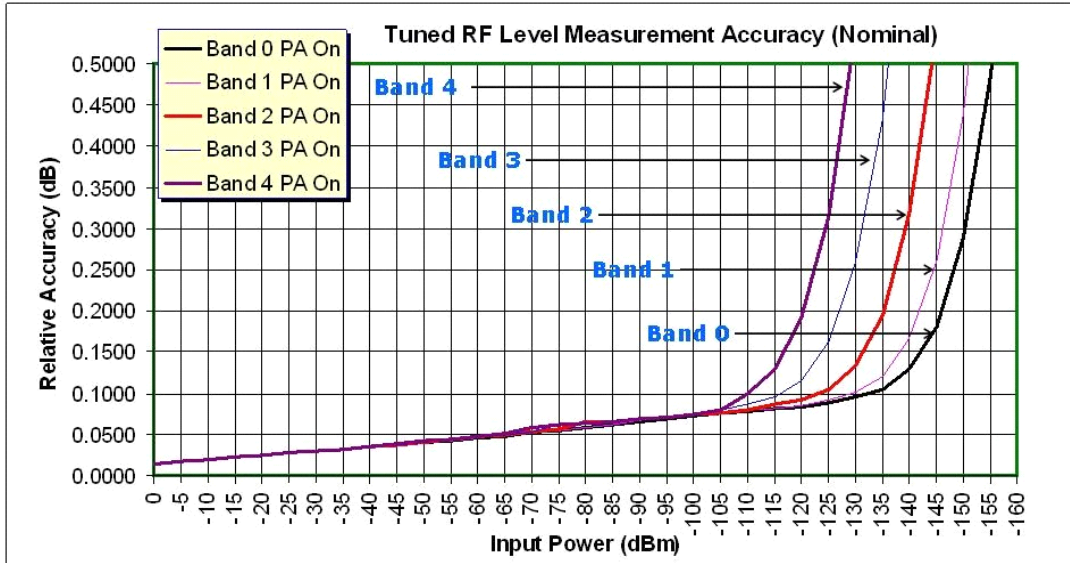

**E4446A, E4447A, E4448A**

IFBW = 10 Hz

PA On: Option 110 (Internal preamp) Installed

Sensor Module (N5532A/B-504 or N5532A/B-550) Included

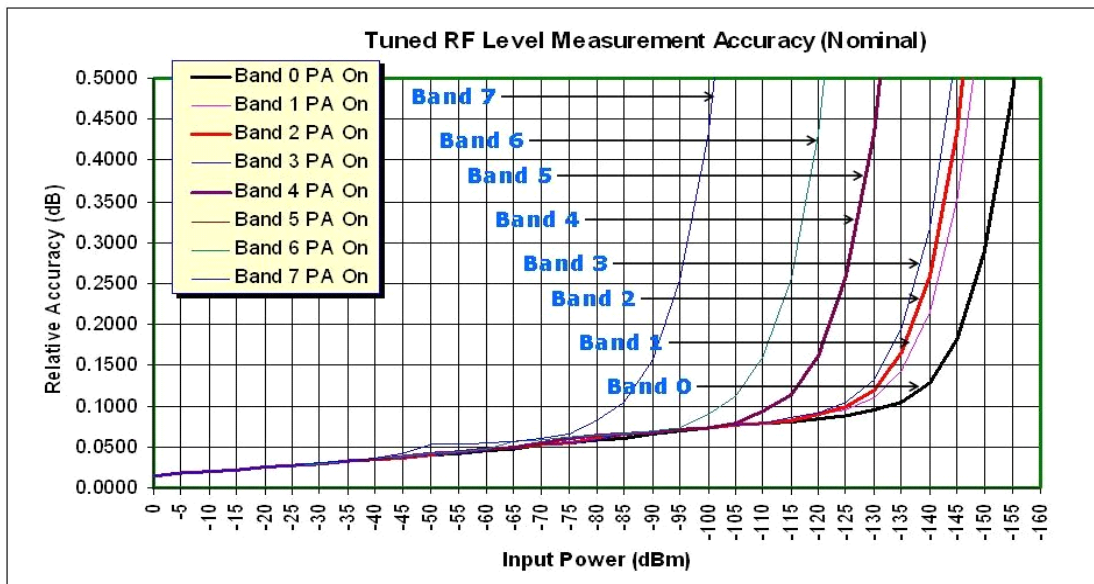

Measuring Receiver Personality  
**Tuned RF Level**